

# MISSOURI UNIFORM CRASH REPORT PREPARATION MANUAL

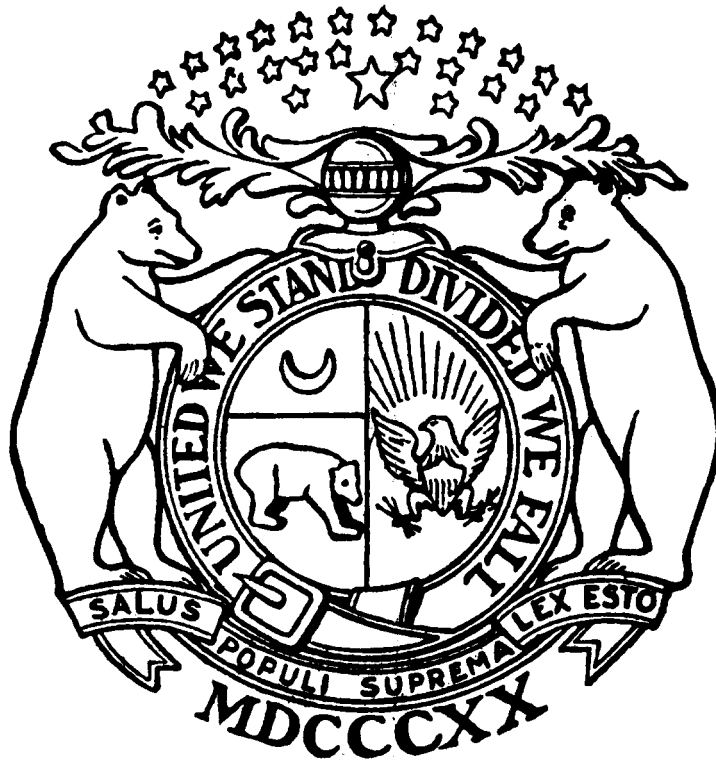

Revised  
January 1, 2019

**Prepared Under The Direction Of  
The Missouri STARS Committee**

Version 1.0





6. COLLISION DIAGRAM	Compass Direction Before Crash Event(s) (Circle One)	V1 N E S W U	V2 N E S W U	V3 N E S W U	V4 N E S W U	V5 N E S W U	V6 N E S W U
INDICATE NORTH							
INDICATE ROAD NAMES							

DIAGRAM NOT TO SCALE











# TABLE OF CONTENTS

	Page
<b>GENERAL INFORMATION</b>	
I. <a href="#">Introduction</a> .....	5
II. <a href="#">Purpose</a> .....	5
III. <a href="#">Authority</a> .....	5
IV. <a href="#">Missouri STARS Committee</a> .....	6
<b>GENERAL RULES</b>	
I. <a href="#">Reporting Criteria</a> .....	7
II. <a href="#">General Completion and Submission Procedures</a> .....	7
III. <a href="#">Collision Diagramming</a> .....	9
IV. <a href="#">Photos Taken / Reconstruction</a> .....	9
<b><a href="#">GLOSSARY OF GENERAL TERMS AND DEFINITIONS</a></b> .....	10
<b>SPECIFIC RULES FOR COMPLETING THE MISSOURI UNIFORM CRASH REPORT</b>	
Section 1 - <a href="#">General Crash Information</a> .....	25
Left the Scene / Driver No. / Cleared	25
Crash Classification	25
Report / Case / Incident Number	26
No. Veh. Inv.	26
Crash Date / Time	26
Notified Date / Time	26
Investigation Date	26
Time Arrived	26
Invest. at Scene	27
Crash Type	27
Roadway	27
Non-Collision	27
Collision Involving	28
Directional Analysis	33
Commercial Motor Vehicle Involvement Criteria	36
Evidentiary Photos Taken	37
Reconstruction	37
Section 2 - <a href="#">Location</a> .....	38
County / Municipality	38
Beat / Zone	38
Trp / Dist / Pct	38
GPS Coordinates	38
On	38
Rdwy. Dir.	40
Distance From	40
Location	40
Intersecting	41
Private Property Crash Examples	43
Speed Limit (On Street)	44
Road Maintained By	44
Speed Limit (Intersecting)	44
Int. Dir.	44
Geo Code	45
Trafficway	45
Road Alignment	46
Road Profile	46
Intersection Type	47
Road Condition	49
Road Surface	50
Weather Condition	50
Light Condition	51

Section 3 - <a href="#">Damage to Property Other Than Vehicles</a> .....	52
Section 4 - <a href="#">Witness</a> .....	52
Section 5 - <a href="#">Pedestrian</a> .....	53
NA	53
Law Enforcement Officer	53
Other Emergency Services Personnel	53
MoDOT Worker	53
Other Trafficway Worker	53
Other Pedestrian	53
No.	54
Name / Address / Phone Number	54
DOB / Sex / Struck by Veh. #	54
Inj. / Transport / Safety Devices	54
Location	54
Crossing Road	55
Other Actions	56
School Info.	57
Probable Contributing Circumstances	57
Distracted / Inattentive Codes	58
Alcohol Use	58
Section 6 - <a href="#">Collision Diagram</a> .....	59
Section 7 - <a href="#">Drivers, Vehicles, Owners, &amp; Occupants</a> .....	61
<a href="#">Page Not Used</a>	61
<a href="#">No.</a>	61
A. <a href="#">Driver</a>	61
Driver Name / Address / Phone Number	61
Driver License / ID Number / State	61
Lic. Status	62
Lic. Type	63
MC Endorsement	63
DOB, Sex, Seat Loc., Injury	64
Transport, Ejection, Air Bag, Saf. Dev.	64
Vision Obstructed	65
Insurance - Proof, Company, Phone, Policy No.	66
B. <a href="#">Vehicle</a>	66
Owner Name / Address / Phone Number	67
Vehicle Year / Make / Model / Color	67
Veh. Type	67
Total No. of Occ.	68
License - Plate No. / State / Year	68
VIN	68
Towed From Scene	68
Towed Due to Dis. Damage	69
Vehicle Damage	69
Towed By	70
Vehicle Body Types	70
GVW/GCVW Rating	74
Emergency Vehicle Involvement	76
Contributing Traffic Conditions	76

C. <u>Vehicle Action / Sequence of Events Codes</u>	77
Sequence of Events Codes	77
Animal Codes	77
Fixed Object Codes	77
Alcohol Use	78
D. <u>Probable Contributing Circumstances</u>	78
Distracted / Inattentive Codes	80
E. <u>Work Zone / Traffic Control</u>	80
Work Zone	81
Workers Present	81
Traffic Control - Electric	82
Traffic Control - Other Controls	83
Control Malfunctioning / Inoperative / Missing	84
F. <u>Occupants</u>	85
Name / Address	85
DOB, Sex, Seat Loc., Inj.	85
Transport, Ejection, Air Bag, Saf. Dev.	86
Phone Number	86
G. <u>Commercial Motor Vehicle</u>	86
Motor Carrier ID - Name / Address / Phone Number	87
Commercial / Non-Commercial	87
MC / MX / ICC No.	88
USDOT No.	88
Cargo Body Type	88
Hazardous Materials	90
Placard Displayed	90
4-Digit No.	90
Class	91
HM Cargo Present	91
HM Cargo Released	91
Hazardous Material Name	91
Section 8 - <u>Codes</u> .....	92
Seat Location	92
Injury	93
Transported	94
Ejection	95
Air Bag	95
Safety Devices	97
Vehicle Action / Sequence of Events	98
Animal	101
Fixed Object	101
Distraction / Inattention	107
Vehicle Type	108
Other Vehicle	108
Section 9 - <u>Narrative / Statements</u> .....	110
Section 10 - <u>Reporting and Reviewing Officer Information</u> .....	111
<b><u>MISSOURI UNIFORM CRASH REPORT CONTINUATION / SUPPLEMENT</u></b> .....	112
<b><u>RAILWAY VEHICLE CRASH CONTINUATION / SUPPLEMENT</u></b> .....	114
<b><u>APPENDIX A - SHORT FORM INFORMATION</u></b> .....	127

<b>APPENDIX B - <u>DIAGRAMMING METHODS</u></b> .....	128
<b>APPENDIX C - <u>UNITED STATES, CANADA, AND MEXICO ABBREVIATIONS</u></b> .....	133
<b>APPENDIX D - <u>COMMERCIAL MOTOR VEHICLES</u></b>	134
How To Find the Correct U.S. Dot/ICC # And Carrier Name	134
Guidelines for Identifying Hazardous Materials by Shipping Papers	135
<b>APPENDIX E - <u>CLASSIFYING AND LOCATING CRASHES</u></b> .....	136
Non-intersection	136
Intersections	145
Roundabouts/Traffic Circles/Connectors	153
Interchanges	156
Diamond	156
Cloverleaf	162
Diverging Diamond	165
Directional	168
Junctions	171
Bridges	173
Rest Areas / Weigh Scales	174
Reversible	176
Driveway Access	177
Parking Lots / Private Roads	178
<b>APPENDIX F - <u>MISCELLANEOUS TABLES</u></b>	184
Time Chart	184
Roadway Name Abbreviations	184
Route Designation Abbreviations	184
Color Abbreviations	185
Trafficway Cross Section	185
<b>APPENDIX G - <u>DRIVER LICENSE STATUS AND TYPE</u></b>	187

# GENERAL INFORMATION

## I. Introduction

The Statewide Traffic Accident Records System (STARS) program began in July 1971 with a grant through the National Highway Traffic Safety Administration. The purpose of STARS is to provide timely and accurate traffic crash information to federal, state, and local users in order to support both operational and management functions in traffic safety. The Missouri State Highway Patrol was selected as the statewide repository for traffic crash reports and was given the responsibility of training police officers throughout the State on completing the STARS crash report form. The Missouri State Highway Patrol provides a means for collecting, processing, and analyzing traffic crash data.

In January 1974, after approximately 2 ½ years of research, development, and testing, the Missouri State Highway Patrol Traffic Division (Patrol Records Division) began receiving crash reports on a statewide basis. The Patrol Records Division codes and classifies the reports for entry in the STARS database and supplies contributing agencies, according to their population, with monthly, semi-annual, and annual summaries of traffic crashes investigated by the agency. Each contributing agency also is supplied with a crash locator summary to assist in pin-pointing high crash locations in their area.

There have been five major revisions to STARS since its inception. These revisions have resulted in major changes to the Missouri Uniform Crash Report form, as well as field reporting procedures. To comply with Federal guidelines, revisions occurred in 1984, 1993, 1996, 2002, and January 1, 2012.

## II. Purpose

All traffic crash reports received by the Patrol Records Division are archived for permanent preservation and computerized. Where appropriate, hard copies of the reports and / or data are furnished to numerous federal, state, local, and private entities for analysis.

The Patrol Records Division is responsible for maintaining the official count of motor vehicle crash fatalities for the State of Missouri. This information, which is current to the previous midnight, is disseminated daily to other agencies through the Missouri Uniform Law Enforcement System (MULES). Without STARS, it would be almost impossible to keep an up-to-date and accurate count of traffic deaths in Missouri.

## III. Authority

STARS' authority and obligation for reporting are specified in the following Missouri statutes:

43.250. Law enforcement officers to file accident reports with patrol, when - Every law enforcement officer who investigates a vehicle accident resulting in **injury** to or death of a person, or total property **damage** to an apparent extent of five hundred dollars or more to one person, or who otherwise prepares a written or computer-generated report as a result of an investigation either at the time of and at the scene of the accident or thereafter by interviewing the participants or witnesses, shall forward a report of such accident to the superintendent of the Missouri state highway patrol within ten days after his or her investigation of the accident, except that upon the approval of the superintendent of the Missouri state highway patrol the report may be forwarded at a time and/or in a form other than as required in this section.

43.251. Report form-how provided, contents—approval by superintendent. – 1. The Missouri division of highway safety shall prepare and upon request supply to police departments, sheriffs, and other appropriate agencies or individuals forms for written accident reports as required by section 43.250 and this section. Reports shall call for sufficiently detailed information to disclose, with reference to a vehicle accident, the cause, conditions then existing and the persons and vehicles involved.

2. Every written or computer-generated accident report required to be made shall be submitted on the appropriate form or in the appropriate computer format approved by the superintendent of the Missouri state highway patrol and shall contain all the information required therein unless not available.

#### **IV. Missouri STARS Committee**

Although STARS has satisfied a great number of traffic crash data requirements since its inception, certain deficiencies were identified which limited its capability. The intent of this committee is to provide the necessary direction and coordination required to make improvements to STARS and the Missouri Uniform Crash Report.

The Standing Committee is appointed by the Superintendent of the Missouri State Highway Patrol and meets as necessary to review the crash report form and related procedures. Additional agencies may be appointed by the Superintendent.

The following agencies are currently represented on the Standing Committee:

- AAA - Automobile Club of Missouri
- Bridgeton Police Department
- Cass County Sheriff's Office
- Columbia Police Department
- Federal Highway Administration
- Federal Motor Carrier Safety Administration
- Kansas City Police Department
- Missouri Department of Health
- Missouri Department of Revenue
- Missouri Department of Transportation
- Missouri Safety Center
- Missouri Safety Council
- Missouri State Highway Patrol
- National Highway Traffic Safety Administration
- Platte County Sheriff's Department
- Poplar Bluff Police Department
- Regional Justice Information System
- St. Charles County Sheriff's Department
- St. Joseph Police Department
- St. Louis County Highway Department
- St. Louis Metropolitan Police Department
- Springfield Police Department
- Town and Country Police Department

## GENERAL RULES

### I. Reporting Criteria

Refer to the table below for STARS requirements. Incidents that meet the criteria of [deliberate intent](#), [legal intervention](#), and/or [cataclysm](#) are not considered motor vehicle crashes. When available information is insufficient to determine whether the crash was the result of [deliberate intent](#), [legal intervention](#), and/or [cataclysm](#), treat the event as a motor vehicle crash. A motor vehicle crash report may be completed as a supplement to the investigative / incident report. In these instances where a fatality occurred, a copy of the crash and/or incident report should be submitted to the Missouri State Highway Patrol, Patrol Records Division, for review.

	CLASS OF CRASH	TYPE OF REPORT FORM REQUIRED
	1. Crash involving a death or a personal injury	Long Form
	2. Property damage crashes (\$500 and above)	
	a. An emergency vehicle	Long Form
	b. Hazardous materials	Long Form
	c. Damage to government property	Long Form
	d. A <a href="#">public conveyance</a> (includes all school buses)	Long Form
	e. A driver leaving the scene of an accident	Long Form
	f. Completion of Commercial Motor Vehicle Section	Long Form
	g. A pedestrian	Long Form
	h. <a href="#">Railway vehicle</a>	Long Form
	3. All other property <a href="#">damage</a> crashes (\$500 and above)	Long or Short Form
	4. All property damage crashes less than \$500	Report not Required for STARS Entry

The short form consists of the areas on the crash report with captions or borders shaded gray or yellow. These areas are only minimum requirements. Individual departments may require additional fields to be completed for their own use. (See *Appendix A*, page 127, for a list of short form fields).

### II. General Completion and Submission Procedures

- a. All crash reports must be typed or printed legibly. Do not write the report in long hand (cursive). Computer generated report forms must be approved by the Missouri State Highway Patrol's Patrol Records Division prior to use.

LEFT THE SCENE <input checked="" type="checkbox"/> Yes <input type="checkbox"/> No	DRIVER NO. 1	CLEARED <input checked="" type="checkbox"/> Yes <input type="checkbox"/> No	CRASH CLASSIFICATION PROPERTY DAMAGE ONLY <input type="checkbox"/>	NO. INJURED 1	NO. KILLED 0	REPORT / CASE / INCIDENT NUMBER 01011200025	
NO. VEH. INV. 2	CRASH DATE 12/31/2011	CRASH TIME (MIL.) 2355	NOTIFIED DATE 01/01/2012	TIME NOTIFIED (MIL.) 0010	INVESTIGATION DATE 01/01/2012	TIME ARRIVED (MIL.) 0030	INVEST. AT SCENE <input checked="" type="checkbox"/> Yes <input type="checkbox"/> No

- b. Use an "X" in all cases where a mark is required. A checkmark (✓) is not acceptable.
- c. If a field on the crash report does not apply (not applicable), mark the "NA" box when available or neatly enter "NA" in the section. If the information for a field on the crash report is not known, mark the "Unknown" box when available or enter "UNK" or "Unknown." Every field on the report must have a response.

NO. 7A. DRIVER - NAME (Last, First, MI) & ADDRESS (Street, City, State, Zip)											PHONE NUMBER						
1 Doe, John E., 1515 North Morgan Drive, Jefferson City, MO 65201											(573) 222-5555						
DRIVER LICENSE / ID NUMBER			STATE		LIC STATUS			LIC TYPE		Operator Class		Permit		Unknown (Explain)		MC ENDORSEMENT	
None			NA		<input checked="" type="checkbox"/> NA <input type="checkbox"/> Valid <input type="checkbox"/> Susp / Rev / Denied <input type="checkbox"/> Canceled / Oth Invalid			<input type="checkbox"/> NA <input type="checkbox"/> Disqual CDL <input type="checkbox"/> Unknown		<input type="checkbox"/> NA <input type="checkbox"/> CDL Class <input type="checkbox"/> Intern / Grad		<input type="checkbox"/> MC Only <input checked="" type="checkbox"/> Unlicensed		<input type="checkbox"/> Yes <input type="checkbox"/> No <input checked="" type="checkbox"/> NA <input type="checkbox"/> Unknown (Explain)		<input type="checkbox"/> Yes <input type="checkbox"/> No <input checked="" type="checkbox"/> NA <input type="checkbox"/> Unknown (Explain)	
DATE OF BIRTH		SEX	SEAT LOC	INJ	TRANS-PORT	EJEC-TION	AIR BAG	SAFETY DEVICES	VISION OBSTRUCTED	<input type="checkbox"/> Not Obstructed	<input type="checkbox"/> Trees / Brush	<input type="checkbox"/> Sign	<input type="checkbox"/> Moving Veh	<input type="checkbox"/> Other (Explain)			
01/01/1965		M	FL	1	1	2	9	2	<input type="checkbox"/> NA	<input type="checkbox"/> Windshield	<input type="checkbox"/> Building	<input type="checkbox"/> Hillcrest	<input type="checkbox"/> Stopped Veh	<input type="checkbox"/> Unknown (Explain)			
PROOF OF INSURANCE			INSURANCE COMPANY					PHONE NO. (Optional)		POLICY NUMBER		<input type="checkbox"/> NA		<input type="checkbox"/> Driver Vehicle			
<input checked="" type="checkbox"/> Yes <input type="checkbox"/> No <input type="checkbox"/> Not Required			ABC Insuring					(314) 555-1212		Unknown				<input checked="" type="checkbox"/> Vehicle			

When completing the short form version, the "NA" or "UNK" response is necessary only in those fields required on the short form.

- d. **PAGE NOT USED** block - This block is located at the top of two pages on the report, including the second page with *Section 7 - Drivers, Vehicles, Owners, & Occupants*, and the *Narrative / Statements Continuation* page. When these page(s) are not utilized, mark the block "Page Not Used." The page(s) should be counted sequentially as part of the report; however, "NA" should not be entered in the fields.
- e. Periods should not be used in any fields except for the following:
  - i. Section 2
    - 1. GPS Coordinates
    - 2. Distance From (Miles)
    - 3. Intersecting field when entering Emergency Reference Marker Number.
    - 4. Geo-Code
  - ii. Section 7G
    - 1. Hazardous Materials Class
  - iii. Section 9 - *Narrative / Statements*
  - iv. Train Supplement
    - 1. Distance From Sign to Nearest Rail
    - 2. DOT / AAR Crossing ID. No.
- f. Indicate all dates and times on the report form as follows:
  - i. Date: Month-Day-Year (Example: January 3, 2012 should be shown as 01-03-2012). Note: All year entries must be four characters, i.e., 2010.
  - ii. Time: Records as 24-hour clock (military time). Example: Show one-thirty in the afternoon (1:30 p.m.) as 1330 hours. (See page 26 for a [conversion chart](#)).
- g. Continuation / Supplement Forms

All continuation and supplement forms must be submitted to STARS.

i. Continuation

A continuation form provided by STARS should be used when sufficient space is not available and is part of the original report. It is not necessary to repeat information; however, the report / case / incident number is required on every page of the report.

ii. Supplement

A supplement form provided by STARS should be used to report additional information not included in the original report. All header fields must be completed.

iii. Railway Vehicle Continuation / Supplement

When a [railway vehicle](#) is involved in a reportable crash, record train information on the *Railway Vehicle Continuation / Supplement*.



- h. All crash reports must be submitted to STARS within **10 days** after the initial investigation. It is imperative that fatal crashes be reported immediately to the Patrol Records Division (formerly Traffic Records Division) via MULES, followed by the completed crash report as soon as possible.
- i. Upon learning of a [late death](#), the department submitting the report will notify the Patrol Records Division (formerly Traffic Records Division) via MULES and submit an updated crash report or supplement. [Late death](#) reporting will include the date, time, and location of death. (Example: John Doe died on May 26, 2012 at 1411 hours at St. Mary's Hospital, Jefferson City, MO).
- j. Direct any problems with interpretation of this manual or the crash report form to the Missouri State Highway Patrol, Patrol Records Division, Post Office Box 568, Jefferson City, Missouri, 65102, telephone number 573-526-6113. Questions will be resolved at this level in order to ensure uniformity and consistency. Paper copies of the Missouri Uniform Crash Report should also be submitted to the aforementioned address.

### III. Collision Diagramming

- a. Each agency will determine the method of collision diagramming used, e.g., the Institute of Transportation Engineers (ITE) symbols, template drawings, computer generated drawings, or any combination. See *Appendix B*, page 128, for diagramming methods.
- b. A collision diagram **MUST** be included on all reports where enough evidence and/or facts can be obtained to adequately depict the crash scene. If a diagram is not made, write "None" in *Section 6 - Collision Diagram* and fully describe the crash in *Section 9 - Narrative and Statements*.
- c. A diagram is not necessary on the original report if a reconstruction report containing a crash diagram is submitted to STARS; however, a note (See reconstruction diagram) should be made in *Section 6: Collision Diagram*. The original report / case / incident number must be included on the reconstruction report.

### IV. Photos Taken / Reconstruction

Each agency will determine use of these fields on the report form. They are strictly optional; the information will not be entered in STARS.

## GLOSSARY OF GENERAL TERMS AND DEFINITIONS

The *Manual on Classification of Motor Vehicle Traffic Accidents*, approved by the American National Standards Institute (ANSI D16.1-2007), and the 3rd Edition of the Model Minimum Uniform Crash Criteria (MMUCC) are used to provide a common language for studying and classifying traffic crashes. Much of the information, along with many of the illustrations and photographs in this manual were derived from these publications.

Please note, the terms "accident" and "crash" have been used interchangeably and refer to the same type of incident. While use of the term "crash" has become the standard, the term "accident" continues to be used by some entities.

Some basic definitions are listed below:

[A](#) - [B](#) - [C](#) - [D](#) - [E](#) - [F](#) - [G](#) - [H](#) - [I](#) - [J](#) - [K](#) - [L](#) - [M](#) - [N](#) - [O](#) - [P](#) - [Q](#) - [R](#) - [S](#) - [T](#) - [U](#) - [V](#) - [W](#) - [X](#) - [Y](#) - [Z](#)

**ACCIDENT** – See "[Motor Vehicle Traffic Crash](#)."

**BRIDGE PARAPET** – A low wall, which runs along the outermost edge of the roadway or sidewalk on the bridge, usually composed of brick, stone, or concrete.

**BUS** - A motor vehicle with seating for transporting nine or more persons, including the driver, excluding [limousines](#). A small bus has seating for nine to fifteen persons, including the driver. A large bus has seating for sixteen or more persons, including the driver.

**CARGO** – Items being carried on or in a motor vehicle or its trailing unit. Cargo is considered part of the vehicle as long as it is in or on the vehicle, or has become dislodged from the vehicle but remains in motion. Dislodged cargo becomes an object(s), disassociated with any vehicle, once it comes to a complete stop. People in or on the vehicle are never considered cargo.

**CATAclysm** – A natural occurrence ("Act of God"). When a crash is due directly to a cataclysm, a crash has not occurred. However, if a crash occurs after a cataclysm has stopped, a crash has occurred. The following are typical definitions of cataclysms:

- **Avalanche** - A mass of snow, rock, and/or ice falling down a mountain or incline. (Source: National Weather Service)
- **Cloudburst** - An extreme rainfall sometimes mixed with hail and thunder, which normally lasts no longer than a few minutes, but is capable of creating minor flooding conditions.
- **Cyclone** - A large-scale circulation of winds around a central region of low atmospheric pressure, counterclockwise in the Northern Hemisphere. (Source: National Weather Service) The winds must be 74 mph or greater to qualify as a cataclysm.
- **Downburst** - A strong downdraft current of air from a cumulonimbus cloud and often associated with intense thunderstorms. Downdrafts may produce damaging winds at the surface. The winds must be 74 mph or greater to qualify as a cataclysm.
- **Earthquake** - Shock waves detectable and sometimes causing violent tremors at the earth's surface, generally originating by movements along deep-seated fault planes.
- **Flood** - The inundation of a normally dry area caused by an increased water level in an established watercourse, such as a river, stream, or drainage ditch. A flash flood is caused by heavy or excessive rainfall in a short period of time, generally less than six hours. Also, at times a dam failure can cause a flash flood, depending on the type of dam and time period during which the break occurs. (Source: National Weather Service)
- **Hurricane** - A tropical cyclone with surface winds in excess of 74 mph in the Western Hemisphere. (Source: National Weather Service)
- **Landslide / Mudslide**: Fast moving soil, rocks, and water that flow down hills, mountain slopes, and canyons. (Source: National Weather Service)
- **Lightning** - A visible electrical discharge produced by a thunderstorm. The discharge may occur within or between clouds, between the cloud and air, between a cloud and the ground, or between the ground and a cloud. (Source: National Weather Service)

- Tornado - A violently rotating column of air, usually pendant to a cumulonimbus cloud, with circulation reaching the ground. It nearly always starts as a funnel cloud and may be accompanied by a loud roaring noise. On a local scale, it is the most destructive of all atmospheric phenomena.
- Torrential Rain - Very heavy rain, downpours produced by a torrent. Oftentimes with raindrops of greater than 1/5" in diameter.
- Volcanic Eruption - Formed by the partial melting of existing rock and dissolved gases; the liberation of this gas and magma under considerable pressure is considered an eruption. Products of the volcanic eruption include lava flows, pyroclastic materials (volcanic glass), volcanic dust/ash, and gases.

Includes (but is not limited to):

- Any wind above the minimum speed associated with a category one hurricane (75 mph or more).
- **Damage** produced by very large hail.

Examples:

- A **motor vehicle in transport** is struck by lightning causing **damage** to the vehicle.
- A tornado, or winds in excess of 74mph, forces a tree over onto a motor vehicle in transport.
- A motor vehicle in transport is washed off a bridge during a flood.
- A landslide pushes a motor vehicle in transport off the roadway causing the vehicle to overturn.
- A motor vehicle sustains **damage** from very large rain drops during torrential rain.
- A motor vehicle in transport suffers **damage** from golf ball sized hail during a tornado.

Excludes:

- National events not listed above.

Examples:

- Rain, snow, fog, small hail, ice, smog, etc.
- Winds below the minimum speed associated with a category one hurricane (74 mph or less).
- A few small falling rocks not associated with a landslide or avalanche.
- An old tree falling only due to a rotting root system.
- Shallow standing water.

Crash Examples:

- A motor vehicle is driven into a river or creek after a bridge was washed out by a flood, and the flood has ended. The cataclysm has stopped; therefore, this would be a traffic crash.
- An earthquake buckled a road. After the earthquake stopped, a motor vehicle came along and crashed into the buckled roadway.
- A tree branch from a rotten tree, or a tree with a deteriorated root structure, falls across several motor vehicles in transport as a result of winds below 75 mph.
- A 25 mph wind propels a trash can from a city sidewalk into a passing motor vehicle.
- Power lines or an overhead traffic signal falling on a motor vehicle in transport.

**CHAIN REACTION CRASH** – When, in the same area in time and space, several motor vehicles are involved in a chain of events and the investigator is unable to determine whether there has been a stabilized situation, the chain of events should be considered a single crash.

**COMMERCIAL CARRIER** – A person, firm, corporation who is the current lessee, renter, or lawful user of the commercial motor vehicle at the time of the crash. Refer to [Appendix D](#) on page 134 for instructions on how to properly identify the carrier.

**COMMERCIAL MOTOR VEHICLE** – Any motor vehicle meeting one or more of the following criteria:

1. having a hazardous materials placard; or
2. a truck / cargo van with a GVWR / **GCVWR** of more than 10,000 lbs.; or
3. having a seating capacity of 9 or more people including the driver.

**CONSTRUCTION ZONE** – See "[Work Zone](#)."

**CRASH** – See "[Motor Vehicle Traffic Crash](#)."

**CROSSING ISLAND** – A concrete, asphalt, or grassy area in the [trafficway](#) used by pedestrians when crossing the roadway.

**DAMAGE** – Harm to property that reduces the monetary value of that property.

Includes (but is not limited to):

- Harm to domestic animals that have monetary value.
- Fire starting in a [motor vehicle in transport](#).
- Damage from an animal flying against or into a motor vehicle in transport.
- An object falling on a motor vehicle in transport.

Excludes (but is not limited to):

- Harm to animals that have no monetary value where no other property damage or [injury](#) occurs.
- Mechanical failure during normal operation, such as a tire blowout, broken fan belt, or broken axle where no other property damage or injury occurs.

**DELIBERATE INTENT** – The classification used when a person acts deliberately to cause an event. Such intended events are excluded from motor vehicle crash classification.

Includes:

- Suicide
- Self-inflicted [injury](#)
- Homicide
- Injury or damage purposely inflicted
- [Legal intervention](#)

Excludes:

- Injury or damage beyond that which was intended

**Note:** A motor vehicle that intentionally rams another motor vehicle causing [injury](#) and/or property damage is not a motor vehicle crash; however, a crash report may be completed and attached as a supplement to a criminal investigation report. If the event involves a fatality, the incident and/or crash report should be submitted to the STARS.

Examples:

- If the motor vehicle that was struck in the "Note" above loses control and collides with another motor vehicle resulting in further property damage and/or [injury](#), then a motor vehicle crash has occurred. A two-vehicle crash report should be submitted listing the vehicle that caused the first intentional event as Vehicle A, and the other two vehicles as Vehicles 1 and 2.
- A driver intentionally kills or injures himself with a motor vehicle by driving it against a fixed object or into a body of water, the driver's death or injury is a result of deliberate intent.
- A driver intentionally kills or injures another person with a motor vehicle by running into a pedestrian, the death or injury is a result of deliberate intent.
- A driver intentionally kills or injures himself with a motor vehicle by driving it against a fixed object and debris from the impact strikes a pedestrian causing serious physical injury. The injury and damage from the impact with the fixed object would be deliberate intent; however, the injury to the pedestrian goes beyond that which was intended and would be a motor vehicle crash.

**DRIVER** – The [occupant](#) in actual physical control of a vehicle during, or just prior to, the crash event.

**DRIVEWAY** – A private way that provides vehicular access to the public from a [trafficway](#) to property, parking, or loading areas outside the boundaries of the trafficway, but is considered to be not open to the public for transportation purposes as a trafficway.

Includes (but is not limited to):

- A private drive providing access to a residence, businesses, and other private entities not open to the public for transportation purposes.

Excludes:

- Privately constructed and/or maintained roads open to the public for moving persons or property from one place to another.
- [Parking lots](#)
- Entrances to businesses and other entities open to the public for transportation purposes.
- Driveway access

**DRIVEWAY ACCESS** – A driveway access is a portion of the [trafficway](#) at the end of a driveway providing access to property adjacent to a trafficway. A driveway access is not considered an intersection. See [Appendix E](#), page 177.

Includes (but is not limited to):

- Entrance to a private residence.
- Entrances to gas stations.
- Sidewalks that cross over a driveway access.
- Entrance to a [parking lot](#).

Excludes:

- Entrances, sidewalks, etc. not within the boundaries of a trafficway.

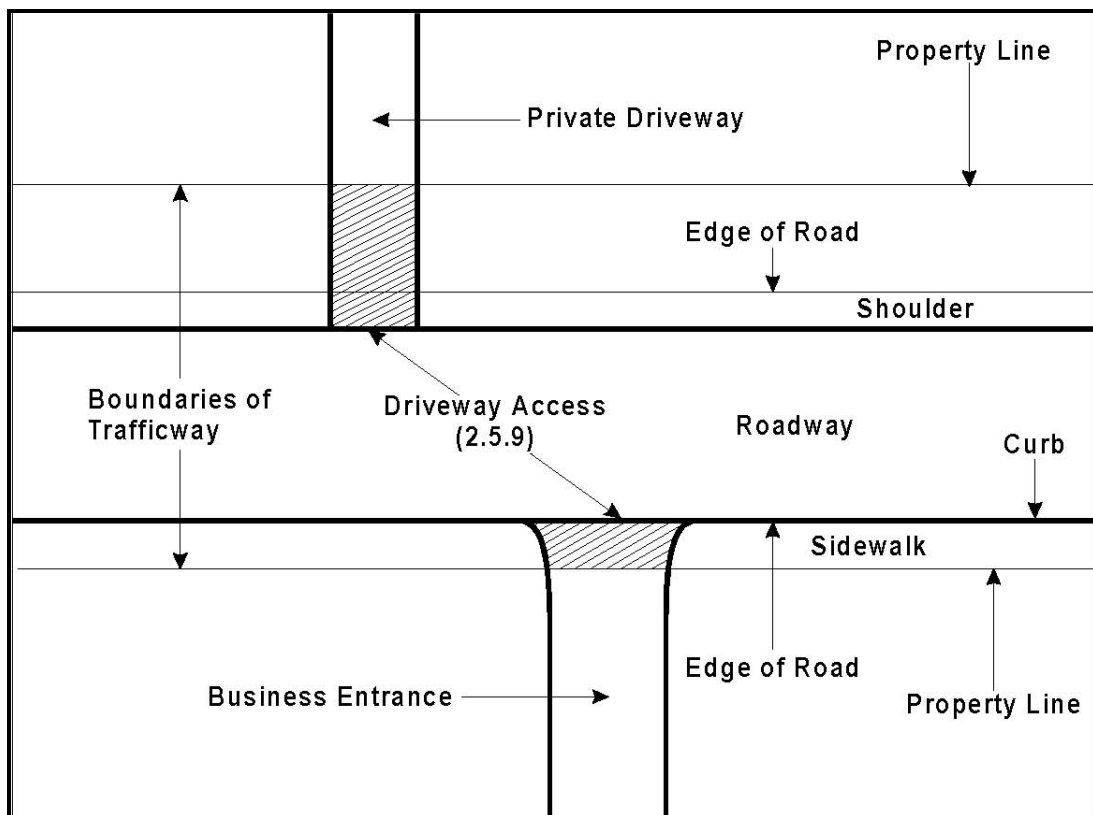

(Source: ANSI D16.1-2007 Manual on Classification of Motor Vehicle Traffic Accidents, 7th Edition)

**EMERGENCY REFERENCE MARKER (ERM)** – ERMs are located statewide on most interstate highways and are normally spaced 0.2 mile apart. **Only ERMs located on interstates can be used.** ERMs provide the direction of travel, interstate route, milepost, and tenth of a mile location. When used, crashes should be located to the nearest ERM, which should be 528 feet (0.1 mile) or less from the crash scene. See [photographs](#) on page 42.

The only exception to this distance would be in the case of a missing ERM. Missing ERM locations should not be used, rather the nearest ERM that is not missing may be used (which may be farther than 528 feet away) or the nearest roadway or bridge as listed in the [MoDOT Interactive Mapping Tool](#).

**Note:** The abbreviation "ERM" must be used as a route designation when using an emergency reference marker as the "Intersecting" street, etc. in *Section 2 - Location* of the crash report. Emergency reference markers cannot be used in the "On" subsection to locate crashes.

**FIRST HARMFUL EVENT** – The first [injury](#), death, or [damage](#)-producing event.

**FIXED OBJECT** – A fixed object is any object not in motion and attached to, or part of, the terrain.

Includes (but is not limited to):

- Any object attached to or a part of the terrain.
- Tree/stump (standing), embankment/[driveway](#)/ground/rock bluff, guardrail face, utility pole, fence, street light support, culvert, highway traffic sign post/support, bridge pier/abutment/support, curb, mailbox, concrete traffic barrier, building, traffic signal support, [impact attenuator/crash cushion](#), fire hydrant, [bridge parapet](#) end, bridge rail, guardrail end, [median](#) / other traffic barrier, overhead sign support, ditch, other posts/poles/supports, wall, cable barrier, bridge overhead structure, [work zone](#) / maintenance equipment, or overhead line/cable. Refer to [Section 8: Codes](#) on page 101 for a description of each of these objects.

**GCVWR (Gross Combined Vehicle Weight Rating)** – The combined weight ratings specified by the manufacturer for each truck and its trailing unit(s); this is not the licensed weight.

**GVWR (Gross Vehicle Weight Rating)** – The weight rating specified by the manufacturer for the vehicle; this is not the licensed weight.

**HARMFUL EVENT** – An occurrence resulting in property [damage](#), [injury](#), or death.

**IMPACT ATTENUATOR / CRASH CUSHION** – A device for controlling the absorption of energy released during a vehicle collision ("crash cushions"). Its most common application involves protection of fixed roadside objects such as bridge piers, elevated gores at exit ramps, etc. Examples include, but are not limited to, barrels filled with water or sand, plastic collapsible structures, collapsible guard rail ends, etc. See [photographs](#) on page 104.

**IN COMMERCE** – Any instance when the driver, vehicle owner, and/or carrier is involved in trade, traffic, or transportation of commodities or persons for financial consideration or exchange, or in the furtherance of a business enterprise. "In commerce" is no longer a factor to consider when determining whether to complete the *Section 7G - Commercial Motor Vehicle* section of the report.

**INJURY** – An injury is bodily harm to a person and includes fatal injury.

Includes (but is not limited to):

- Accidental poisoning from carbon monoxide generated by a [motor vehicle in transport](#).
- Breakage of a part on a motor vehicle in transport resulting in injury.
- An object unintentionally thrown towards a motor vehicle resulting in injury to the driver or [occupant](#).

Excludes:

- Injury due to a fight between occupants in a motor vehicle in transport.
- Self-inflicted injury.
- Effects of disease such as stroke, heart attack, etc.

**INTERSECTION** – An intersection consists of two or more roadways that intersect at the same level. It is an area which 1) contains a crossing or connection of two or more roadways not classified as [driveway access](#) and 2) is enclosed within the prolongation of the lateral curb lines or, if none, the lateral boundary lines of the roadways. Where the distance along a roadway between two areas meeting these criteria is less than 33 feet, the two areas and the roadway connecting them are considered to be parts of a single intersection. See [Appendix E, page 145](#) for examples.

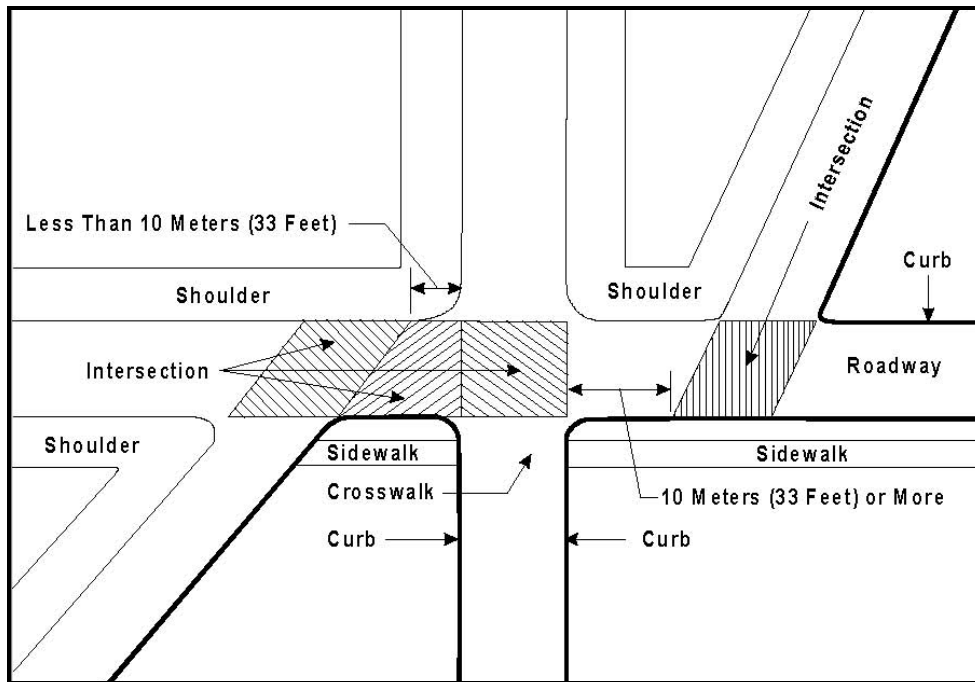

(Source: ANSI D16.1-2007 Manual on Classification of Motor Vehicle Traffic Accidents, 7th Edition)

**INTRASTATE COMMERCE** – Commerce in any state where the transit between the points of origin and termination occurs entirely within the borders of the state of origin.

**INTERSTATE COMMERCE** – Commerce in the United States where the transit between the points of origin and termination does not occur entirely within the borders of the state of origin.

**IN TRANSPORT** – In regard to motor vehicles, in-transport is the state or condition of a vehicle on a roadway or in motion within or outside the [trafficway](#). **A working motor vehicle is not considered to be “in-transport.”**

In roadway lanes used for travel during some periods and for parking during other periods, a parked motor vehicle should be considered to be in-transport during periods when parking is forbidden.

Includes (but is not limited to):

- Motor vehicle in traffic on a roadway.
- Driverless motor vehicle in motion.
- Motionless, disabled, or abandoned motor vehicle on a roadway.
- Motor vehicle in motion outside the trafficway.
- A stopped (not legally parked) motor vehicle with any portion of its primary outline as defined by the four sides of the vehicle (e.g., tires, bumpers, fenders) and load, if any, within the roadway.

Examples:

- A stopped vehicle partially on the [shoulder](#) with two tires on the roadway.
- A tractor trailer parked on the shoulder with its load hanging over the roadway edge line.
- A police vehicle patrolling or responding to an emergency.
- A police or emergency vehicle stopped on the roadway at the scene of a crash, traffic stop, or other police action, regardless of whether or not the emergency lights have been activated.
- Construction, maintenance, or utility work vehicles traveling on a trafficway from one work site to another location.
- Taxis, [limousines](#), or other passenger vehicles, with or without passengers, while on the roadway (not parked) or in-motion on a trafficway.
- A [school bus](#) stopped in a travel lane with signs and/or lights activated.
- A moving motor vehicle on a private [driveway](#).
- An ATV driving on a recreational trail inside or outside the trafficway.

- A motor vehicle (not a [working motor vehicle](#)) operating in the closed portion of the trafficway.
- A van left unattended in a lane during rush hour when parking is prohibited because it is in an open travel lane at that time.
- A tow truck on a roadway engaged in winching a vehicle from the ditch on a trafficway.
- A garbage truck stopped on the roadway being loaded with trash.
- A riding motorized lawn mower, under its own power, being driven from one home to another upon a city street.
- A tractor hauling a trailer load of corn from a farm field to a storage facility.

Excludes:

- Motor vehicle legally stopped or parked off the roadway, but within the trafficway.
- Motor vehicle stopped/parked in a parking lane or on a roadway during a period when parking is allowed.
- Transport vehicle performing construction, maintenance, or utility work on a trafficway.
- A stopped (legally parked) motor vehicle with any portion of its primary outline as defined by the four sides of the vehicle (e.g., tires, bumpers, fenders) and load, if any, not within the roadway.

Examples:

- A disabled motor vehicle legally stopped / parked on the [shoulder](#), [median](#), or roadside.
- An automobile parked in an area designated for parking against the curb of a residential street, or in a parking space/lane.
- A truck stopped on the shoulder where only the extended side-view mirror overhangs the roadway edge line.
- A paint striping highway truck in the act of painting the lines on a roadway.
- A concrete mixer discharging its load of concrete on a trafficway.
- A snow plow removing snow from an interstate highway.

**LATE DEATH** – Any death occurring on a date other than the date of the accident, within 30 days, which is a result of an [injury](#) sustained from the accident.

**LEFT THE SCENE** – A person commits the crime of leaving the scene of a motor vehicle accident when being the operator or driver of a vehicle on the highway or any publicly or privately owned [parking lot](#) or parking facility generally open for use by the public, and knowing that an [injury](#) has been caused to a person or [damage](#) has been caused to property, due to his or her culpability or to accident, he or she leaves the place of the injury, [damage](#), or accident without stopping and giving his or her name, residence, including city and street number, motor vehicle number, and operator's license number, if any, to the injured party or to a police officer, or if no police officer is in the vicinity, to the nearest police station or judicial officer. (See Section 577.060, RSMo.).

**Note:** Vehicles moved from final resting position to an area in close proximity to the crash scene for safety reasons did not leave the scene.

**LEGAL INTERVENTION** – A category of [deliberate intent](#) in which [injury](#) or [damage](#) is caused during an attempt to apprehend a law violator by a law-enforcing agent / officer. If in doing such intended acts, other injury or [damage](#) occurs that goes beyond the original intent, these events are unintentional and meet the specifications of a motor vehicle crash unless the contrary can clearly established. Remember, the law enforcement officer must intend for the act to occur.

Legal Intervention Examples:

- A road block is set up or other devices deployed to stop a lawbreaker, and the lawbreaker crashes into it either intentionally or unintentionally.
- A police car cuts in front of a car to force the car to the curb or shoulder and, as a result, the two cars collide.
- A lawbreaker loses control of his vehicle and crashes as a result of bullets fired into it from a police officer's gun.

Crash Examples:

- If a driver other than the lawbreaker crashes unintentionally into a police road block or devices deployed to stop the lawbreaker, the crash is not considered to be a result of legal intervention.
- A lawbreaker, while eluding police, loses control of his vehicle and crashes into another vehicle.



- A police car strikes a motor vehicle other than the subject of the pursuit.

**LIMOUSINE** – Any motor vehicle, other than a bus, operating [in commerce](#) having a capacity of 7-15 [occupants](#) (with the driver).

**LOW SPEED VEHICLE (LSV)** - A motor vehicle with four or more wheels whose top speed is greater than 20 miles-per-hour, but not greater than 25 miles-per-hour. LSVs are required to be equipped with basic items of safety equipment: headlamps, stop lamps, turn signal lamps, tail lamps, reflex reflectors, parking brake, windshields of either type AS-1 or AS-5 glazing, rearview mirrors, seat belts, and vehicle identification numbers (VINs).

Includes (but is not limited to):

- A conventional golf cart that was modified, after its original manufacture, so as to increase its top speed in to the 20-25 mph range.
- An originally manufactured custom golf cart (that is not a modified conventional golf cart) that has a top speed of 20 to 25 mph.

Examples:

- Neighborhood Electric Vehicle (NEV)
- Fleet golf carts sold to golf courses that have been speed-modified to increase their top speed into the 20-25 mph range.
- Personal golf carts sold to individual persons that have been speed-modified or originally manufactured to achieve a top speed of 20 to 25 mph.
- Other low speed motor vehicle designed for transport on local streets.

Excludes:

- Conventional golf cart not modified or originally custom manufactured to achieve top speeds above 20 mph.
- Automobile
- Any [personal conveyance](#)
- Any size slow moving farm tractor/equipment

Examples:

- A golf cart used solely to carry one or more people and golf equipment to play golf, sold to golf courses.
- A golf cart used to carry one or more people and may carry golf equipment to play golf, sold to individual persons who may use them to travel on trafficways to and from golf courses and to play golf, to travel on trafficways for purposes unrelated to golf, or for all of these purposes.
- A golf cart that has been speed-modified after its manufacture or originally custom manufactured to achieve top speeds greater than 25 mph.
- Motorized wheelchair
- Motorized skateboard
- Motorized handicapped scooter
- [personal conveyances](#) such as the Segway.

**MEDIAN** – A median is an area of [trafficway](#) between parallel roads separating travel in opposite directions. Flush or painted medians should be 4 or more feet wide between inside roadway edge lines. Medians fewer than 4 feet wide shall have a barrier to be considered a median. Continuous left turn lanes are not considered painted medians. See [diagram](#) on page 23.

Includes (but is not limited to):

- Physical barrier separating roads with travel in opposite directions (i.e., concrete traffic barrier, cable barrier, etc.).
- Depressed, raised, or flush area between roads with travel in opposite directions (i.e., grassy area, etc.)
- Painted median of four or more feet wide between roads with travel in opposite direction (i.e., a flushed painted median of 4 or more feet, etc.)

Excludes:

- [Shoulder](#)
- Turn lane
- Continuous left-turn lane

**MOTOR CARRIER** –The legal business entity, individual, partnership, corporation, or organization that directs, controls, and is responsible for the transportation of goods, property, or people. See [Commercial Carrier](#) on page 11

**MOTOR VEHICLE** – Any motorized (mechanically or electrically powered) device used to move persons and/or property from one place to another and is not operated on rails, operated within the confines of a building, aircraft or watercraft, a [personal conveyance](#), or a weapon. The load or [occupants](#) upon or in the motor vehicle, or a device being towed by the motor vehicle, are considered part of the motor vehicle.

Includes (but is not limited to):

- Any object being towed by the vehicle.
- Any devices detached from the vehicle while in motion.
- Any devices set in motion by a motor vehicle such as during pushing.
- The load or occupants upon or in the motor vehicle, or upon or in the device being towed or pushed. Could include persons boarding or alighting from the vehicle.
- Electrically powered buses attached to cables.
- Trolleys on highway tires.
- [Low speed vehicles](#) such as golf carts.
- Motor-driven cycles such as mopeds and miniature motorcycles (pocket bikes).
- Movable devices such as construction, agricultural, industrial, residential equipment, etc. not designed primarily for moving persons or property for transportation purposes, but being used at the time outside the confines of a building for moving persons, property, or the device itself from one place to another (i.e., transportation purposes).

Examples:

- A tow truck using its winch to pull a vehicle out of a ditch.
- Electric or telephone company truck with a "cherry picker" repairing cables on a utility pole off the [trafficway](#).
- A road grader going from one work site to another.
- Garbage truck being loaded with trash.
- A riding motorized lawn mower, under its own power, being driven from one home to another upon a city street.

Excludes:

- Devices operated on rails.
- Devices operated within the confines of a building.
- Motorized [personal conveyances](#).
- Movable devices such as construction, agricultural, industrial, residential equipment, etc. being used at the time within the confines of a building or **not** being used for moving persons, property, or the device itself from one place to another (i.e., transportation purposes).
- Aircraft
- Watercraft

Examples:

- Motorized skateboard
- Motorized toy car
- Motorized wheelchairs or handicapped devices.
- Segway-style devices.
- Forklift operated within the confines of a building.
- Riding motorized lawn mower mowing a residential lawn off the trafficway.

**MOTOR VEHICLE IN TRANSPORT** – The state or condition of a vehicle when it is being used for moving persons or property (including the vehicle itself) from one place to another, and is:

1. In motion; or
2. In readiness for motion; or
3. On a roadway, but not parked in a designated area.

Examples: motor vehicle in traffic on a highway; driverless motor vehicle in motion; motionless motor vehicle abandoned on a roadway; disabled motor vehicle on a roadway; etc. In roadway lanes used for travel during rush hours and parking during off-peak hours, a parked motor vehicle is **in transport** during periods when parking is forbidden.

**MOTOR VEHICLE TRAFFIC CRASH** – Any motor vehicle crash in which the unstabilized situation originates on a **trafficway** or a **harmful event** occurs on a trafficway. If an unstabilized set of events originates and terminates off a trafficway and no harmful event occurs on a trafficway, the event is a motor vehicle crash but not a motor vehicle traffic crash. Both motor vehicle crashes and motor vehicle traffic crashes are included in STARS; however, STARS statistics only include motor vehicle traffic crashes.

To have a motor vehicle crash, the following elements must be present:

1. Involvement of at least one **motor vehicle in transport**.
2. At least one harmful event.
3. The harmful event must be the result of an unintentional act.
4. The harmful event is not the direct result of a cataclysm.
5. The crash was not initiated by an action of an aircraft or watercraft.
6. The crash does not include any harmful event involving a **railway vehicle in transport** prior to involvement of a motor vehicle in transport.

**Note:** If there is an intentional act with a motor vehicle resulting in a fatality, a motor vehicle crash report may be completed as a supplement to the investigative / incident report. In these instances a copy of the crash and/or incident report should be submitted to the Missouri State Highway Patrol, Patrol Records Division, for review.

A collision involving a wild animal, i.e., having no monetary value, where no other **damage** is sustained is not a motor vehicle crash. Conversely, a collision involving a domestic animal with monetary value would be a motor vehicle crash regardless of any other **damage** sustained.

**MOTORCYCLE** - Any motor vehicle having a seat or saddle for the use of its operator and traditionally designed to travel on not more than three wheels in contact with the ground. Non-traditional designs exist with more than three wheels and these may be considered a motorcycle. See page 72

**NONCONTACT VEHICLE** – A noncontact vehicle is one in which the vehicle contributes to a crash without contact. A noncontact vehicle indirectly involved in a crash should not be counted as one of the vehicles involved and should not be listed in Section 7 - Drivers, Vehicles, Owners, & Occupants. The involvement of noncontact vehicles should be explained in the narrative and identified as "Vehicle A," "Vehicle B," etc., in Section 6 – *Collision Diagram* and Section 9 – *Narrative / Statements*.

Examples:

- A vehicle changes lanes into the path of another vehicle (without making contact) causing a crash. The vehicle changing lanes is a noncontact vehicle.
- A vehicle exiting a private drive fails to yield to an oncoming vehicle on a city street. In an attempt to avoid a collision, the oncoming vehicle skids off the roadway and collides with a utility pole. The vehicle exiting the private drive is a noncontact vehicle.

**NUMBER OF VEHICLES INVOLVED IN A CRASH** – The number of motor vehicles as well as **other transport devices** directly involved in a traffic crash before the situation stabilizes. Any subsequent contact after the situation stabilizes constitutes a separate crash.

An object set in motion by a motor vehicle or other transport device is considered an extension of the vehicle and will be treated as such. **EXAMPLE:** An object falls from or is set in motion by a moving vehicle causing **damage** to a second or multiple vehicles before the object comes to rest and stabilizes. Record this as a two-vehicle or

multiple-vehicle crash. **Note:** A motor vehicle is not considered an "object" for the purposes of this definition and, consequently, is not considered an extension of the striking vehicle. A motor vehicle put in motion when struck by a [motor vehicle in transport](#) or other transport device is considered a vehicle involved in the crash.

When a vehicle and / or its driver contribute to a crash without contact, include them in *Section 6 – Collision Diagram* and *Section 9 – Narrative / Statements*, identifying them as "Vehicle A," "Vehicle B," etc. Do not include these vehicles in the "Number of Vehicles Involved" box.

Vehicles involved in the same [unstabilized event](#), which sustain [damage](#), but do not strike each other are both included in the number of vehicles involved in a crash. For example, a westbound vehicle goes out of control and an eastbound vehicle runs off the road while avoiding the westbound vehicle. The westbound vehicle runs off the road and strikes a rock bluff and the eastbound vehicle also runs off the road and strikes an embankment. Neither vehicle strikes the other; however, since both vehicles sustained [damage](#) (both were involved in a [harmful event](#)) during the same unstabilized situation, the event is a single motor vehicle crash involving two motor vehicles.

**OCCUPANT** – Any person who is in or on a vehicle. Note: Occupants ejected from a vehicle and hit (prior to stabilization) are still part of the vehicle.

**OPERATOR** – See "[Driver](#)"

**OTHER TRANSPORT DEVICE** – A device other than a motor vehicle; [personal conveyance](#); aircraft; watercraft; weapon; or a device used within the confines of a building and its premises that is designed to move persons or property, along with the device itself, from one place to another for **transportation purposes**.

Includes:

- [Pedalcycle](#) with pedalcyclist
- Animal-drawn vehicle
- Animal harnessed to a conveyance
- Animal carrying a person

**PARKED MOTOR VEHICLE** – A motor vehicle not in-transport, other than a [working motor vehicle](#), that is not in motion and not located on the roadway. A "parked motor vehicle" should be considered to be in-transport during periods when parking is prohibited in roadway lanes used for travel during some periods and for parking during other periods. For further information and [examples](#), see page 31.

**PARKING LOTS** - An area used primarily for parking road vehicles. When paved and marked it commonly includes parking stalls, parking lot aisles, and parking lot ways. See [Appendix E](#), page 178 for examples.

**PARKING LOT AISLES** - Areas used primarily for vehicular access to parking stalls. Parking lot aisles are not trafficways. See [Appendix E](#), page 178 for examples.

**PARKING LOT WAY** - Land ways used primarily for vehicle circulation within parking lots and for vehicular access to parking lot aisles. Parking lot ways in parking lots open to the public are trafficways. See [Appendix E](#), page 178 for examples.

**PARKING STALLS** - Areas reserved primarily for parked road vehicles. Parking stalls are not trafficways. See [Appendix E](#), page 178 for examples.

**PEDALCYCLE** – A non-motorized device operated solely by pedals propelled by human power. See page 28 for [more information](#).

**PEDESTRIAN** – Any person who is not an [occupant](#), in or on, a vehicle. For further information and [examples](#), see page 30.

**PERSONAL CONVEYANCE** – A device other than a motor vehicle, aircraft, watercraft, [railway vehicle](#), or [pedalcycle](#) used by a pedestrian for personal mobility assistance or recreation. These devices can be motorized or human powered, but not propelled by pedaling.

Includes (but is not limited to):

- Rideable Toys
  - Roller skates, in-line skates
  - Skateboard
  - Toy Car
  - Baby Carriage
  - Scooter
  - Toy Wagon
- Motorized Rideable Toys
  - Motorized Skateboard
  - Motorized Toy Car
- Devices for Personal Mobility Assistance
  - Segway-style Device
  - Motorized and Non-motorized Wheelchair
  - Handicapped Scooter

Excludes:

- Golf Cart
- [Low Speed Vehicle](#) (LSV)
- Go-carts
- Minibike
- "Pocket" Motorcycle
- Motor Scooter
- Moped

**PUBLIC CONVEYANCE** – A motor vehicle, either publicly or privately owned, engaged in the business of passenger transportation services. This includes, but is not limited to, buses, taxis, [limousines](#), and shuttle services with or without passengers at the time of the crash. Private car pooling is not included under this definition.

**RAMP** – An auxiliary roadway used for entering or leaving through-traffic lanes at interchanges. Ramps will be identified in the [MoDOT Interactive Mapping Tool](#) by a unique number and have a designation of RP.

**Note:** Access to weigh scales (WS) and rest areas (RA) are not ramps.

**RAILWAY VEHICLE** – Any device, with or without coupled cars, designed for transport on a railway. Includes any device designed to operate on railway tracks under its own power, such as a motor vehicle equipped with flange wheels. A non-motorized device, unattached from the power unit, or not set motion by a power unit, is not a railway vehicle, e.g., boxcar sitting on rails not attached to an engine is an "Other Object."

**REVERSIBLE LANES** – Reversible lanes are those that the direction of travel is reversed at certain designated times.

**ROAD** – That part of a [trafficway](#) including both the roadway and any [shoulder](#) alongside the roadway. See [diagram](#) on page 23.

**ROADWAY** – The part of a [trafficway](#) designed, improved, and ordinarily used for vehicular travel. See [diagram](#) on page 23.

Note:

- The roadway is the traveled portion of the trafficway.
- An undivided trafficway has one roadway.
- A divided highway or expressway has more than one roadway, one for each direction of travel.
- The [shoulder](#) is not considered a part of the roadway.

**SAFETY DEVICE** – A device used to restrain, protect, and/or identify vehicle drivers / [occupants](#) and/or [pedestrians](#) to minimize likelihood of [injury](#).

**SCHOOL BUS** – Any motor vehicle used for transporting school pupils at or below the 12<sup>th</sup> grade level, to or from a public or private school, or school-related activity, or going to pick up or returning from delivering school pupils, and only if it is externally identifiable by the following characteristics:

1. Yellow in color
2. The words "school bus" on front and rear
3. Equipped with flashing red lights on front and rear
4. Lettering on both sides identifying the school or district served, or company operating the bus.

A motor vehicle is NOT a school bus while it is being used to transport non-school pupils, on trips which involve the transportation exclusively of other passengers such as senior citizens or migrant workers, or exclusively for purposes other than the transportation of school pupils.

**SEPARATOR** – The area of a [trafficway](#) between parallel roads separating travel in the same direction or separating a frontage road (outer road or service road) from other roads. See [diagram](#) on page 23.

Includes (but is not limited to):

- Physical barrier separating roads with travel in the same direction (i.e., concrete or cable barrier, etc.).
- Physical barrier separating a frontage road from other roads of a trafficway (i.e., concrete or cable barrier, etc.).
- Depressed, raised, or flush area between roads with travel in the same direction.
- Depressed, raised, or flush area between a frontage road and other roads of a trafficway.

Excludes:

- [Shoulder](#), [Median](#)

**SHORT FORM FIELDS** – These fields have captions or borders shaded gray. (See page 127 for list of [fields](#)).

**SHOULDER** – The part of the [trafficway](#) contiguous with the [roadway](#) which may accommodate stopped vehicles, emergency use, or lateral support of the roadway structure. See [diagram](#) on page 23.

Note:

- The shoulder is not considered part of the roadway.
- The shoulder and the roadway combine to make up the road.
- The line between the roadway and shoulder may be a painted edge line, a change in surface color or material, or a curb.

**STABILIZED EVENT** – Marks the end of an [unstabilized event](#). This generally occurs when persons and property come to final rest, and nothing further will occur insofar as the event itself is concerned. Another unstabilized event may follow because of subsequent actions closely related to the first event; however, it should be treated as a separate event.

**TRAFFICWAY** – The entire width between property lines, or other boundary lines, of every way or place, other than an airway or waterway, of which any part is open to the public as a matter of right or custom and used for moving persons or property from one place to another. See [diagram](#) on page 23

- Airway - A transport way reserved primarily for use by aircraft taking off, in flight, or landing.
- Waterway - A transport way reserved primarily for use by watercraft.

Includes (but is not limited to):

- Areas within guarded entrances, such as military posts or private residential developments, are trafficways provided the guards customarily admit public traffic.
- Privately constructed and/or maintained roads open to the public for moving persons or property for transportation purposes.
- Local roads in a residential development open to the public.
- Land way providing vehicular access and/or circulation from a trafficway to a business open to the public.

- **Parking lot ways.** See example in [Appendix E](#), page 178.

Excludes:

- Areas under construction are not a trafficway if traffic is prohibited from entering by signing or barriers, which are in conformance with applicable standards. However, if any part of the trafficway is open to traffic while the remainder is closed, the part that is open is a trafficway. Likewise, any temporary bypass of a construction site is a trafficway.
- A trafficway temporarily closed to travel and marked by signing or barriers, which are in conformance with applicable standards, is not a trafficway even though used by authorized vehicles, such as maintenance vehicles, or when intentionally or inadvertently used by unauthorized vehicles. A trafficway open only to local traffic is **not** considered closed.
- Roads in a gated community only open to residents and their guests.
- Land ways not open to the public.
- Parking spaces and parking aisles. See example in [Appendix E](#), page 178.

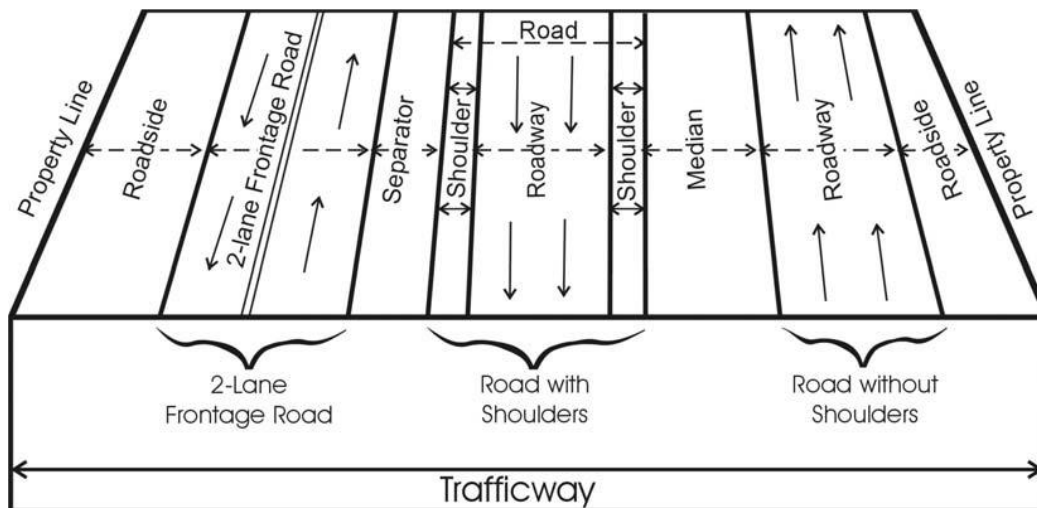

(Source: ANSI D16.1-2007 Manual on Classification of Motor Vehicle Traffic Accidents, 7th Edition)

**TRUCK TRACTOR** – A motor vehicle consisting of a single motorized transport device primarily designed for pulling semi-trailers.

**UNSTABILIZED EVENT** – An event, or set of events, that originates when control is lost and terminates when control is regained; or in the absence of persons who are able to regain control, when all persons and property are at rest.

**Note:** If thorough investigation fails to establish whether a crash scene is the result of one or more unstabilized events, then it should be treated as a single unstabilized event. For instance, a [chain reaction crash](#) in which stabilization cannot be determined.

Examples:

- In a motor vehicle crash live electric wires fall on a motor vehicle, but there is no **injury** from the electric current while the **occupants** remain in the motor vehicle. The unstabilized event ends with the occupants in a temporary position of safety. Any subsequent injury resulting from attempts by the occupants to leave the motor vehicle, or attempts by others to rescue the occupants is part of a new unstabilized event.
- In a motor vehicle crash the occupants of the motor vehicle are carried or thrown into water, but there is no **injury** from the submersion and the occupants reach a temporary position of safety. At this point, the unstabilized event has ended. Any subsequent injury from attempts by the occupants to reach shore, or from attempts by others to rescue the occupants is part of a new unstabilized event.
- In a motor vehicle crash the motor vehicle catches on fire and is burning, but all occupants have been rescued and the fire is under control. No additional property **damage** is expected. This is the end of the

unstabilized event. If the heat of the fire ignites nearby combustible materials, any subsequent [injury](#) or [damage](#) from the induced ignition is not part of the original unstabilized event.

- A [pedestrian](#) is struck by a [motor vehicle in transport](#). The pedestrian comes to rest in the [roadway](#). Any subsequent [injury](#) resulting from contact with another motor vehicle in transport is part of a new unstabilized event.
- A pedestrian is struck by a motor vehicle and thrown into the path of another motor vehicle and the pedestrian is struck a second time before coming to rest. There is only one unstabilized event.
- A motor vehicle in transport brakes in an attempt to avoid a pedestrian crossing the roadway; however, the motor vehicle strikes the pedestrian. At the same time (i.e., when the first motor vehicle started to brake and before it came to rest), a second motor vehicle in transport swerves to avoid a collision with the braking vehicle and strikes a utility pole. The two motor vehicles in transport did not strike each other, but these events are all within one unstabilized event.

**VEHICLE** – Any device including motor vehicles and [other transport devices](#) designed primarily for moving persons or property, along with the device itself, from one place to another.

**WORKING MOTOR VEHICLE** – A motor vehicle in the act of performing construction, maintenance, or utility work related to the [trafficway](#). This "work" may be located within open or closed portions of the trafficway and motor vehicles performing these activities can be within or outside of the trafficway boundaries. For instance, a utility truck parked off the trafficway in a field placing a concrete culvert on the trafficway. See page 32, [Working MV](#), for inclusions and exclusions.

**WORK ZONE** – A work zone is an area of a [trafficway](#) where construction, maintenance, or utility work activities are identified by warning signs/signals/indicators, including those on transport devices (e.g., signs, flashing lights, channelizing devices, barriers, pavement markings, flagmen, warning signs and arrow boards mounted on the vehicles in a mobile maintenance activity) that mark the beginning and end of a construction, maintenance, or utility work activity.

A work zone extends from the first warning sign, signal, or flashing lights to the "End Road Work" sign or the last traffic control device pertinent for that work activity.

Work zones also include [roadway](#) sections where there is ongoing, moving (mobile) work activity such as lane line painting/markings or roadside mowing only if the beginning of the ongoing, moving (mobile) work activity is designated by warning signs or signals.



# SPECIFIC RULES FOR COMPLETING THE MISSOURI UNIFORM CRASH REPORT

## I. SECTION 1 - GENERAL CRASH INFORMATION

This section is used to record general information about the crash.

MISSOURI UNIFORM CRASH REPORT										PAGE _____ OF _____					
1 - GENERAL CRASH INFORMATION							AGENCY NAME AND ORI								
SPACE USED FOR BARCODE															
LEFT THE SCENE		DRIVER NO.		CLEARED		CRASH CLASSIFICATION		PROPERTY DAMAGE ONLY		NO. INJURED	NO. KILLED	REPORT / CASE / INCIDENT NUMBER			
<input type="checkbox"/> Yes <input type="checkbox"/> No				<input type="checkbox"/> Yes <input type="checkbox"/> No				<input type="checkbox"/>							
NO. VEH. INV.	CRASH DATE		CRASH TIME (MIL.)		NOTIFIED DATE		TIME NOTIFIED (MIL.)		INVESTIGATION DATE		TIME ARRIVED (MIL.)	INVEST. AT SCENE			
												<input type="checkbox"/> Yes <input type="checkbox"/> No			
CRASH TYPE	ROADWAY		NON-COLLISION			COLLISION INVOLVING				DIRECTIONAL ANALYSIS FOR IMPACT WITH MOTOR VEHICLE					
	<input type="checkbox"/> On Roadway <input type="checkbox"/> Off Roadway		<input type="checkbox"/> Overturning <input type="checkbox"/> Fire / Explosion <input type="checkbox"/> Immersion <input type="checkbox"/> Jackknife			<input type="checkbox"/> Fell/Jumped From MV <input type="checkbox"/> Cargo / Equip Loss / Shift <input type="checkbox"/> Other Non-Collision <input type="checkbox"/> Animal <input type="checkbox"/> Pedalcycle <input type="checkbox"/> Fixed Object <input type="checkbox"/> Other Object <input type="checkbox"/> Pedestrian				<input type="checkbox"/> Railway Vehicle <input type="checkbox"/> Animal Drawn Veh / Animal Ridden Trans. <input type="checkbox"/> Motor Vehicle in Transport <input type="checkbox"/> Parked Motor Vehicle <input type="checkbox"/> Working Motor Vehicle				<input type="checkbox"/> Front to Front <input type="checkbox"/> Front to Rear <input type="checkbox"/> Rear to Rear <input type="checkbox"/> Rear to Side <input type="checkbox"/> Angle <input type="checkbox"/> Sideswipe (Same Dir.) <input type="checkbox"/> Sideswipe (Opp. Dir.) <input type="checkbox"/> Falling / Shifting Cargo (Set in motion by MV) <input type="checkbox"/> Other (Explain) <input type="checkbox"/> Unknown (Explain)	
COMMERCIAL MOTOR VEHICLE INVOLVEMENT CRITERIA - Answer the following to determine if the "Commercial Vehicle" fields in Section 7G must be completed.															
1. Does this crash involve any of the following? 1a. A person fatally injured; OR 1b. A person transported for medical attention; OR 1c. A vehicle towed due to disabling damage.						<input type="checkbox"/> No - No commercial vehicle fields need completion. <input type="checkbox"/> Yes - Go to number 2. →			2. Examine each vehicle to determine if it is a commercial vehicle based upon the following: 2a. A truck / cargo van with GVWR / GCVWR of more than 10,000 lbs; OR 2b. A motor vehicle with seating for 9 or more including driver; OR 2c. A vehicle with a hazardous materials placard.				<input type="checkbox"/> No - No commercial vehicle fields need completion. <input type="checkbox"/> Yes - Complete Section 7G for appropriate vehicle.		
EVIDENTIARY PHOTOS TAKEN			BY WHOM			AVAILABLE FROM						<input type="checkbox"/> Investigating Agency			
<input type="checkbox"/> Yes <input type="checkbox"/> No															
RECONSTRUCTION			BY WHOM			AVAILABLE FROM						<input type="checkbox"/> Investigating Agency			
<input type="checkbox"/> Yes <input type="checkbox"/> No															

- a. **PAGE \_\_\_\_ OF \_\_\_\_** - The first blank is the page number and the second is the total number of pages. Number additional pages using the same format.
- b. **AGENCY NAME AND ORI** - Enter agency name and Originating Agency Identifier (ORI) number. Other information pertinent to the department may be shown here.
- c. **LEFT THE SCENE** - Mark "Yes" if one or more of the drivers involved [left the crash scene](#) as defined in the glossary.
- d. **DRIVER NO.** - Enter the assigned number of the driver(s) who [left the scene](#). Up to four can be shown. If more than four drivers left the scene, list additional vehicle/driver number(s) in the narrative.
- e. **CLEARED** - Complete this section if "Left the Scene" is marked "Yes." Each agency will use its own criteria to determine cleared status.  
  
**Yes** - Mark "Yes" if the status of the "Left the Scene" crash is cleared according to agency criteria.  
  
**No** - Mark "No" if the status of the "Left the Scene" crash is not cleared.
- f. **CRASH CLASSIFICATION**

**Note:** When there are no deaths, injuries, or property [damage](#), there is no crash.

**Property Damage Only** - Mark when no person is injured or killed.

**No. Injured** - Show the number of persons injured (Person Injury Code 2 to 4) in the crash. See page 93 for a description of the [injury codes](#). Do not include fatalities.

**No. Killed** - Show the number of persons killed (Person Injury Code 1) in the crash. See page 93 for a description of the [injury codes](#). A number in this space indicates a fatal crash.

- g. **REPORT / CASE / INCIDENT NUMBER** – Enter report, case, or incident number assigned by the submitting agency, if applicable.
- h. **NO. VEH. INVOLVED** – (Number of Vehicles Involved) Include number of vehicles involved in the crash; exclude [pedestrians](#) and [personal conveyances](#). Vehicles, pedestrians, and [personal conveyances](#) are defined in the glossary.

**Note:** There must be at least one [motor vehicle in transport](#) in the crash.

A motor vehicle or [other transport device](#) is involved in a crash only when:

- i. it has sustained or caused [damage](#), and / or
- ii. at least one of its [occupants](#) was injured or killed, or
- iii. the motor vehicle in transport struck a pedestrian.

- i. **CRASH DATE** - Enter date the crash occurred. (Use MM-DD-YYYY format).
- j. **CRASH TIME** - Using military time, enter time the crash occurred (see [General Rules](#) on page 8 for proper format). Valid times are 0000 through 2359; 2400 is NOT a valid time.

### TIME CHART

ORDINARY TIME	MILITARY TIME	ORDINARY TIME	MILITARY TIME
1 a.m.-----	0100	1 p.m.-----	1300
2 a.m.-----	0200	2 p.m.-----	1400
3 a.m.-----	0300	3 p.m.-----	1500
4 a.m.-----	0400	4 p.m.-----	1600
5 a.m.-----	0500	5 p.m.-----	1700
6 a.m.-----	0600	6 p.m.-----	1800
7 a.m.-----	0700	7 p.m.-----	1900
8 a.m.-----	0800	8 p.m.-----	2000
9 a.m.-----	0900	9 p.m.-----	2100
10 a.m.-----	1000	10 p.m.-----	2200
11 a.m.-----	1100	11 p.m.-----	2300
Noon-----	1200	Midnight-----	0000

**Note:** For 12:00 a.m. to 12:59 a.m., the hour is "00." For example, for 12:33 a.m., the time is shown as "0033" hours. Do not use colons with military time.

- k. **NOTIFIED DATE** - Enter date the officer was notified of the crash. (Use MM-DD-YYYY format).
- l. **TIME NOTIFIED** - Using military time, enter time the officer was notified, witnessed, or discovered the crash.  
  
**Note:** Date and time notified cannot be before date and time of the crash.
- m. **INVESTIGATION DATE** - Enter date the officer initiated the investigation. (Use MM-DD-YYYY format).
- n. **TIME ARRIVED** - Using military time, enter time the officer arrived at the scene of the crash.

**Note:**

- Enter the same time in "Crash Time," "Time Notified," and "Time Arrived" fields when the officer witnesses the crash.

- Enter the same time in "Time Notified" and "Time Arrived" fields when the officer discovers the crash scene before being notified.
  - Enter "NA" if the officer does not go to the crash scene.
  - "Investigation Date" and "Time Arrived" cannot be before date and time notified.
- o. **INVEST. AT SCENE** - Mark "Yes" if **any** on-scene investigation was made (even if the investigation at the scene was conducted after all vehicles, etc. are removed).
- p. **CRASH TYPE** - Classifies motor vehicle crashes by type of occurrence associated with the **first harmful event**.
- i. **ROADWAY** - Crashes are categorized in relation to **roadway** at the time of the **first harmful event**.
1. **On Roadway** - Mark if the first harmful event occurred on the roadway.
 

**Note:** If the first harmful event involves a "**Parked Motor Vehicle**," then "Off-Roadway" must be marked.
  2. **Off Roadway** - Mark if the first harmful event occurred off the roadway.
- ii. **NON-COLLISION** - A crash involving a **motor vehicle in transport** in which the **first harmful event** occurs in a manner other than collision.
1. **Overturning** - A motor vehicle that has overturned at least 90 degrees to its side.
  2. **Fire / Explosion** - A fire / explosion that was the first harmful event. (Make certain the fire/explosion occurred while the motor vehicle was in transport.)
  3. **Immersion** - A motor vehicle encounters the first harmful event by immersion into a liquid, not as a result of a **cataclysm**.
  4. **Jackknife** - A crash which results from unintended contact between any two units of the same multi-unit road vehicle; such as a truck-trailer combination.
  5. **Fell / Jumped From MV** - A person falls or jumps (not with suicidal or self-harming intentions) from the vehicle.
  6. **Cargo / Equip Loss / Shift** - Refers to the loss or shift of items carried on or in a motor vehicle or its trailing unit. The loss or shift would have to cause **damage** to the motor vehicle or **occupants** that is transporting the cargo/equipment or the cargo or equipment itself. If cargo/equipment is lost and strikes another vehicle that is a collision event. In regard to *Sequence of Events under Section 7*, as a non-collision event, a cargo/equipment loss or shift is not necessarily harmful. For example, the loss or release of the goods being transported from the cargo compartment of the truck, or the shifting of position of the load affecting its balance.
  7. **Other Non-Collision** - A crash involving a **motor vehicle in transport**, other than a collision or those circumstances listed above.

Includes, but is not limited to:

- a. When the first damaging event is the undercarriage of the vehicle striking the **roadway** over which the vehicle is traveling. This includes a vehicle striking a pavement blow-up.
- b. Driving off a cliff where **damage** is not the result of an overturn or a collision with a **fixed object**.

- c. An unbelted **occupant** hits his or her head on the roof of a vehicle and is injured, when the vehicle travels over a sharp dip in the road.
- d. Situations where an occupant is sickened or dies due to carbon monoxide fumes leaking from a motor vehicle in transport.
- e. An object is thrown or falls on a motor vehicle in transport. This includes objects that unintentionally strike a motor vehicle in transport such as a falling tree/rock, dropping/throwing something off of a bridge, being struck by a golf ball, etc.
- f. Breakage of any part of motor vehicle, resulting in **injury** or in further property **damage**.
- g. Toxic or corrosive chemicals leaking out of motor vehicle.
- h. **Injury** or **damage** involving only motor vehicle of non-collision nature, such as an overpass bridge giving way under the weight of a motor vehicle, without overturning or collision.
- i. Other **injury** or **damage** originating on or in motor vehicle.

Excludes:

- a. Events not associated with transport, such as a fight between **occupants**, occupant injured by a burning cigarette, firearm discharging in a motor vehicle, or similar events.
- b. Carbon monoxide poisoning in a motor vehicle not in transport.
- c. Breakage of any part, such as a fan belt or axle, with no additional **damage** or **injury**.
- d. **Injury** or **damage** resulting from working on motor vehicle not in transport.

iii. **COLLISION INVOLVING** - A crash involving a **motor vehicle in transport** in which the **first harmful event** occurs during a collision with one of the following:

1. **Animal** - This includes both live and dead animals. Indicate the type of animal under *Animal Codes* in *Section 8* and its disposition in *Section 9 - Narrative / Statements*.

An animal being used for transportation purposes is considered an "Animal Drawn Veh / Animal Ridden Trans."

A collision involving a wild animal, i.e., having no monetary value, where no other **damage** is sustained is not a motor vehicle crash. Conversely, a collision involving a domestic animal with monetary value would be a motor vehicle crash regardless of any other **damage** sustained.

2. **Pedalcycle** - A non-motorized device operated solely by pedals propelled by human power.

Includes (but is not limited to): Bicycle, tricycle, unicycle, pedalcar. Also includes a sidecar or trailer attached to any of these devices.

Excludes: These devices when towed by a motor vehicle including "hitching" (clinging to or being pulled by a motor vehicle).

Mark when cyclist was **in transport** at the time of the crash. A stopped pedalcycle is in transport if it is attended and in readiness for motion, such as stopped at a stop sign, traffic light, or waiting in traffic. The cyclist need not be occupying the riding saddle, but cannot be pushing the pedalcycle. A person pushing a pedalcycle is a **pedestrian**. A coasting pedalcycle with a rider is in transport.

3. **Fixed Object** - A fixed object is any object not in motion and attached to, or part of the terrain. Indicate the fixed object(s) struck under *Fixed Object Code(s)* in

Section 8. Describe **damaged** property, other than vehicles, in Section 3 - *Damage to Property Other Than Vehicles*.

Includes (but is not limited to):

- a. Any object attached to or a part of the terrain.
- b. Tree/stump (standing), embankment/**driveway**/ground/rock bluff, guardrail face, utility pole, fence, street light support, culvert, highway traffic sign post/support, bridge pier/abutment/support, curb, mailbox, concrete traffic barrier, building, traffic signal support, **impact attenuator/crash cushion**, fire hydrant, **bridge parapet** end, bridge rail, guardrail end, **median** / other traffic barrier, overhead sign support, ditch, other posts/poles/supports, wall, cable barrier, bridge overhead structure, or overhead line/cable. (Refer to **Section 8: Codes** on page 101 for a description of each of these objects).
- c. When the first damaging event is the undercarriage striking something OFF the **roadway** over which the vehicle was traveling.

**Note:** Crashes in which the first damaging event occurs when the vehicle overturns should be marked "Overturning" (above under "Non-collision") rather than "Fixed Object."

4. **Other Object** - An object which is moveable or moving and not fixed. Describe other objects struck in *Section 9 - Narrative / Statements* and list **damaged** property in *Section 3 - Damage to Property Other Than Vehicles*.

Includes (but is not limited to):

- a. Deceased person
- b. Objects dropped from motor vehicle or other vehicle, but not in motion
- c. Special devices not considered **in transport** or fixed objects
- d. Fallen tree or stone
- e. Landslide or avalanche materials not in motion
- f. Collision with a snow bank
- g. **Pedalcycle** not **in transport**
- h. Railway devices moved by human power
- i. Non-motorized devices not set in motion by **railway vehicle** such as a railway boxcar not set in motion by a railway vehicle
- j. Unattached trailer not set in motion by a motor vehicle
- k. Working equipment not meeting the definition of a **Working Motor Vehicle**
- l. Object set in motion by working equipment (not a Working Motor Vehicle)  
For example, a rock thrown into a **motor vehicle in transport** by a mower
- m. All other objects excluding those listed below
- n. **work zone** / maintenance equipment - Any object intentionally placed **for an official purpose** such as traffic barricades, road or construction machinery (not a **working motor vehicle** or motor vehicle in transport), construction materials, or similar objects placed on or along the **roadway** for the purposes of a work zone or for maintenance.

Excludes:

- a. Animal
- b. **Pedalcycle**
- c. **Fixed object**
- d. **Pedestrian**
- e. **Railway Vehicle**
- f. Animal drawn vehicle / animal ridden transportation
- g. **Motor Vehicle in Transport**

- h. [Parked motor vehicle](#)
- i. [Working motor vehicle](#)
- j. Objects set in motion by aircraft, watercraft, pedalcycle, [railway vehicle](#), animal drawn vehicle / animal ridden transportation, [motor vehicle in transport](#), or [working motor vehicle](#).
- k. Objects set in motion by [cataclysm](#).

5. **Pedestrian** - Any person who is not an [occupant](#), in or on, a vehicle.

**Note:** It is important to ascertain exactly where the person was located in relationship to their transition into or out of the vehicle. Once the unstabilized situation begins, a pedestrian remains a pedestrian until the crash stabilizes.

- If a person is on his/her feet outside the vehicle, he/she is considered a pedestrian.
- If a person is entering or exiting a vehicle, ensure he/she has successfully completed the transition from pedestrian to occupant or vice-versa.

Includes (but is not limited to):

- a. Person on foot
- b. Person walking, running, jogging, hiking, sitting, or lying within the [trafficway](#) or on private property, etc.
- c. Persons in buildings
- d. Person on [personal conveyance](#)
  - i. Rideable toys
    - 1. Roller skates, in-line skates
    - 2. Skateboard
    - 3. Toy car (Not motorized)
    - 4. Baby carriage
    - 5. Scooter (Not motorized)
    - 6. Toy wagon
  - ii. Motorized rideable toys
    - 1. Motorized skateboard
    - 2. Motorized toy car
  - iii. Devices for personal mobility assistance
    - 1. Segway-style device
    - 2. Motorized and non-motorized wheelchair
    - 3. Handicapped scooter
- e. A person ejected from a transport vehicle who has come to rest during a prior unstabilized situation and is not deceased; and is struck in a second or subsequent unstabilized situation.

Excludes:

- a. A person ejected from a transport vehicle during one unstabilized situation is still considered an occupant and not a pedestrian for the purposes of that unstabilized situation.
- b. A deceased person is considered an "Other Object." For example, a pedestrian is fatally struck, comes to rest on the [roadway](#), and the crash event stabilizes. The corpse is then struck by another vehicle. The corpse involved in the second crash is considered an "Other Object."

6. **Railway Vehicle** - Any device, with or without coupled cars, designed for transport on a railway. Includes any device designed to operate on railway tracks under its own power, such as a motor vehicle equipped with flange wheels. A non-motorized device, unattached from the power unit, or not set in motion by a power unit, is not a railway vehicle, e.g., boxcar sitting on rails not

attached to an engine is an "Other Object."

7. **Animal Drawn Veh / Animal Ridden Trans** - A vehicle or conveyance drawn by an animal for transportation purposes or an animal being ridden by a person(s) for transportation purposes.
8. **Motor Vehicle In Transport** - A motor vehicle being used for moving persons or property from one place to another, and is either in motion, in readiness for motion, or on a [roadway](#), but not parked in a designated area. Includes a motor vehicle moving, stopped, disabled, or abandoned on a roadway other than areas designated for parking. **Note:** Occupants ejected from a motor vehicle and hit (before stabilization) are still part of the vehicle.
9. **Parked Motor Vehicle** - A parked motor vehicle is a motor vehicle not in-transport, other than a [working motor vehicle](#), that is not in motion and not located on the [roadway](#) and is in a designated parking area or otherwise legally parked.

In roadway lanes used for travel during some periods and for parking during other periods, a parked motor vehicle should be considered to be in-transport during periods when parking is forbidden.

If a vehicle is stopped and legally parked, it is considered a parked motor vehicle and the vehicle is considered "off roadway." If a vehicle is stopped on a roadway, but not legally parked, it is considered a [motor vehicle in transport](#) and the vehicle is considered "on roadway." This is regardless of whether the vehicle is occupied or not.

Includes:

Any stopped motor vehicle where the entirety of the vehicle's primary outline as defined by the four sides of the vehicle (e.g., tires, bumpers, fenders) and load, if any, is not on the roadway.

Examples:

- i. A driver of a vehicle stopped curbside on a city street opens his door into the travel lane.
- ii. A truck stopped on the [shoulder](#) where only the extended side-view mirror overhangs the roadway edge line.
- iii. A motionless vehicle on the [shoulder](#), [median](#), or roadside.
- iv. A truck stopped at a gas station pump.
- v. A car parked in a metered parking lane, even when the meter time has expired.
- vi. A car stopped as far to the right as possible on a gravel road (i.e., legally parked), but with part of the car still on the traveled portion of the road.

Excludes:

- a. A motor vehicle in motion.
- b. A motor vehicle stopped and not legally parked.

- c. A motor vehicle left unattended on a **roadway**, where parking is always prohibited.

Examples:

- i. A vehicle driving down the road **shoulder**, **median**, or roadside.
- ii. A driverless vehicle without engine power starts in motion from a stopped position on the **shoulder**.
- iii. A stopped vehicle partially on the **shoulder** of an interstate highway with two tires on the roadway.
- iv. A tractor-trailer with part of its load extending over the roadway edge line.
- v. A vehicle left unattended in a lane during rush hour when parking is prohibited because it is in an open travel lane at the time.
- vi. A delivery service driver leaves his/her truck stopped at the curb of a street marked with "no parking at any time" signs while making a delivery.

10. **Working Motor Vehicle** - A motor vehicle in the act of performing construction, maintenance, or utility work related to the **trafficway**. This "work" may be located within open or closed portions of the trafficway and motor vehicles performing these activities can be within or outside of the trafficway boundaries. Working motor vehicles are not considered "in-transport."

Includes (but is not limited to):

- a. A vehicle at work in a marked **work zone**.
- b. A vehicle at work on the **median**, **shoulder**, or roadside.
- c. A mobile maintenance convoy.
- d. A law enforcement vehicle participating strictly in a stationary construction or mobile maintenance activity as a traffic slowing, control, signaling, or calming influence.

Examples:

- i. Asphalt roller working in a highway **work zone**.
- ii. State highway maintenance crew mowing grass on roadside.
- iii. Utility truck performing maintenance on the power lines along the roadway.
- iv. A private excavating company contracted by the state digging the foundation for a new overpass.

Excludes:

- a. A vehicle performing a private construction/maintenance activity not in association with the **trafficway**.
- b. A law enforcement vehicle performing other work activities, such as traffic stops, crash investigation, patrolling and traffic control not related



to construction, maintenance, or utility work on the [trafficway](#).

- c. A vehicle performing a work activity other than highway construction, maintenance or utility work.
- d. A construction, maintenance, utility vehicle while moving from one job site to another.
- e. A utility vehicle parked on the [trafficway](#) where no component of the vehicle is engaged in the work being performed.

Examples:

- i. An excavation company digging a foundation for a new building.
- ii. Garbage truck, delivery truck, taxi, emergency vehicle, tow truck, etc.

#### iv. DIRECTIONAL ANALYSIS FOR IMPACT WITH MOTOR VEHICLE

Identifies the manner in which two motor vehicles, either parked or in transport, or a [working motor vehicle](#), initially came together without regard to the direction of force. This refers only to crashes where the [first harmful event](#) involves a [motor vehicle in transport](#), [parked motor vehicle](#), or working motor vehicle.

(Source of Illustrations: MMUCC)

- 1. **Front to Front** - The front end of one vehicle collides with the front end of another vehicle.

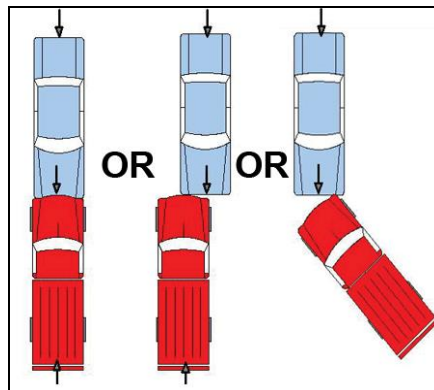

- 2. **Front to Rear** - The front end of one vehicle collides with the back of another vehicle or vice-versa (the rear of one vehicle collides with the front of another).

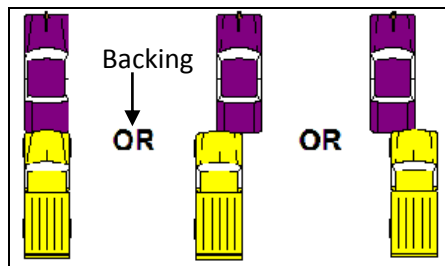

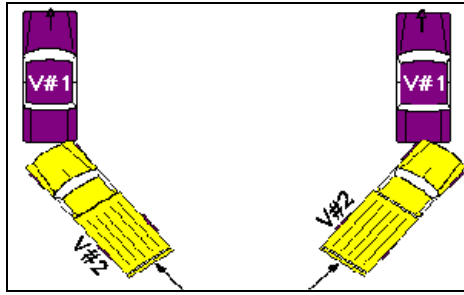

3. **Rear to Rear** - The rear of a vehicle makes contact with the rear of another. This can happen when two vehicles are backing up or when one vehicle backs into the rear of a parked vehicle.

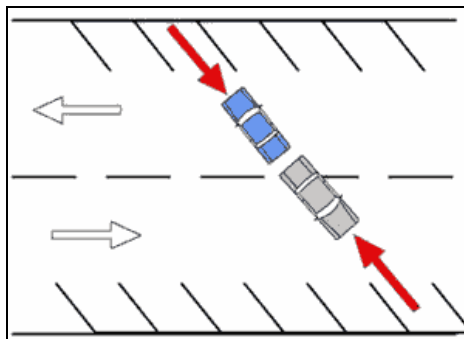
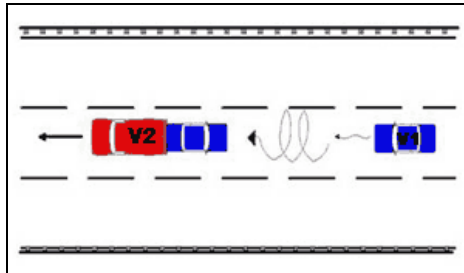

4. **Rear to Side** - The rear of a vehicle, not the front, makes contact with the side of another vehicle.

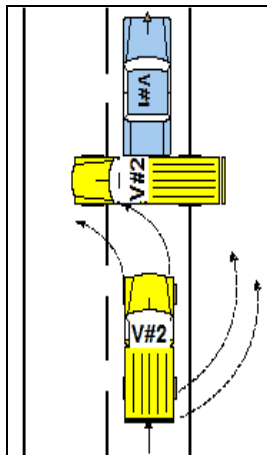

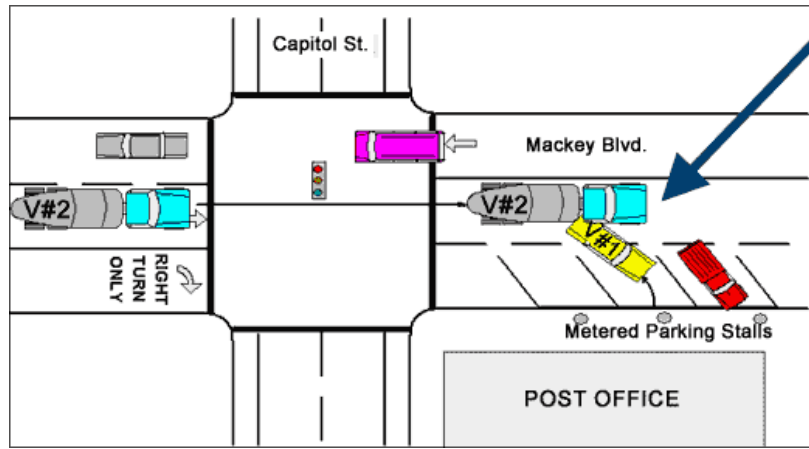

5. **Angle** - Two motor vehicles impact at an angle.

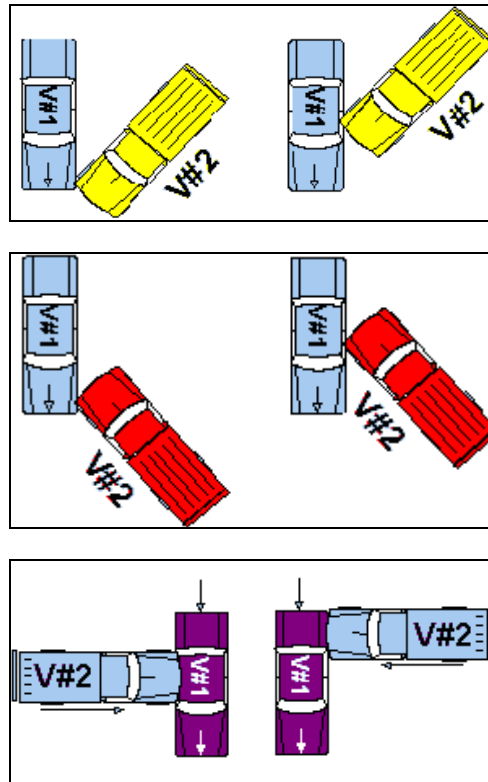

6. **Sideswipe (Same Dir.)** - Two vehicles traveling or facing in the same direction impact one another where the initial engagement does not overlap the corner of either vehicle so that there is not significant involvement of the front or rear surface areas. The impact then swipes along the surface of the vehicle parallel to the direction of travel.

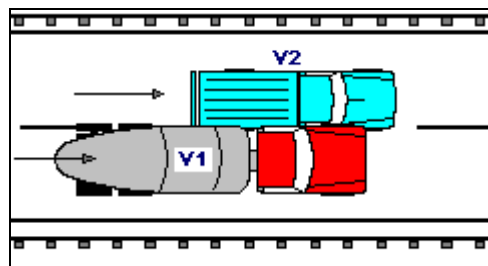

7. **Sideswipe (Opp. Dir.)** - Two vehicles traveling or facing in the opposite direction impact one another where the initial engagement does not overlap the corner of either vehicle so that there is no significant involvement of the front or rear surface areas. The impact then swipes along the surface of the vehicle parallel to the direction of travel.

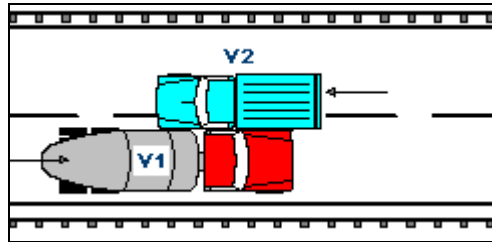

8. **Falling / Shifting Cargo (Set in Motion by MV)** - Cargo or other load on one [motor vehicle in transport](#) shifts and lands or is thrown onto/into another vehicle.
9. **Other (Explain)** - Used for any collision between two motor vehicles where the collision is not described by the other attributes above. Describe direction of collision in *Section 9: Narrative / Statements*.

Examples:

- a. When one vehicle is airborne and makes contact with its front to the other vehicle's hood or top.
  - b. A vehicle [occupant](#) or motorcyclist falls or is thrown from a vehicle striking or is struck by another vehicle.
10. **Unknown (Explain)** - Used when direction of collision is unknown. Explain why this is unknown in *Section 9: Narrative / Statements*.
- q. **COMMERCIAL MOTOR VEHICLE INVOLVEMENT CRITERIA** - Complete to identify whether the *Commercial Motor Vehicle* portion of *Section 7G: Commercial Motor Vehicle* must be completed.

i. **Does this crash involve any of the following?**

- 1a. A person fatally injured; OR
- 1b. A person transported for medical attention; OR
- 1c. A vehicle towed due to disabling damage.

**NO** - If none of these apply, mark "No" and do not continue to number 2 of the commercial motor vehicle involvement criteria and do not complete *Section 7G: Commercial Motor Vehicle*.

**YES** - If any of these apply, mark "Yes" and continue to number 2 of the Commercial Motor Vehicle Involvement Criteria.

ii. **Examine each vehicle to determine if it is a commercial vehicle based upon the following:**

2a. A truck / cargo van with Gross Vehicle Weight Rating (**GVWR**) or Gross Combined Vehicle Weight Rating (**GCVWR**) of more than 10,000 pounds; OR

2b. A motor vehicle with seating capacity of 9 or more including the driver; OR

2c. A vehicle displaying hazardous materials placard.

**NO** - If none of these were involved, mark "No" and do not complete *Section 7G: Commercial Motor Vehicle*.

**YES** - If any of these were involved, mark "Yes" and complete *Section 7G: Commercial Motor Vehicle*.

r. **EVIDENTIARY PHOTOS TAKEN** - Mark appropriate box to indicate whether photos were taken as part of the crash investigation, either by, or at the direction of, the investigator.

i. **By Whom** - Enter photographer's name.

ii. **Available From** - Mark the "Investigating Agency" box if the photos are available from the investigator's agency. If not, enter the department, division, or officer storing the photos.

s. **RECONSTRUCTION** - Mark the appropriate box to indicate whether the accident was reconstructed.

i. **By Whom** - Enter the reconstructionist's name.

ii. **Available From** - Mark the "Investigating Agency" box if the reconstruction report is available from the investigator's agency. If not, enter the department, division, or officer from whom the report is available.

## II. SECTION 2 - LOCATION

This section describes the location of the crash. Crashes should be located based on the following: If the first harmful ([damage](#) producing) event occurred on the [roadway](#), locate the crash to the roadway where the event occurred. If the vehicle left the roadway unintentionally before the [first harmful event](#), locate the crash to where the vehicle initially left the roadway (even if the vehicle returns to and the first harmful event occurs on the roadway). See examples in [Appendix E](#), page 136.

2 - LOCATION									
COUNTY		MUNICIPALITY		BEAT / ZONE		TRP/DIST/PCT		GPS COORDINATES (DD MM SS.S FORMAT)	
ON		RDWY. DIR.		DISTANCE FROM		LOCATION		INTERSECTING	
SPEED LIMIT		ROAD MAINTAINED BY		<input type="checkbox"/> NA Feet Miles		<input type="checkbox"/> After <input type="checkbox"/> Before <input type="checkbox"/> At		<input type="checkbox"/> NA SPEED LIMIT INT. DIR. GEO - CODE	
<input type="checkbox"/> State <input type="checkbox"/> County <input type="checkbox"/> Municipal <input type="checkbox"/> Private Property <input type="checkbox"/> Other									
TRAFFICWAY					ROAD ALIGNMENT				
<input type="checkbox"/> One-Way <input type="checkbox"/> Two-Way; Not Divided <input type="checkbox"/> Two-Way; Divided; Unprotected Median <input type="checkbox"/> Two-Way; Not Divided; Continuous Center Turn Lane <input type="checkbox"/> Two-Way; Divided; Positive Median Barrier <input type="checkbox"/> Other <input type="checkbox"/> Unknown (Explain)					<input type="checkbox"/> Straight <input type="checkbox"/> Curve <input type="checkbox"/> Unknown (Explain)				
<input type="checkbox"/> Level <input type="checkbox"/> Downhill <input type="checkbox"/> Dip <input type="checkbox"/> Uphill <input type="checkbox"/> Hillcrest <input type="checkbox"/> Unknown (Explain)									
INTERSECTION TYPE					ROAD CONDITION				
<input type="checkbox"/> NA <input type="checkbox"/> 4-way Intersection <input type="checkbox"/> Y-Intersection <input type="checkbox"/> 5-way / More <input type="checkbox"/> T-Intersection <input type="checkbox"/> Roundabout <input type="checkbox"/> Other (Explain)					<input type="checkbox"/> Dry <input type="checkbox"/> Wet <input type="checkbox"/> Snow <input type="checkbox"/> Ice / Frost <input type="checkbox"/> Slush <input type="checkbox"/> Mud / Dirt <input type="checkbox"/> Standing Water <input type="checkbox"/> Moving Water <input type="checkbox"/> Sand / Gravel <input type="checkbox"/> Other (Explain)				
ROAD SURFACE					WEATHER CONDITION				
<input type="checkbox"/> Concrete <input type="checkbox"/> Asphalt <input type="checkbox"/> Brick <input type="checkbox"/> Gravel <input type="checkbox"/> Dirt / Sand <input type="checkbox"/> Multi-Surface <input type="checkbox"/> Cobblestone <input type="checkbox"/> Unknown (Explain)					<input type="checkbox"/> Clear <input type="checkbox"/> Cloudy <input type="checkbox"/> Rain <input type="checkbox"/> Snow <input type="checkbox"/> Sleet / Hail <input type="checkbox"/> Freezing (Temp) <input type="checkbox"/> Fog / Mist <input type="checkbox"/> Severe Crosswind <input type="checkbox"/> Other (Explain)				
LIGHT CONDITION									
<input type="checkbox"/> Daylight <input type="checkbox"/> Dark-Lighted <input type="checkbox"/> Dark-Unlighted <input type="checkbox"/> Dark-Unknown Lighting <input type="checkbox"/> Other (Explain)									

- COUNTY** - Enter the name of the county in which the crash occurred. Exception: Crashes occurring in the City of St. Louis enter "St. Louis City."
- MUNICIPALITY** - Enter name of the incorporated city, town, or village in which the crash occurred. If the area is unincorporated, enter "NA."
- BEAT / ZONE** - Enter the appropriate number(s) or letter(s) to indicate the beat or zone in which the crash occurred. Enter "NA" if this field is not applicable.
- TRP / DIST / PCT** - Enter the appropriate number(s) or letter(s) to indicate the troop, district, or precinct in which the crash occurred. Enter "NA" if this field is not applicable.
- GPS COORDINATES** - Enter the appropriate location latitude and longitude coordinates using the DD MM SS.S (decimal seconds) format and WGS84 datum setting. The maximum latitude can be 40 degrees with the minimum being 35. The maximum longitude can be 95 degrees with the minimum being 89.
- ON** - Street, highway, or privately owned public [trafficway](#) on which the crash occurred.

Crashes should be located based on the following: If the [first harmful event](#) occurred on the [roadway](#), locate the crash to the roadway where the event occurred. If the vehicle left the roadway unintentionally before the first harmful event, locate the crash to where the vehicle initially left the roadway. See examples in [Appendix E](#), page 136.

Enter [route designation](#) (IS, US, MO, RT, CST, RP, etc.), then the number, letter, or full street name (70, 63, 13, A, Broadway AVE, etc.) of the road, street, or highway on which the crash occurred as listed in the [MoDOT Interactive Mapping Tool](#) (<https://168.166.124.8/TMSReports/mshp.do>). Example: IS 70, US 63, MO 13, RT A, CST Broadway AVE, RP 104221, etc. Bridge names / numbers, Emergency Reference Markers ([ERM](#)), and junction values cannot be shown in this field.

See examples for crashes occurring at weigh station (WS) or rest areas (RA) in [Appendix E](#), page 174. See an example for a crash occurring on a [reversible](#) (RV) roadway in [Appendix E](#), page 176.

**Note:** Crashes within interchanges are located to the roadway on which they occur, i.e., [ramps](#), overpasses, primary roadway, etc. Ramp numbers must be used when a crash occurs on a ramp. The numbers can be found on the MoDOT Location Book or the [MoDOT Interactive Mapping Tool](#). For example, a crash occurring on ramp number 6998, located on IS 70 eastbound at US 54, will be shown in this field as "RP 6998." See example in [Appendix E](#), page 156. Ramps can overlap other ramps. The method for locating crashes on overlapping ramps is explained in [Appendix E, Example #7 \(Diverging Diamond Interchanges\)](#), page 165 and [Example #8 \(Directional Interchanges\)](#), page 168.

When route names are not appropriate or there is no name, it is permissible to use "private lane," "private road," "alley," "city street (unnamed)," etc. However, there must be a route designation (PP, PVT, ALY, etc.) shown preceding the name. Roadways that are maintained by government agencies, but are not state, city, or county routes (i.e., roads on state university campuses, park roads, airport roads, etc.) should be assigned the PVT route designator.

See page 43 for [examples](#) of locating private property crashes.

The following standard abbreviations must be used in street names (rather than spelling out the entire word) **DO NOT use periods at the end of these abbreviations:**

Avenue	AVE
Boulevard	BLVD
Circle	CIR
Court	CT
Cutoff	CUTOFF (Not abbreviated)
Drive	DR
Expressway	EXPY
Highway	HWY
Lane	LN
Parkway	PKWY
Place	PL
Road	RD
Street	ST
Terrace	TER
Trafficway	TRFY

The exact address or block number (with the street name) of the crash may be indicated in this field; however, the route designation, along with the "Roadway Direction," "Distance From," "Location," and "Intersecting Street or Roadway" fields must be completed.

Example:

ON CST 4325 West 25th AVE		RDWY DIR S	DISTANCE FROM 150 <input type="checkbox"/> NA Feet	LOCATION <input checked="" type="checkbox"/> After <input type="checkbox"/> NA <input type="checkbox"/> Before <input type="checkbox"/> At	INTERSECTING CST College CIR
SPEED LIMIT 25	ROAD MAINTAINED BY <input type="checkbox"/> State <input type="checkbox"/> County <input checked="" type="checkbox"/> Municipal <input type="checkbox"/> Private Property <input type="checkbox"/> Other		_____ Miles		SPEED LIMIT INT. DIR GEO - CODE NA E NA

When entering roadway information, the following route designations must be used:

IS	Interstate	CO	Connector for Wye Leg
US	U.S. Highway	EOR	East Outer Road
MO	State Numbered	NOR	North Outer Road
RT	State Lettered	SOR	South Outer Road
AL	Alternate Route	WOR	West Outer Road
LP	Loop (Interstates Only)	PVT	Private Road
BU	Business Route (US or MO only)	RV	<a href="#">Reversible</a>
SP	Spur	RA	Rest Area
CST	City Street	WS	Weigh Station
RP	Ramp	ALY	Alley
CRD	County Road	BRIDGE	Bridge

PP	Private Property	ERM	Emergency Reference Marker
DOD	Department of Defense		

**Note:** "PP" (Private property) includes unnamed private roads, private property other than marked (or named) private roads and [parking lots](#). "PVT" (Private Road) is used for named private roads.

- g. **RDWY. DIR.** - (Roadway Direction) Enter the route direction (N, S, E, or W) in this field. Only "N", "S", "E", or "W" can be used. For instance, "NE" or "SW" cannot be used. If the [first harmful event](#) occurred off the [roadway](#), use the roadway direction of the lane where the vehicle initially left the roadway. If the first harmful event is on the roadway, use the roadway direction of the lane where the first harmful event occurred.

Enter "NA" for crashes occurring on private property (PP). (See [examples](#) on page 43).

The route direction is listed on the MoDOT Location Book or the [MoDOT Interactive Mapping Tool](#) along with associated intersecting routes. All even numbered routes are east / west, and all odd numbered routes are north / south; this includes circumferential routes such as IS 435, IS 270, etc. The lettered route direction, i.e., RT A, is determined by the overall direction of the route from beginning to end. The direction of travel can be determined by comparing intersections on the MoDOT Location Book or the [MoDOT Interactive Mapping Tool](#) with intersections on the route where the crash occurred.

**Note:** This is the overall roadway direction & not necessarily the compass direction the vehicles were traveling. If the compass direction of the vehicle differs from the overall direction of the roadway (for instance a vehicle proceeding northbound on an east / west roadway), note this information in the narrative.

- h. **DISTANCE FROM** - Enter the distance to the crash scene from the nearest intersecting street, roadway, [ramp](#), or bridge as listed on the MoDOT Location Book or the [MoDOT Interactive Mapping Tool](#). The distance from the crash scene to an Emergency Reference Marker ([ERM](#)) may also be used. Enter distances in feet or miles. If entered in miles, distances must be reported in tenths, i.e., 3.1. The distance must be measured to the nearest edge of the roadway, beginning of a bridge structure, or from an [ERM](#). When locating a crash on a ramp, measure to or from the painted gore (where the ramp leaves or joins a roadway) or to the nearest [roadway](#) when a gore is not present. If the distance cannot be determined, enter "Unk" in either the "Feet" or "Miles" fields. "Unk" cannot be entered if the crash was investigated at the scene.

**NA** - Mark if the crash is at the intersecting street, roadway, [ERM](#), or beginning of a bridge structure. If "NA" is selected, then "At" must be selected in the "Location" field (below). "NA" cannot be selected for private property (PP) crashes (i.e., parking lots, fields, yards, unmarked / unnamed private roads, etc.), but can be used for crashes occurring on a marked / named private road (PVT).

See page 43 for examples of locating [private property crashes](#).

See definition of "[intersection](#)" in glossary (page 14) and examples of measurements to intersections in [Appendix E](#), page 136.

- i. **LOCATION** - Indicate crash location from intersecting street, roadway, [ramp](#), or BEGINNING of bridge structure as listed on the MoDOT Location Book or the [MoDOT Interactive Mapping Tool](#), or Emergency Reference Marker ([ERM](#)), by marking "After" or "Before" the referenced [intersection](#), ramp, ERM, or bridge structure. Always use the roadway direction relating to the "On" field to determine "After" or "Before." See examples in [Appendix E](#), page 136.

**AFTER** - Mark if the crash occurred after an [intersection](#), [ERM](#), or beginning of bridge structure (entered in the "Intersecting" field). "After" is based on the roadway direction (entered in the "Rdwy Dir" field) of the lane in which the [first harmful event](#) occurred or the lane where the vehicle initially left the [roadway](#).



**BEFORE** - Mark if the crash occurred before an [intersection](#), [ERM](#), or beginning of bridge structure (entered in the "Intersecting" field). "Before" is based on the roadway direction (entered in the "Rdwy Dir" field) of the lane in which the [first harmful event](#) occurred or the lane where the vehicle initially left the [roadway](#).

**AT** - Mark if the crash occurred within the confines of the [intersection](#), or at an [ERM](#) or beginning of a bridge structure. If marked, then "NA" must be selected in the "Distance From" field (above).

**NA** - Mark if this information is unknown or the crash occurs on private property (PP), (i.e., [parking lots](#), fields, yards, unmarked / unnamed private roads, etc.) If selected for a crash on private property (PP), a valid number (feet or miles) must be entered in the "Distance From" field (above). See page 43 for examples of locating [private property crashes](#).

j. **INTERSECTING**

- i. Intersecting street, roadway, [ramp](#), bridge structure, or emergency reference marker ([ERM](#)).

The intersecting street name, roadway name, ramp number, or bridge structure number **MUST** match the name or number listed on the MoDOT Location Book or the [MoDOT Interactive Mapping Tool](#).

- **Intersecting roadways** - Enter route designation (IS, US, MO, RT, CST, RP, etc.), then the number, letter, or full street name (70, 63, 13, A, Broadway AVE, etc.) of the nearest intersecting road, street, highway, or ramp listed on the MoDOT Location Book or the [MoDOT Interactive Mapping Tool](#). Example: IS 70, US 63, MO 13, RT A, CST Broadway AVE, RP 104221, etc.

Intersecting roadways listed on the MoDOT Location Book or the [MoDOT Interactive Mapping Tool](#) will be used except when a crash occurs within an [intersection](#) where the intersecting roadway is not listed. In these cases, the crash must be shown as occurring at the unlisted roadway. The crash location to the nearest street, roadway, ramp, or bridge structure listed on the MoDOT Location Book or the [MoDOT Interactive Mapping Tool](#) must then be identified in *Section 9 - Narrative / Statements*. The "Distance From" and "Location" fields must be shown along with the route designator (US, MO, RT, RP, BRIDGE, etc.) and name of the street, roadway, bridge structure number, or ramp number. (See example in [Appendix E](#), page 136).

Crashes that occur on ramps listed on the MoDOT Location Book or the [MoDOT Interactive Mapping Tool](#) are referenced to the entrance or exit gore, or to the roadway intersecting with the ramp. (See example in [Appendix E](#), page 156).

When two roadways with the same name intersect more than once within a county, the following must be entered in parenthesis after the roadway name:

- If two or three intersections, use the appropriate letters from the MoDOT Location Book or the [MoDOT Interactive Mapping Tool](#): (NJ) - North Junction; (SJ) - South Junction; (EJ) - East Junction; (WJ) - West Junction; (MJ) - Middle Junction to indicate the junction being referenced. See diagram in [Appendix E](#), page 171.
- If four or more intersections, the MoDOT Location Book or the [MoDOT Interactive Mapping Tool](#) **MUST** be used to obtain the appropriate numerical value assigned to the specific junction. See diagram in [Appendix E](#), page 172.
- **Ramps** - [Ramps](#) may only be used in the "Intersecting" field if the crash did not occur on a ramp. Crashes occurring on a ramp must be measured to the nearest

intersecting roadway (other than a ramp) or bridge.

- **Bridge** - When using a bridge in the "Intersecting" field, the word "BRIDGE" and the bridge number are required (BRIDGE A2601). When locating crashes on or referenced to a bridge, the bridge number on the MoDOT Location Book or the [MoDOT Interactive Mapping Tool](#) identifies the beginning of the bridge structure in conjunction with the direction of the roadway. Therefore, crashes must be measured to the BEGINNING (not the middle or end) of a bridge structure as it relates to the roadway direction entered in the "Rdwy Dir" field. The bridge structure does not include any attached guardrail or crash barriers.

**Bridge names must not be used in locating the crash** (i.e., Poplar Street Bridge, Paseo Bridge, Missouri River Bridge, Mississippi River Bridge, etc.). If needed, the bridge name may be included in *Section 6 - Collision Diagram* and/or *Section 9 - Narrative / Statements*.



In cases where a crash occurs on a bridge connecting to another state, the state line in the lane entering Missouri must be used as the beginning of the bridge structure.

Example: If locating a crash to the eastbound lane of an east-west roadway, the crash would be referenced to the beginning of the bridge structure in the eastbound lane. See diagram in [Appendix E](#), page 173.

- **Emergency Reference Markers (ERM)** - ERMs are located statewide on most interstate highways, along with some US highways and other numbered routes. ERMs, which are normally spaced 0.2 miles apart, can be used to locate crashes. ERMs provide the direction of travel, interstate route, milepost, and tenth of a mile location. When used, crashes should be located to the nearest ERM, which should be 528 feet (0.1 mile) or less from the crash scene. Missing ERM locations must not be used. In these cases, the nearest ERM that is not missing or the nearest roadway or bridge as listed on the MoDOT Location Book or the [MoDOT Interactive Mapping Tool](#) must be used.

**Note:** The abbreviation "ERM" must be used as a route designation when using an emergency reference marker as the "Intersecting" street, etc. in *Section 2 - Location* of the crash report. Emergency reference markers cannot be used in the "On" field to locate crashes.

The exact information contained on the ERM must be shown in this field. Examples:



- A crash logged to the 10.0 ERM on the westbound lanes of IS 64 (above) will be shown as "ERM West IS 64 Mile 10.0".

ON IS 64		RDWY. DIR. W	DISTANCE FROM 100 <input type="checkbox"/> NA Feet _____ Miles	LOCATION <input type="checkbox"/> After <input type="checkbox"/> NA <input checked="" type="checkbox"/> Before <input type="checkbox"/> At	INTERSECTING ERM West IS 64 Mile 10.0
SPEED LIMIT 70	ROAD MAINTAINED BY <input checked="" type="checkbox"/> State <input type="checkbox"/> County <input type="checkbox"/> Municipal <input type="checkbox"/> Private Property <input type="checkbox"/> Other	<input type="checkbox"/> Unknown			SPEED LIMIT INT. DIR. GEO - CODE NA NA NA



- A crash logged to the 220.4 ERM on the westbound lanes of IS 70 (above) will be shown as "ERM West IS 70 Mile 220.4".

ON IS 70		RDWY. DIR. W	DISTANCE FROM 50 <input type="checkbox"/> NA Feet _____ Miles	LOCATION <input checked="" type="checkbox"/> After <input type="checkbox"/> NA <input type="checkbox"/> Before <input type="checkbox"/> At	INTERSECTING ERM West IS 70 Mile 220.4
SPEED LIMIT 70	ROAD MAINTAINED BY <input checked="" type="checkbox"/> State <input type="checkbox"/> County <input type="checkbox"/> Municipal <input type="checkbox"/> Private Property <input type="checkbox"/> Other	<input type="checkbox"/> Unknown			SPEED LIMIT INT. DIR. GEO - CODE NA NA NA

**Note:** Bridge numbers, ERMs, and junction values can only be used in the "Intersecting" field.

**Private Property Crashes** - Locate private property crashes by street address; if no address can be determined, use the most descriptive method possible. In those cases where the "Location" and "Roadway Direction" fields are inappropriate, mark or enter "NA."

Example #1: A crash occurs in a large parking lot at 2487 Williamsburg Blvd. in front of the Wal-Mart building entrance, 157 feet west of Williamsburg Blvd. Complete these fields in the following manner:

ON PP Parking Lot at 2487 Williamsburg BLVD		RDWY. DIR. NA	DISTANCE FROM 157	LOCATION <input type="checkbox"/> NA <input type="checkbox"/> After <input type="checkbox"/> Before <input type="checkbox"/> At	INTERSECTING West of CST Williamsburg BLVD
SPEED LIMIT NA	ROAD MAINTAINED BY <input type="checkbox"/> Unknown <input type="checkbox"/> State <input type="checkbox"/> County <input type="checkbox"/> Municipal <input checked="" type="checkbox"/> Private Property <input type="checkbox"/> Other		<input type="checkbox"/> NA Feet Miles	<input checked="" type="checkbox"/> NA	SPEED LIMIT NA
					INT. DIR. NA
					GEO - CODE NA

(See Example in [Appendix E](#), page 178)

Example #2: A crash occurs on an unnamed private road between two fescue fields 210 feet north of Route V and 1.2 miles west of Route F. There is no known address for the location. Complete these fields in the following manner:

ON PP Unnamed Private Road		RDWY. DIR. NA	DISTANCE FROM 210	LOCATION <input type="checkbox"/> NA <input type="checkbox"/> After <input type="checkbox"/> Before <input type="checkbox"/> At	INTERSECTING North of RT V. 1.2 miles West of RT F
SPEED LIMIT NA	ROAD MAINTAINED BY <input type="checkbox"/> Unknown <input type="checkbox"/> State <input type="checkbox"/> County <input type="checkbox"/> Municipal <input checked="" type="checkbox"/> Private Property <input type="checkbox"/> Other		<input type="checkbox"/> NA Feet Miles	<input checked="" type="checkbox"/> NA	SPEED LIMIT NA
					INT. DIR. NA
					GEO - CODE NA

(See Example in [Appendix E](#), page 178)

Example #3: A crash occurs on a privately maintained road, Jake's Lane. Jake's Lane is a north-south roadway and the crash occurred in the northbound lane, 300 feet south of Jones Circle. Jones Circle is an east-west roadway. Both roadways may or may not be found on the MoDOT Location Book or the [MoDOT Interactive Mapping Tool](#).

ON PVT Jake's LN		RDWY. DIR. N	DISTANCE FROM 300	LOCATION <input type="checkbox"/> NA <input checked="" type="checkbox"/> After <input type="checkbox"/> Before <input type="checkbox"/> At	INTERSECTING PVT Jones CIR
SPEED LIMIT NA	ROAD MAINTAINED BY <input type="checkbox"/> Unknown <input type="checkbox"/> State <input type="checkbox"/> County <input type="checkbox"/> Municipal <input checked="" type="checkbox"/> Private Property <input type="checkbox"/> Other		<input type="checkbox"/> NA Feet Miles	<input type="checkbox"/> NA	SPEED LIMIT NA
					INT. DIR. E
					GEO - CODE NA

(See Example in [Appendix E](#), page 178)

- k. **SPEED LIMIT** - ("On" Roadway Speed Limit) Enter the posted speed limit pertaining to the "On" roadway. Advisory speed signs (black and yellow in color) must not be used.

**Note:**

- The speed limit on a [ramp](#) is the same as that of the roadway the ramp is exiting. For example, a ramp exiting IS 70 to US 54 would have the same limit as IS 70 (70 mph). A ramp exiting US 54 to IS 70 would have the same limit as US 54 at that location (45 mph).

- l. **ROAD MAINTAINED BY** - Enter an "X" in the appropriate box indicating who maintains the roadway shown in the "On" field. Interstate and most U.S. highways, including their ramps, are state-maintained roads. Use "Other" for crashes on roadways maintained by the Corps of Engineers, National Forest Service, or any other federally owned property.
- Unknown** - Mark if it cannot be determined who maintains the roadway.
  - State** - Mark if an entity of Missouri state government maintains the roadway. This includes MoDOT along with any other state agency such as the Department of Natural Resources, Department of Conservation, etc.
  - County** - Mark if the county where the crash occurred maintains the roadway. This includes special road districts.
  - Municipal** - Mark if the municipality where the crash occurred maintains the roadway.
  - Private Property** - Mark if the road is maintained by a private entity.
  - Other** - Mark if the road is not private property and is not maintained by the state, county, or municipality. This includes roads maintained by a federal agency such as the Corps of Engineers and National Park Service. Explain in *Section 9 - Narrative / Statements*.
- m. **SPEED LIMIT** - (Intersecting Speed Limit) When a crash occurs within an [intersection](#), enter the posted speed limit pertaining to the intersecting street or roadway. Enter "NA" when the crash does not occur within an intersection.

**Note:**

- The speed limit on a [ramp](#) is the same as that of the roadway the ramp is exiting. For example, a ramp exiting IS 70 to US 54 would have the same limit as IS 70 (70 mph). A ramp exiting US 54 to IS 70 would have the same limit as US 54 at that location (45 mph).
- n. **INT. DIR.** - (Intersecting Direction) Enter the direction (N, S, E, or W) of the roadway lane entered in the "Intersecting" field to which the crash is being referenced. For example, if measuring to the northbound lane of a north-south roadway, enter "N". See examples in [Appendix E](#), page 136. Enter "NA" if the crash is referenced to an [ERM](#) or bridge and not to a roadway or if the on-street designator is PP. .
- o. **GEO CODE** - Enter appropriate crash location geo-code if required by agency.
- p. **TRAFFICWAY** - Mark to best describe [trafficway](#) configuration at crash location.
- i. **One-Way** - Roadway in which movement of motor vehicles is allowed only in one direction.
  - ii. **Two-Way; Not Divided; Continuous Center Turn Lane** - Roadway that has a continuous two-way left-turn lane in the center for left turns and one or more lanes in opposite directions for through traffic.



(Source: MoDOT)

- iii. **Two-Way; Not Divided** - Roadway that is not divided and in which movement of motor vehicles is allowed in opposite directions.



(Source: MoDOT)

- iv. **Two-Way; Divided; Unprotected Median** - Trafficway that has one roadway with one or more lanes in which traffic goes one direction and another roadway with traffic going in opposite direction, and in which the two roadways are divided by a [median](#) that is open and without any type of protective barrier.



- v. **Two-Way; Divided; Positive Median Barrier** - Trafficway that has one roadway with one or more lanes in which traffic goes one direction and another roadway with traffic going in opposite direction, and in which the two roadways are divided by a protective barrier.



**Cable Barrier**

(Source: MMUCC)



- vi. **Other** - Mark if the trafficway configuration is not described above and for private property crashes not on a trafficway. Describe in *Section 9 - Narrative / Statements*.
  - vii. **Unknown** - Mark if the trafficway configuration at the crash scene is unknown. Explain in *Section 9 - Narrative / Statements*. "Unknown" cannot be marked if the crash was investigated at the scene.
- q. **ROAD ALIGNMENT** - The alignment of the roadway at the crash location.
- i. **Straight** - Mark if the roadway alignment was straight.
  - ii. **Curve** - Mark if the roadway alignment was a curve.
  - iii. **Unknown (Explain)** - Mark if the roadway alignment is unknown. Explain in *Section 9: Narrative / Statements*. "Unknown" cannot be marked if the crash was investigated at the scene.
- Note:** In the case of a private property crash, choose the roadway alignment that best describes the crash location.
- r. **ROAD PROFILE** - The characteristics of the "On" roadway as related to the direction entered in the "Rdwy. Dir." field. Mark one box to indicate whether the road was:
- i. **Level** - Predominantly flat section of roadway. No inclination of the roadway.
  - ii. **Uphill** - Upward inclination of the roadway.

- iii. **Downhill** - Downward inclination of the roadway.
- iv. **Hillcrest** - The top section of a hill or bridge where the grade transitions from an upgrade to a downgrade.
- v. **Dip** - The bottom section of a hill or bridge where the grade transitions from a downgrade to an upgrade. Also known as a "sag."
- vi. **Unknown (Explain)** - Mark if the road profile is unknown and explain in *Section 9 - Narrative / Statements*. "Unknown" cannot be marked if the crash was investigated at the scene.

**Note:** In the case of a private property crash, choose the roadway profile that best describes the crash location.

- s. **INTERSECTION TYPE** - If the crash is located at an [intersection](#), as defined in the glossary (page 14), identify the intersection type. See examples in [Appendix E](#), page 145.
  - i. **NA** - Mark if "Location" field is shown as "After," "Before," or "NA." Also, mark if "Location" is "At" and the route designation for the "Intersecting" field is BRIDGE or [ERM](#). See examples in [Appendix E](#), page 136.
  - ii. **4-way Intersection** - Location where two roadways cross or connect.

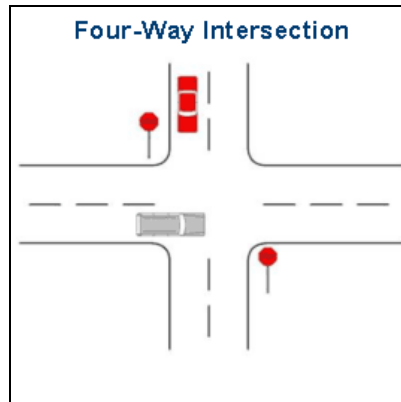

(Source: MMUCC)

- iii. **T-intersection** - Intersection where two roadways connect and one roadway does not continue across the other. The roadways form a "T."

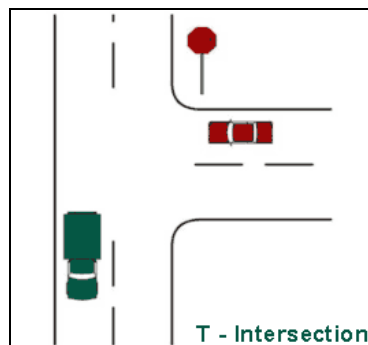

(Source: MMUCC)

- iv. **Y-intersection** - Intersection where three roadways connect and none of the roadways continue across the others. The roadways form a "Y".

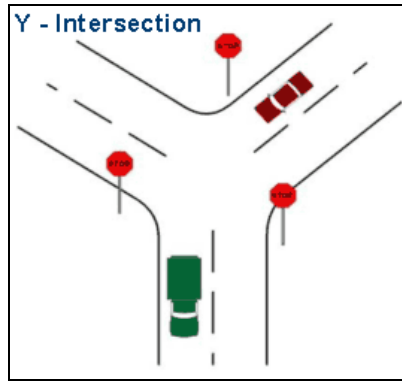

(Source: MMUCC)

- v. **Roundabout** - Circular traffic patterns in which traffic control is used on all entries, circulating vehicles have right of way. Circulation is counter-clockwise and passes to the right of the central island.

This also includes Traffic Circles, which is where vehicles must travel around a circle to continue on the same road or leave on any intersecting road.



(Roundabout)



(Traffic Circle)

- vi. **Five-way or More** - Location where more than two roadways cross or connect.



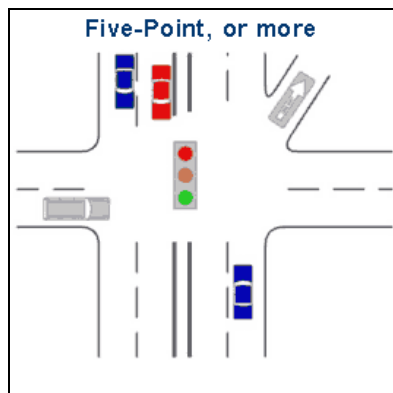

(Source: MMUCC)

- vii. **Other (Explain)** - Mark if the crash is located within an intersection not described above. Explain in *Section 9 - Narrative / Statements*.
  - viii. **Unknown (Explain)** - Mark "Unknown" and explain in *Section 9 - Narrative / Statements* if the information is not known. "Unknown" cannot be marked if the crash was investigated at the scene.
- t. **ROAD CONDITION** - The roadway surface condition at the time and place of the crash. Up to two selections can be made. Selections should be made without regard to whether or not the road surface conditions contributed to the cause of the crash.
- i. **Dry** - Roadway surface that is primarily dry.
  - ii. **Wet** - Roadway surface that is covered or partially covered with water.
  - iii. **Snow** - Roadway surface that is covered or partially covered with snow.
  - iv. **Ice / Frost** - Roadway surface that is covered or partially covered with ice or frost.
  - v. **Slush** - Roadway surface that is covered or partially covered with melting snow or ice.
  - vi. **Mud / Dirt** - Roadway surface covered or partially covered with mud or dirt. Indicates the substance's presence on the surface of the roadway at the crash location, not the surface type of the roadway.
  - vii. **Standing Water** - Roadway surface that is covered with an excessive amount of water that is not moving.
  - viii. **Moving Water** - Roadway surface that is covered with an excessive amount of water that is moving. Usually attributed to flooding and typically localized.
  - ix. **Sand / Gravel** - Roadway surface covered or partially covered with sand and/or gravel. Includes, but is not limited to, sand on the roadway as a result of being blown by the wind, or sand / gravel discharged or thrown on the roadway by vehicles. This indicates the substance's presence on the surface of the roadway at the crash location, not the surface type of the roadway.
  - x. **Other (Explain)** - This would include, but is not limited to, oil, grain, wet leaves, and liquids not listed above. Explain in *Section 9 - Narrative / Statements*.
  - xi. **Unknown (Explain)** - The road condition is unknown. Explain in *Section 9 - Narrative / Statements*.

- u. **ROAD SURFACE** - Indicates the primary surface of roadway at the crash location. Only one selection can be made.
  - i. **Concrete** - A roadway constructed of concrete for the surface. A concrete road with dirt, sand, or gravel washed on it is still a concrete road.
  - ii. **Asphalt** - A roadway constructed of bituminous material for the surface. An asphalt road with dirt, sand, or gravel washed on it is still an asphalt road.
  - iii. **Brick** - A roadway constructed using bricks for the surface. A brick road with dirt, sand, or gravel washed on it is still a brick road.
  - iv. **Gravel** - A roadway with a gravel surface.
  - v. **Dirt / Sand** - A roadway with a dirt or sand surface.
  - vi. **Multi-Surface** - Includes roadways with more than one type of surface. Explain in *Section 9 - Narrative / Statements*.
  - vii. **Cobblestone** - A roadway constructed of cobblestone for the surface. A cobblestone road with dirt, sand, or gravel washed on it is still a cobblestone road.
  - viii. **Unknown (Explain)** - The road surface is unknown. Explain in *Section 9 - Narrative / Statements*. "Unknown" cannot be marked if the crash was investigated at the scene.
  
- v. **WEATHER CONDITION** - The prevailing weather condition(s) that existed at the time of the crash. Up to three selections can be made. Selections should be made without regard to whether or not the weather conditions contributed to the cause of the crash.
  - i. **Clear** - Includes partial cloudiness if sunlight is not diminished.
  - ii. **Cloudy** - Usually "overcast" but may include partial cloudiness if light is diminished.
  - iii. **Rain** - Applies when precipitation is falling as rain at the time of the crash.
  - iv. **Snow** - Applies when precipitation is falling as snow at the time of the crash.
  - v. **Sleet / Hail** - Applies when precipitation is falling as ice (sleet/hail).
  - vi. **Freezing (Temp)** - The outside temperature at the time of the crash was freezing (32 degrees Fahrenheit / 0 degrees Celsius or below).
  - vii. **Fog / Mist** - Fog and mist are primarily water in the form of fine particles suspended or falling in the air. Applies when there is fog and/or mist at the scene at the time of the crash.
  - viii. **Severe Crosswind** - Refers to winds traveling at an angle with respect to the travel lanes at velocities significant enough to create a risk that vehicles could be diverted from their path or high profile vehicles could be blown over. These are winds that are strong enough to affect vehicle stability. **Note:** Includes only those winds not considered a [cataclysmic event](#).
  - ix. **Other (Explain)**- Includes, but is not limited to, blowing snow, sand, soil, or dirt, or any other weather condition not listed above. Explain in *Section 9 - Narrative / Statements*.
  - x. **Unknown (Explain)** - The weather condition at the time of the crash is unknown. Explain in *Section 9 - Narrative / Statements*.

- w. **LIGHT CONDITION** - The type/level of light that existed at the time of the crash. Only one can be selected.
- i. **Daylight** - "Natural" light exists. Daylight is considered to be 30 minutes before sunrise to 30 minutes after sunset.
  - ii. **Dark-Lighted** - No "natural" light exists but there is overhead "man-made" lighting on the roadway where the crash occurred. This does not include lighting from store fronts, houses, [parking lots](#), etc.
  - iii. **Dark-Unlighted** - No "natural" light exists and no overhead "man-made" lighting is present on the roadway where the crash occurred.
  - iv. **Dark-Unknown Lighting** - No "natural" light exists and the investigator is unable to determine if "man-made" lighting was present at the time of the crash.
  - v. **Other (Explain)** - Includes any condition other than the conditions listed above. Explain in *Section 9 - Narrative / Statements*. Mark if darkness is caused by an eclipse of the sun or other natural phenomenon.
  - vi. **Unknown (Explain)** - The light condition at the time of the crash is unknown. Explain in *Section 9 - Narrative / Statements*.

### III. SECTION 3 - DAMAGE TO PROPERTY OTHER THAN VEHICLES

List all damaged property not qualifying for entry in *Section 7 - Drivers, Vehicles, Owners, & Occupants*. The object and ownership are more important than the amount of **damage**. Show injury to domestic animals that have monetary value, or **damage** to trees, shrubs, property of determinable value, and government property such as highway signs, guard rails, lamp poles, etc.

3 - DAMAGE TO PROPERTY OTHER THAN VEHICLES		<input type="checkbox"/> None
LIST OWNER'S NAME & ADDRESS, DESCRIPTION OF PROPERTY, AND DAMAGE. <input type="checkbox"/> MoDOT <input type="checkbox"/> County <input type="checkbox"/> Municipality		

- a. **NONE** - Mark if there is no **damage** to property other than what is shown in *Section 7 - Drivers, Vehicles, Owners, & Occupants*.
- b. **MODOT** - Mark and list description and **damage** sustained if the property is owned by the Missouri Department of Transportation. MoDOT's address is not necessary.
- c. **COUNTY** - Mark and list description and **damage** sustained if the property is owned by the county in which the crash occurred. The county's address is not necessary.
- d. **MUNICIPALITY** - Mark and list description and **damage** sustained if the property is owned by the municipality in which the crash occurred. The municipality's address is not necessary.
- e. **OWNER'S NAME AND ADDRESS** - Enter owner's name and address (street, city, state, zip). This is not necessary if "MoDOT" is marked and there is no other personal property damaged. The name, but not the address, is required when "County" or "Municipality" is marked.
- f. **DESCRIPTION OF PROPERTY** - Describe property damaged as a result of the crash.
- g. **DAMAGE** - Enter the nature of the property **damage** (i.e., utility pole broken, 8 feet of guardrail damaged, 10 feet of fence and two fence posts damaged, etc.).

### IV. SECTION 4 - WITNESS

Complete this section with information pertaining to persons who witnessed the crash.

4 - WITNESS			<input type="checkbox"/> None Identified	<input type="checkbox"/> Additional Witnesses In Narrative
NAME	ADDRESS (Street, City, State, Zip)	PHONE NUMBER		

- a. **NONE IDENTIFIED** - Mark if no witnesses are identified.
- b. **ADDITIONAL WITNESSES IN NARRATIVE** - Mark and list additional witnesses in *Section 9 - Narrative / Statements* if there are more witnesses than space provided.
- c. **NAME** - Enter the current legal name of witness. Begin with either the first or last name.
- d. **ADDRESS** - Enter the witness's current address (street, city, state, and zip).
- e. **PHONE** - Enter the witness's telephone number, including the area code.

V. **SECTION 5 - PEDESTRIAN**

Complete this section with information pertaining to pedestrian(s) involved in the crash. Use the *Pedestrian / Occupant Continuation / Supplement* if more than one pedestrian is involved.

**Note:** It is important to ascertain exactly where the person was located in relationship to their transition into or out of the vehicle. Once the unstabilized situation begins, a pedestrian remains a pedestrian until the crash stabilizes.

- If a person is on his/her feet outside the vehicle, he/she is considered a pedestrian.
- If a person is entering or exiting a vehicle, ensure he/she has successfully completed the transition from pedestrian to **occupant** or vice-versa.

Examples of Pedestrian:

- A driverless vehicle begins to roll down a **driveway**. A person outside the vehicle tries to enter the driver's door but falls out before getting into the driver's seat.
- A pedestrian grabs onto the door handle to enter a stopped vehicle. In an attempt to flee, the driver accelerates the vehicle dragging the pedestrian 300 feet.
- A **school bus** is dropping off children. A child steps off the bus and her coat gets caught in the bus door when it closes. The bus begins to pull away and drags the child, causing fatal injury.

<b>5 - PEDESTRIAN</b> <input type="checkbox"/> NA <input type="checkbox"/> Law Enforcement Officer <input type="checkbox"/> Other Emergency Services Personnel <input type="checkbox"/> MoDOT Worker <input type="checkbox"/> Other Trafficway Worker <input type="checkbox"/> Other Pedestrian									
NO. NAME (Last, First, MI) & ADDRESS (Street, City, State, Zip)								PHONE NUMBER	
DATE OF BIRTH	SEX	STRUCK BY VEH #:	INJ	TRANS-PORT	SAFETY DEVICES	LOCATION <input type="checkbox"/> On Roadway <input type="checkbox"/> In Driveway Access <input type="checkbox"/> On Median / Crossing Island <input type="checkbox"/> On Sidewalk <input type="checkbox"/> Off Roadway <input type="checkbox"/> Unknown			
CROSSING ROAD <input type="checkbox"/> NA <input type="checkbox"/> With Signal <input type="checkbox"/> Not At Crosswalk <input type="checkbox"/> Against Signal <input type="checkbox"/> In Marked Crosswalk <input type="checkbox"/> No Signal <input type="checkbox"/> In Unmarked Crosswalk <input type="checkbox"/> Unknown <input type="checkbox"/> Unknown		OTHER ACTIONS <input type="checkbox"/> NA / None <input type="checkbox"/> Getting On / Off Vehicle <input type="checkbox"/> Working In Trafficway <input type="checkbox"/> Unknown <input type="checkbox"/> Standing / Lying / Sitting In Trafficway <input type="checkbox"/> Playing In Trafficway <input type="checkbox"/> Other (Explain) <input type="checkbox"/> Pushing / Working On Vehicle <input type="checkbox"/> Walking / Running In Trafficway <input type="checkbox"/> Behind / In Front of Parked / Stopped Veh. <input type="checkbox"/> With Traffic <input type="checkbox"/> Against Traffic				SCHOOL INFO <input type="checkbox"/> NA <input type="checkbox"/> Going To / From School <input type="checkbox"/> Getting On / Off School Bus <input type="checkbox"/> Both Of The Above <input type="checkbox"/> Unknown (Explain)			
PROBABLE CONTRIBUTING CIRCUMSTANCES <input type="checkbox"/> None <input type="checkbox"/> Failed To Yield <input type="checkbox"/> Alcohol <input type="checkbox"/> Vision Obstructed (Explain) <input type="checkbox"/> Other (Explain) <input type="checkbox"/> Distracted / Inattentive <input type="checkbox"/> Drugs <input type="checkbox"/> Physical Impairment (Explain) <input type="checkbox"/> Unknown (Explain)					DISTRACTED / INATTENTIVE CODE(S) <input type="checkbox"/> NA			ALCOHOL USE <input type="checkbox"/> Yes <input type="checkbox"/> No <input type="checkbox"/> Unknown	

- NA** - Mark if no pedestrian is involved in the crash.
- LAW ENFORCEMENT OFFICER** - Mark if a sworn on-duty law enforcement officer acting in an official capacity is the listed pedestrian involved in the crash. This does not include civilian or off-duty law enforcement personnel.
- OTHER EMERGENCY SERVICES PERSONNEL** - Mark if any emergency services personnel (other than a law enforcement officer) acting in an official capacity is the listed pedestrian involved in the crash. This includes fire personnel (full-time or volunteer), EMS personnel, or tow truck operators.
- MODOT WORKER** - Mark if any on-duty Missouri Department of Transportation worker acting in an official capacity is the listed pedestrian involved in the crash.
- OTHER TRAFFICWAY WORKER** - Mark if any other on-duty trafficway worker acting in an official capacity is the listed pedestrian involved in the crash. This includes county and municipality highway workers along with contract highway workers. Workers not associated with repairs, construction, or maintenance to the **trafficway** are excluded, i.e., utility workers, adopt-a-highway volunteers, etc.
- OTHER PEDESTRIAN** - Mark if the pedestrian was not a law enforcement officer, other emergency services personnel, MoDOT worker, or other trafficway worker.

- g. **NO.** - (Number) The unique number assigned to the pedestrian.
- h. **NAME (LAST, FIRST, MI)** - Enter the pedestrian's name. Enter individual's current legal name using last name, first name, and middle initial format. **Note:** Do not enter a period after an initial.  
Enter "Unknown" if the name cannot be determined.
- i. **ADDRESS (STREET, CITY, STATE, ZIP)** - Enter the pedestrian's address.
- j. **PHONE NUMBER** - Enter the pedestrian's telephone number, including the area code.
- k. **DATE OF BIRTH** - Enter the pedestrian's date-of-birth in the month, day, and year (mm-dd-yyyy) format. Enter "Unk" if unknown.
- l. **SEX** - Enter "M" for Male, "F" for Female, or "U" if the information is unknown.
- m. **STRUCK BY VEH #:** - Enter the unique number assigned to the first motor vehicle that struck the pedestrian. If one person is pushed into another person, identify the vehicle that struck the first person for both pedestrians.
- n. **INJ - (Injury)** Enter one code to indicate the pedestrian's injury severity. Use the codes listed in *Section 8 - Codes*. For a description of the codes, refer to *Section 8 - Codes* in this manual (page 93).  
**Note:** Injuries should be classified on the basis of conditions at the scene of the crash. The exception to this rule applies to fatal injuries (*late death*). Injuries that do not meet these criteria may be documented in *Section 9 - Narrative / Statements*.  
Enter "5" (None Apparent) for pedestrians who are not injured, but transported from the scene to a medical facility for precautionary measures. Explain in *Section 9 - Narrative / Statements*.
- o. **TRANSPORT** - Enter one code to indicate whether and how the pedestrian was transported from the scene to a medical facility for treatment of crash-related injuries. Use the codes listed in *Section 8 - Codes*. For a description of the codes, refer to *Section 8 - Codes* in this manual (page 94).  
List the name of the transporting agency or person, and medical facility they were transported to in *Section 9 - Narrative and Statements* if applicable.  
**Note:** Enter "1" (No) for pedestrians who are not injured, but transported from the scene to a medical facility for precautionary measures. In addition, mark "No" if a person deceased at the scene is transported. In either case, explain in *Section 9 - Narrative / Statements*.
- p. **SAFETY DEVICES** - Enter one or two codes to indicate the type of *safety device* used, if any, by the pedestrian. If only one safety device is applicable, then leave the second safety device field blank. Use the codes listed in *Section 8 - Codes*. For a description of the codes, refer to *Section 8 - Codes* in this manual (page 97). Enter "2" if no safety device was used. Safety codes 2, 7, 8, 13-15 and U are applicable for pedestrian use.
- q. **LOCATION** - The location of the pedestrian with respect to the roadway at the time he or she was struck. Only one option can be selected.
  - i. **On Roadway** - The pedestrian was on the roadway when struck. This includes a pedestrian in a crosswalk.
  - ii. **On Sidewalk** - The pedestrian was on a sidewalk when struck. This does not include a pedestrian in a crosswalk.
  - iii. **In Driveway Access** - The pedestrian was in the access to a *driveway* when struck.

A driveway access is a portion of the **trafficway** at the end of a **driveway** providing access to property adjacent to a trafficway. This includes entrances to private residences, entrances to a gas station, and sidewalks which cross over a driveway access. It excludes any area not within a trafficway.

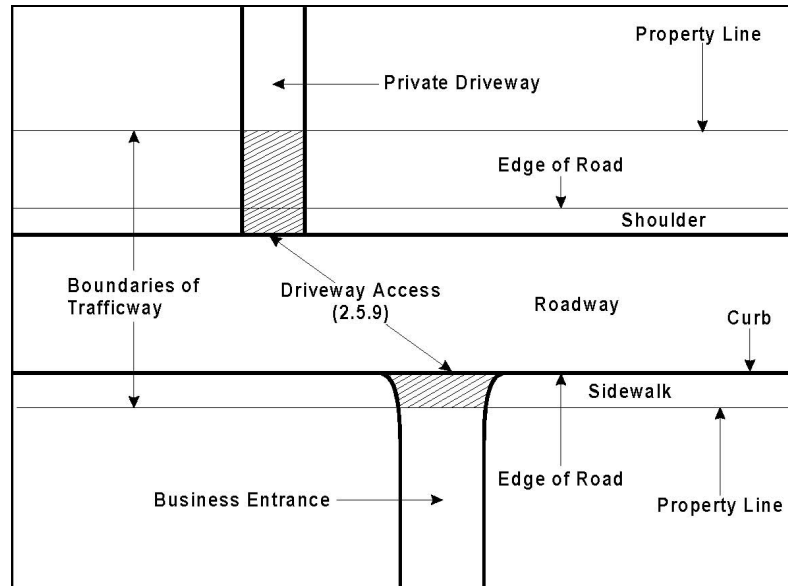

(Source: ANSI D16.1-2007 Manual on Classification of Motor Vehicle Traffic Accidents, 7th Edition)

- iv. **Off Roadway** - The pedestrian was not on the roadway, sidewalk, **median / crossing island**, or in a **driveway** access when struck. A person on the **shoulder** would be considered "Off Roadway."
- v. **On Median / Crossing Island** - The pedestrian was either in a **median** or on a **crossing island** when struck.

A **median** is an area of **trafficway** between parallel roads separating travel in opposite directions. Flush or painted medians should be 4 or more feet wide between inside roadway edge lines. Medians less than 4 feet wide shall have a barrier to be considered a median. Continuous left turn lanes are not considered painted medians.

A crossing island is a concrete or grassy area in the **trafficway** that is used by pedestrians when crossing the roadway.

- vi. **Unknown** - Mark if the location of the pedestrian when he or she is struck is unknown. Explain in *Section 9 - Narrative / Statements*.
- r. **CROSSING ROAD** - Indicates signal and crosswalk information in regard to the pedestrian crossing the road (if applicable). Up to two selections can be made.
  - i. **NA** - Mark if the pedestrian was not crossing the road when he or she was struck.
  - ii. **Signal**
    1. **With Signal** - Mark if a traffic signal was present and the pedestrian was crossing with a walk light or other signal indicating crossing was permissible when he or she was struck.
    2. **Against Signal** - Mark if a traffic signal was present and the pedestrian was crossing with a do not walk light or other signal indicating crossing was not permissible when he or she was struck.

3. **No Signal** - Mark if no pedestrian or other signal designed to indicate when crossing is permissible was present. Examples include, but are not limited to, intersections with only stop signs or flashing lights.
4. **Unknown** - Mark if the signal status at the time of the crash is unknown. Explain in *Section 9 - Narrative / Statements*.

iii. **Crosswalk**

1. **Not At Crosswalk** - Mark if the pedestrian was crossing the road at a location other than an [intersection](#) or in a designated crosswalk.
2. **In Marked Crosswalk** - Mark if the pedestrian was crossing a roadway within a marked crosswalk.
3. **In Unmarked Crosswalk** - Mark if the pedestrian was crossing at an [intersection](#) in an unmarked crosswalk. An unmarked crosswalk is an area that contains a crossing or connection of two or more roadways not classified as a [driveway access](#) but without distinct markings for pedestrian crossing indicated by lines or other markings on the surface of the roadway.
4. **Unknown** - Mark if it is unknown if the pedestrian was in a crosswalk. Explain in *Section 9 - Narrative / Statements*.

- s. **OTHER ACTIONS** - Other pedestrian actions at the time of the crash. Up to three selections can be made.

- i. **NA/None** - Mark if this section is not applicable to the crash.
- ii. **Getting On / Off Vehicle** - Mark if the person was getting into or out of a vehicle, or getting on or off a vehicle.

**Note:** It is important to ascertain exactly where the person was located in relationship to their transition into or out of the vehicle. Once the unstabilized situation begins, a pedestrian remains a pedestrian until the crash stabilizes. See [examples](#) on page 53

- If a person is on his/her feet outside the vehicle, he/she is considered a pedestrian.
- If a person is entering or exiting a vehicle, ensure he/she has successfully completed the transition from pedestrian to [occupant](#) or vice-versa.

- iii. **Standing / Lying / Sitting in Trafficway** - Mark if the pedestrian was standing, lying, or sitting in the [trafficway](#) when struck.
- iv. **Pushing / Working On Vehicle** - Mark if the pedestrian was pushing or working on a vehicle when struck.
- v. **Behind / In Front of Parked / Stopped Vehicle** - Mark if the pedestrian was behind or in front of a stopped or parked vehicle when struck. Includes instances where pedestrian steps from behind or in front of a parked or stopped vehicle.
- vi. **Working In Trafficway** - Mark if the pedestrian was working in the [trafficway](#) when struck. This includes, but is not limited to, trafficway workers.
- vii. **Playing In Trafficway** - Mark if the pedestrian was playing in the [trafficway](#) when struck.
- viii. **Walking / Running In Trafficway** - Mark if the pedestrian was walking or running in the [trafficway](#) when struck. Note: If **Walking / Running In Trafficway** is chosen, either **With Traffic** or **Against Traffic** must also be selected- see below.



- **With traffic-** Mark if the pedestrian was moving with the traffic flow when struck. (Must be selected in conjunction with Walking/Running in Trafficway.)
    - **Against Traffic-** Mark if the pedestrian was moving against the traffic flow when struck. (Must be selected in conjunction with Walking/Running in Trafficway.)
  - ix. **Unknown** - Mark if the actions of the pedestrian when he or she was struck are unknown. Explain in *Section 9 - Narrative / Statements*.
  - x. **Other (Explain)** - Explain in *Section 9 - Narrative / Statements*.
- t. **SCHOOL INFO.** - Information concerning K-12 students going to/from school or a school-sponsored event. Activities conducted on school property that are not school sponsored are excluded. For example, school property rented for antique shows, etc. Only one can be marked.
  - i. **NA** - Mark if this section does not apply.
  - ii. **Going To / From School** - Mark if the pedestrian was a K-12 student going to or from school or a school-sponsored event.
  - iii. **Getting On / Off School Bus** - Mark if the pedestrian was a K-12 student getting on or off a [school bus](#) associated with a school or a school-sponsored event.
  - iv. **Both of the Above** - Mark if the pedestrian is both going to or from school AND getting on or off a [school bus](#).
  - v. **Unknown (Explain)** - Mark if this information is unknown and explain in *Section 9 - Narrative / Statements*.
- u. **PROBABLE CONTRIBUTING CIRCUMSTANCES** - This section is used to record contributing circumstances to the crash on the part of the pedestrian. Mark all that apply. If "None," or "Unknown" are marked, then no other circumstances may be marked.
  - i. **None** - Mark only if, in the investigating officer's opinion, the pedestrian did not contribute to the crash.
  - ii. **Failed to Yield** - Mark if the pedestrian failed to yield as required.
  - iii. **Distracted / Inattentive** - Mark if the pedestrian was distracted or inattentive. A "Distraction / Inattention Code(s)" must be entered when this is marked. Use the codes listed in *Section 8 - Codes*. For a description of the codes, refer to [Section 8 - Codes](#) in this manual (page 107).
  - iv. **Alcohol** - Mark if the use of alcohol by the pedestrian contributed to the crash. This does not indicate intoxication only that alcohol consumption contributed to the crash. "Yes" under the "Alcohol Use" field must be selected if "Alcohol" is marked as a contributing circumstance.
  - v. **Drugs** - Mark if the use of drugs (legal or illegal) by the pedestrian contributed to the crash. This does not indicate intoxication only that drug use contributed to the crash.
  - vi. **Vision Obstructed (Explain)** - Mark if the pedestrian's vision was obscured and this contributed to the crash. Explain in *Section 9 - Narrative / Statements*.
  - vii. **Physical Impairment (Explain)** - Mark if a physical impairment on the part of the pedestrian contributed to the crash. Includes fatigue, asleep, and illness. Wearing glasses is not considered impairment. Explain in *Section 9 - Narrative / Statements*.
  - viii. **Other (Explain)** - Mark if another unlisted factor on the part of the pedestrian contributed to the crash. Explain in *Section 9 - Narrative / Statements*.

- ix. **Unknown (Explain)** - Mark if it is unknown whether actions on the part of the pedestrian contributed to the crash. Explain in *Section 9 - Narrative / Statements*.
- v. **DISTRACTED / INATTENTIVE CODE(S)** - List up to four distracted / inattentive codes if "Distracted / Inattentive" is marked in the "Probable Contributing Circumstances" field for the pedestrian.

Use the codes listed in *Section 8 - Codes*. For a description of the codes, refer to [Section 8 - Codes](#) in this manual (page 107). In addition, explain the cause of the distraction or inattention in *Section 9 - Narrative / Statements*.

**NA** - Mark if "Distracted / Inattentive" was not selected in the "Probable Contributing Circumstances" field for the pedestrian.

- w. **ALCOHOL USE** - This is reflective of the investigating officer's opinion as to the use of alcohol by the pedestrian and is not a judgment of quantity or intoxication.

**Note:** If, in the officer's opinion, alcohol use by the pedestrian contributed to the crash, it must be reflected in the "Probable Contributing Circumstances" field for the pedestrian.

- i. **Yes** - Use of alcohol on the part of the pedestrian is suspected. This must be selected if "Alcohol" is marked under the field "Probable Contributing Circumstances" for the pedestrian.
- ii. **No** - Use of alcohol on the part of the pedestrian is not suspected.
- iii. **Unknown** - Alcohol use on the part of the pedestrian is unknown.

VI. **SECTION 6 - COLLISION DIAGRAM**

This section contains the collision diagram and fields for showing direction of travel of each vehicle prior to the crash event.

REPORT # \_\_\_\_\_ PAGE \_\_\_\_\_ OF \_\_\_\_\_

6. COLLISION DIAGRAM	Compass Direction Before Crash Event(s) (Circle One)	V1 N E S W U	V2 N E S W U	V3 N E S W U	V4 N E S W U	V5 N E S W U	V6 N E S W U
<div style="text-align: right; margin-right: 20px;">INDICATE NORTH</div> <div style="text-align: left; margin-left: 20px;">INDICATE ROAD NAMES</div> <div style="text-align: right; margin-right: 20px;">DIAGRAM NOT TO SCALE</div>							

**WHEN TO COMPLETE A DIAGRAM**

A collision diagram **MUST** be included on all reports where enough evidence and/or facts can be obtained to adequately depict the crash scene. If a diagram is not made, write "None" in *Section 6 - Collision Diagram* and fully describe the crash in *Section 9 - Narrative and Statements*.

**DIAGRAMMING METHODS**

The diagramming method (template, ITE, or computer aided diagram) is a departmental decision. Do not combine template and ITE diagramming methods on the same report. Law enforcement agencies may use pre-drawn diagrams describing a specific location. It is also acceptable to use an additional separate sheet. For a listing of template and ITE symbols refer to [Appendix B](#), page 128.

- a. **COMPASS DIRECTION BEFORE CRASH EVENT(S)** - Circle one letter designating each involved vehicle's true direction of travel **PRIOR TO** the crash event(s). If a vehicle is parked or stopped, enter the direction the vehicle is facing. If a vehicle is turning, show the direction prior to the turn. Mark "U" if the information is unknown.

Example #1: If a vehicle is facing east but backing west, the direction prior to the crash event is west.

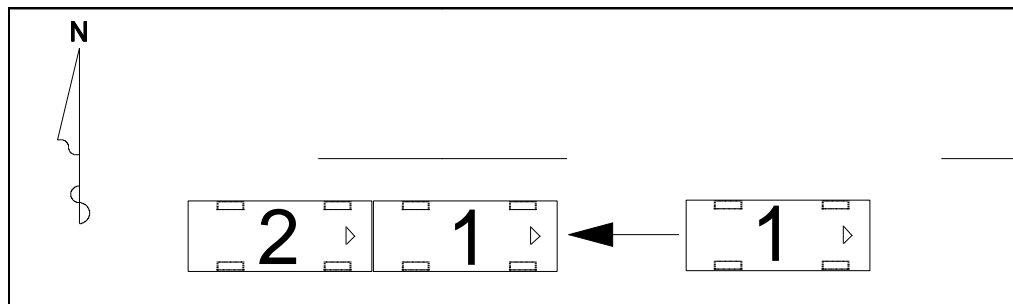

Example #2: If two vehicles are traveling opposite directions and one turns left into the path of the other, show the direction of each vehicle prior to the vehicle turning. In the example, the direction of vehicle #1 is east and the direction of vehicle #2 is west.

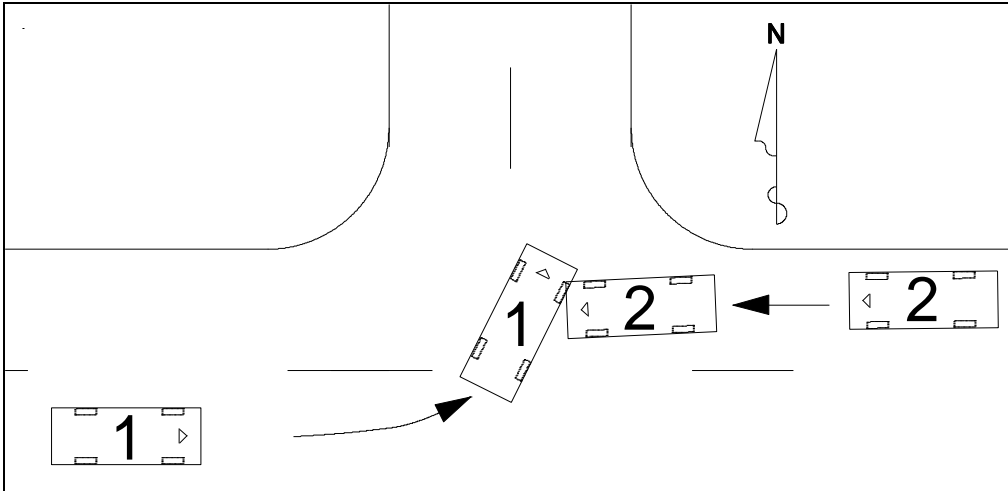

- b. **INDICATE NORTH** - Indicate north by drawing an arrow in the upper right corner.
- c. **DIAGRAM NOT TO SCALE** - If diagram is to scale, cross out "Not."

**Note:** Numbering Roadway Lanes - Engineering standards call for lane numbering on roadways with two or more lanes in the same direction to begin on the inside of the roadway next to the **median** or barrier and progress to the outside lanes (or to the right). This method should be used when referring to lane numbers on the diagram.

Example: Lane one of a roadway with four lanes of travel in the same direction would be the inside lane next to the **median** or barrier and lane four would be the outside lane next to the shoulder (or right side of the roadway). See example below.



VII. **SECTION 7 - DRIVERS, VEHICLES, OWNERS, & OCCUPANTS**

This section contains information about a motor vehicle driver or **other transport device** operator involved in the crash. It also contains pertinent information about the motor vehicle or other transport device involved in the crash including the owner and occupants.

**EXCEPTION** - Show train information on the *Train Crash Continuation / Supplement*.

*Section 7 - Drivers, Vehicles, Owners, and Occupants* must be completed for each vehicle involved in the crash. The standard report includes two pages with this section. Additional pages with this section must be added for crashes involving more than two vehicles.

**PAGE NOT USED** - Mark if the second page with *Section 7 - Drivers, Vehicles, Owners, & Occupants* is not utilized. The page should be counted sequentially as part of the report; however, it is not necessary to enter "NA" in each of the fields.

Page Not Used      REPORT # \_\_\_\_\_      PAGE \_\_\_\_\_ OF \_\_\_\_\_

7 - DRIVERS, VEHICLES, OWNERS, & OCCUPANTS														
NO. <b>7A. DRIVER</b> - NAME (Last, First, MI) & ADDRESS (Street, City, State, Zip)											PHONE NUMBER			
DRIVER LICENSE / ID NUMBER		STATE	LIC STATUS <input type="checkbox"/> Valid <input type="checkbox"/> Expired <input type="checkbox"/> Susp / Rev / Denied <input type="checkbox"/> Disqual CDL <input type="checkbox"/> NA <input type="checkbox"/> Canceled / Oth Invalid <input type="checkbox"/> Unknown			LIC TYPE <input type="checkbox"/> NA <input type="checkbox"/> Operator Class _____ <input type="checkbox"/> CDL Class _____ <input type="checkbox"/> Intern / Grad		<input type="checkbox"/> Permit <input type="checkbox"/> Unknown (Explain) <input type="checkbox"/> MC Only <input type="checkbox"/> Unlicensed		MC ENDORSEMENT <input type="checkbox"/> Yes <input type="checkbox"/> No <input type="checkbox"/> NA <input type="checkbox"/> Unknown (Explain)				
DATE OF BIRTH		SEX	SEAT LOC	INJ	TRANS-PORT	EJEC-TION	AIR BAG	SAFETY DEVICES	VISION OBSTRUCTED <input type="checkbox"/> NA <input type="checkbox"/> Not Obstructed <input type="checkbox"/> Windshield <input type="checkbox"/> Load on Veh		<input type="checkbox"/> Trees / Brush <input type="checkbox"/> Building <input type="checkbox"/> Embankment	<input type="checkbox"/> Sign <input type="checkbox"/> Hillcrest <input type="checkbox"/> Parked Veh	<input type="checkbox"/> Moving Veh <input type="checkbox"/> Stopped Veh <input type="checkbox"/> Glare	<input type="checkbox"/> Other (Explain) <input type="checkbox"/> Unknown (Explain)
PROOF OF INSURANCE <input type="checkbox"/> Yes <input type="checkbox"/> No <input type="checkbox"/> Not Required			INSURANCE COMPANY <input type="checkbox"/> Expired					PHONE NO. (Optional)		POLICY NUMBER <input type="checkbox"/> NA		<input type="checkbox"/> Driver <input type="checkbox"/> Vehicle		

- a. **NO.** - (Number) The vehicle or **other transport device** / driver number assigned by the investigator.

When a non-contact vehicle and /or its driver contribute to a crash, include it in *Section 6 - Collision Diagram* and *Section 9 - Narrative / Statements*, identifying it as "Veh A," "Veh B," etc. Do not include this vehicle and / or its driver in this section.

**7A. DRIVER** (Vehicle driver or **other transport device** operator)

- i. **NAME (LAST, FIRST, MI)** - Enter the driver's current legal name using last name, first name, and middle initial format. **Note:** Do not enter a period after an initial. The name on the driver's license (and the Department of Revenue) may differ from the driver's current legal name.

Enter "None" if there is no driver and enter "Unk" if the driver cannot be identified.

**Note:** A person sitting in the driver's seat of a **"Parked Motor Vehicle"** is shown as an **occupant**, not a driver. The information pertaining to this person is shown in *Section 7F - Occupants*.

- ii. **ADDRESS (STREET, CITY, STATE, ZIP)** - Enter the vehicle driver's most current address.
- iii. **PHONE NUMBER** - Enter the driver's telephone number, including the area code.
- iv. **DRIVER LICENSE / ID NUMBER** - Enter the complete driver license number or identification number from driver license / identification card regardless of the status of the license (i.e. suspended, revoked). If the individual has no license, enter the number assigned by the licensing authority if available.

Enter:

"None" if a license is required and the driver is unlicensed and has no assigned number.

"Unk" if the driver license number cannot be determined.

"NA" if no license is required, the driver is unlicensed, or there is no driver.

- v. **STATE** - Enter state issuing the driver license / identification card using the standard NCIC two-letter abbreviation as shown in [Appendix C - United States, Canada, and Mexico Abbreviations](#), page 133. Enter "XX" for licenses issued by entities not listed in the appendix.
- vi. **LIC. STATUS** - (License Status) Mark one box indicating the status of the driver license.

**Note:** See [Appendix G - Driver License Status and Type](#) on page 187 in reference to specific situations concerning license status and license type.

1. **NA** - Mark in the following circumstances:
  - a. A license is not required
  - b. The driver is unlicensed
  - c. There is no driver.
2. **Valid** - Mark if the driver is required to have a license to operate the particular vehicle and has a valid license.

Mark if an unqualified CDL holder is valid to operate a non-commercial motor vehicle and was operating a non-commercial motor vehicle in the crash.

Mark if the driver is required to have a license to operate the particular vehicle and has a valid temporary permit / privilege or valid instruction permit. This should also be marked when a motorcycle operator has a valid motorcycle permit.

3. **Suspended / Revoked / Denied** - Mark if the driver is required to have a license to operate the particular vehicle and has a suspended, revoked, or denied license or privilege. If applicable, select regardless of whether the operator is authorized / qualified to operate the vehicle. Example: Person is driving a motorcycle without a valid motorcycle license, permit, or endorsement and their license or privilege is suspended.
4. **Canceled / Oth. Invalid** - (Canceled / Otherwise Invalid) Mark if the driver is required to have a license to operate the particular vehicle and has a canceled or otherwise invalid license. This would also apply to a driver who has a valid license however, is not qualified for the vehicle being operated at the time of the crash. "Oth. Invalid" would include failing to comply with restrictions of an intermediate or graduated license, permit, commercial driver license (CDL), etc.

This includes drivers who otherwise have a valid license, but are unqualified to operate a vehicle at the time of the crash (no endorsement for vehicle/load type.)

Mark if a motorcycle operator does not have a valid motorcycle permit or endorsement at the time of the crash.

5. **Expired** - Mark if the driver is required to have a license to operate the particular vehicle and has an expired license that is not suspended, revoked, denied, canceled, or is otherwise invalid.
6. **Disq. CDL** - (Disqualified CDL) Mark if driver is operating a commercial motor vehicle requiring a CDL and the driver's CDL is disqualified.

7. **Unknown** - Mark if the driver is required to have a license to operate the particular vehicle and license status is unknown. Explain in *Section 9 - Narrative / Statements*.
- vii. **LIC. TYPE** - (License Type) Mark one box indicating the type of driver license.

**Note:** See [Appendix G - Driver License Status and Type](#) on page 187 in reference to specific situations concerning license status and license type.

1. **NA** - Mark only if there is no driver or the driver is not required to have a license.
  2. **Operator** - Mark if the driver has a driver license and not a CDL, regardless of the license status.
    - **Class** - Enter appropriate class code listed on the license. Missouri driver license codes shown will either be "E" or "F". Do not list endorsement or restriction codes. If a class code is not listed on an out-of-state license, write "NA." Enter "Unk" if the class is unknown.
  3. **CDL** - Mark if the driver has a CDL, regardless of the license status.
    - **Class** - Enter the appropriate class code listed on the license. Missouri CDL codes are "A," "B," or "C". Do not list endorsement or restriction codes. If a class code is not listed on an out-of-state license, write "NA." Enter "Unk" if the CDL class is unknown.
  4. **Interm / Grad** - (Intermediate / Graduated) Mark if the driver has an intermediate or graduated license, regardless of the license status.
  5. **Permit** - Mark if the driver has a permit, regardless of the license status. This includes driver's license permits or a motorcycle operator with a valid motorcycle permit.
  6. **MC Only** - (Motorcycle Only) Mark if the driver is licensed for a motorcycle ONLY, regardless of the license status.
  7. **Unlicensed** - Mark only if the driver does not have a driver license or permit. This does not include an operator who has a driver license that is suspended, revoked, denied, canceled, expired, or disqualified. In these cases, the actual type of license issued should be marked.
  8. **Unknown (Explain)** - Mark if the driver/operator is required to have a license and license type is unknown. Explain in *Section 9: Narrative / Statements*.
- viii. **MC ENDORSEMENT** - Mark the appropriate box to indicate whether the operator has a motorcycle endorsement.

**Note:** See [Appendix G - Driver License Status and Type](#) on page 187 in reference to specific situations concerning license status and license type.

1. **NA** - Mark "NA" if the driver was not operating a motorcycle or the driver has a motorcycle-only license. Mark NA for motorcycle operators if the license type is not applicable.
2. **Yes** - Mark if the driver was operating a motorcycle and has a motorcycle endorsement. Mark if the motorcycle operator has a driver's permit with a motorcycle endorsement.
3. **No** - Mark if the driver was operating a motorcycle and does not have a motorcycle endorsement. Mark if the motorcycle operator has a motorcycle

permit (valid or invalid) or is unlicensed.

4. **Unknown** - Mark if the driver was operating a motorcycle and it is unknown if he or she has a motorcycle endorsement. **Note:** Mark if the crash involves leaving the scene of a crash and the type of vehicle is unknown. Explain in *Section 9: Narrative / Statements*.

- ix. **DATE OF BIRTH** - Enter the driver's birth date in month, day, and year (mm-dd-yyyy) format. Enter "Unk" if unknown.
- x. **SEX** - Enter "M" for male, "F" for female, "U" if the information is unknown, or "N" if there is no driver.
- xi. **SEAT LOC.** - (Seat Location) Enter the appropriate code to indicate the driver's seat location. "NA" is entered only if there was no driver. Use the codes listed in *Section 8 - Codes*. For a description of the codes, refer to *Section 8 - Codes* in this manual (page 92).

**Note:** A person sitting in the driver's seat of a "Parked Motor Vehicle" is shown as an occupant, not a driver. The information pertaining to this person is shown in Section 7F - Occupants.

When an occupant is sitting on the driver's lap, enter the same seat location code for both and explain in *Section 9 - Narrative and Statements*.

- xii. **INJ - (Injury)** Enter one code to indicate the driver's injury severity. "N" (NA) may be entered only if there was no driver. Use the codes listed in *Section 8 - Codes*. For a description of the codes, refer to *Section 8 - Codes* in this manual (page 93).

**Note:** Injuries should be classified on the basis of conditions at the scene of the crash. The exception to this rule applies to fatal injuries (*late death*). Injuries that do not meet these criteria may be documented in *Section 9 - Narrative / Statements*.

Enter "5" (None Apparent) for drivers who are not injured, but transported from the scene to a medical facility for precautionary measures. Explain in *Section 9 - Narrative / Statements*.

- xiii. **TRANSPORT** - Enter one code to indicate whether and how the driver was transported from the scene to a medical facility for treatment of crash-related injuries. "N" (NA) may be entered only if there was no driver. Use the codes listed in *Section 8 - Codes*. For a description of the codes, refer to *Section 8 - Codes* in this manual (page 94).

List the name of the transporting agency or person, and medical facility they were transported to in *Section 9 - Narrative / Statements* if applicable.

**Note:** Enter "1" (No) for drivers who were not injured, but transported from the scene to a medical facility for precautionary measures. In addition, mark "No" if a person deceased at the scene was transported. In either case, explain in *Section 9 - Narrative / Statements*.

- xiv. **EJECTION** - Enter one code to indicate whether the driver was ejected from the vehicle. "1" (NA) may be entered only if there was no driver. Show ejection codes for all types of vehicles, including motorcyclists, bicyclists, and *other transport devices*. Use the codes listed in *Section 8 - Codes*. For a description of the codes, refer to *Section 8 - Codes* in this manual (page 95).

**Note: All Fatality Crashes** - Identify ejection path (windshield, door, t-top, etc.) of **everyone ejected in a fatality crash** in *Section 9 - Narrative / Statements*. This is not applicable for cyclists.



- xv. **AIR BAG** - Enter one code to indicate if air bags were present for the driver and whether any airbags were deployed. Use the codes listed in *Section 8 - Codes*. For a description of the codes, refer to *Section 8 - Codes* in this manual (page 95).
- xvi. **SAFETY DEVICES** - Enter a maximum of two codes to indicate the type of **safety device(s)** used, if any, by the driver. If only one safety device is applicable, then leave the second safety device field blank. Use the codes listed in *Section 8 - Codes*. For a description of the codes, refer to *Section 8 - Codes* in this manual (page 97).
- xvii. **VISION OBSTRUCTED** - This section identifies driver vision obstructions. Vision obstructions are anything that blocks the driver's sight, contributing to the crash. Mark all that are applicable. No other selections may be made if "NA," "Not Obstructed," or "Unknown" is marked.
  1. **NA** - Mark if there was no driver, as in the case of a **parked motor vehicle**. This may not be marked if "*Vision Obstruction*" is marked in *Section 7D - Probable Contributing Circumstances*.
  2. **Not Obstructed** - Mark to indicate the driver's vision was not obstructed. This may not be marked if "*Vision Obstructed*" is marked in *Section 7D - Probable Contributing Circumstances*.
  3. **Windshield** - Mark if defects in the windshield (e.g., broken glass) or something on the windshield such as water, mud, dirt, frost, snow, etc. obstructed the driver's vision.
  4. **Load on Veh** - Mark if the load or cargo on the driver's vehicle obstructed the driver's vision.
  5. **Trees / Brush** - Mark if trees, brush, or other vegetation obstructed the driver's vision.
  6. **Building** - Mark if building(s) obstructed the driver's vision.
  7. **Embankment** - Mark if an embankment obstructed the driver's vision.
  8. **Sign** - Mark if a sign obstructed the driver's vision.
  9. **Hillcrest** - Mark if a hillcrest obstructed the driver's vision.
  10. **Parked Veh** - Mark if a parked vehicle obstructed the driver's vision.
  11. **Moving Veh** - Mark if a moving vehicle other than the driver's vehicle, obstructed the driver's vision.
  12. **Stopped Veh** - Mark if a stopped vehicle obstructed the driver's vision.
  13. **Glare** - Mark if glare from the sun or other light source obstructed the driver's vision. This includes reflections.
  14. **Other (Explain)** - Mark if the driver's vision was obstructed and none of the above apply. Explain in *Section 9 - Narrative / Statements*.
  15. **Unknown (Explain)** - Mark if it cannot be determined or it is unknown if the driver's vision was obstructed. Explain in *Section 9 - Narrative / Statements*.

xviii. **PROOF OF INSURANCE** - This includes proof of insurance issued by an insurance carrier or proof of financial responsibility issued by the Missouri Department of Revenue.

1. **Yes** - Mark anytime proof of insurance or financial responsibility is shown. This is regardless of whether proof is required or not-
2. **No** - Mark when proof of insurance or financial responsibility is required, but not provided. This should be marked when an expired insurance card is provided and proof is required.
3. **Not Required** - Mark when proof is not required and is not shown.

**Note:** Proof of insurance is required for all vehicles (Missouri and out-of-state) except for commercial motor vehicles registered out-of-state or vehicles owned by government entities.

xix. **INSURANCE COMPANY** - Enter insurance company's name as shown on proof of insurance. If proof is not required, insurance company's name should be entered to facilitate claim processing by crash victims. Enter "Self Insured" if applicable.

Enter "NA" if proof is not shown (required or not).

**Expired** - Mark if expired proof of insurance is presented. The company name should still be entered in the field even if the proof of insurance is expired.

xx. **PHONE NO. (OPTIONAL)** - Enter insurance company's telephone number, including the area code. Enter "NA" if the information is unknown, not obtained, or this field does not apply.

xxi. **POLICY NUMBER** - Enter insurance policy number as shown on the proof of insurance. Enter number even if expired proof of insurance is presented. Enter "Unknown" if proof is shown; however, the policy number is obliterated or unavailable.

**NA** - Mark if the vehicle or driver is uninsured or the driver fails to show proof of liability insurance. Do not mark "NA" if expired proof of insurance is presented.

xxii. **DRIVER** - Mark to indicate the driver's insurance policy covers any vehicle he/she drives, but the vehicle is not insured.

xxiii. **VEHICLE** - Mark to indicate the vehicle is insured as required.

## 7B. VEHICLE

7B. VEHICLE - OWNER NAME (Last, First, MI) & ADDRESS (Street, City, State, Zip) <input type="checkbox"/> SAD						PHONE NUMBER <input type="checkbox"/> SAD	
YEAR	MAKE	MODEL		COLOR	VEH. TYPE	TOTAL NO. OF OCC.	
LICENSE - PLATE NO.	STATE	YEAR	VIN	TOWED FROM SCENE <input type="checkbox"/> Yes <input type="checkbox"/> No		TOWED DUE TO DIS. DAMAGE <input type="checkbox"/> Yes <input type="checkbox"/> No	
VEHICLE DAMAGE (Mark all damaged areas) <input type="checkbox"/> None / No Damage				TOWED BY <input type="checkbox"/> Unknown <input type="checkbox"/> NA			
INITIAL IMPACT NO:		18 - Undercarriage		22 - Cargo			
15   16   17		19 - Windshield		23 - Unknown			
14   13   12   11   10   9		20 - Burned		24 - Other (Explain)			
<input type="checkbox"/> NA		21 - Towed Unit					
VEHICLE BODY TYPES - Automobiles / Specialty Vehicles <input type="checkbox"/> Vehicle Used As Public Conveyance							
<input type="checkbox"/> Passenger Car	<input type="checkbox"/> Small Bus (9-15 W/Driver)	<input type="checkbox"/> Motorcycle	<input type="checkbox"/> Motor Home	<input type="checkbox"/> Single-unit Truck; 2 axles, 6 tires	GVW / GCVW RATING (Not Licensed Weight) (Pickups, Cargo Vans, All Trucks, Truck Tractors, or Haz Mat Placard Veh. Only) <input type="checkbox"/> Less than or equal to 10,000 lbs. <input type="checkbox"/> 10,001 - 26,000 lbs. <input type="checkbox"/> Greater than 26,000 lbs. <input type="checkbox"/> Unknown		
<input type="checkbox"/> Van (< 9 W/Driver)	<input type="checkbox"/> Large Bus (16+ W/Driver)	<input type="checkbox"/> ATV	<input type="checkbox"/> Farm Implements	<input type="checkbox"/> Single-unit Truck; 3 or more axles			
<input type="checkbox"/> Passenger Van (9+ W/Driver)	<input type="checkbox"/> School Bus	<input type="checkbox"/> 2 Wh	<input type="checkbox"/> Construction Equip. Heavy Mach.	<input type="checkbox"/> Veh. Pulling Another Unit(s) (Does not apply to Truck Tractors)			
<input type="checkbox"/> Sport Utility Vehicle	<input type="checkbox"/> Intercity	<input type="checkbox"/> 3 Wh	<input type="checkbox"/> Other Vehicle (Code) _____	<input type="checkbox"/> Truck Tractor With No Units			
<input type="checkbox"/> Limousine (7-8 W/Driver)	<input type="checkbox"/> Transit / Commuter	<input type="checkbox"/> 4 Wh	<input type="checkbox"/> Cargo Van	<input type="checkbox"/> Truck Tractor With One Unit			
<input type="checkbox"/> Limousine (9-15 W/Driver)	<input type="checkbox"/> Charter / Tour	<input type="checkbox"/> 5 Wh / More	<input type="checkbox"/> Pickup	<input type="checkbox"/> Truck Tractor With Two Units			
<input type="checkbox"/> Motorized Bicycle	<input type="checkbox"/> Other	<input type="checkbox"/> Unknown	<input type="checkbox"/> Other Heavy Truck	<input type="checkbox"/> Truck Tractor With Three Units			
<input type="checkbox"/> Pedalcycle <input type="checkbox"/> To / From School			<input type="checkbox"/> Unknown (Explain)				
EMERGENCY VEHICLE INVOLVEMENT <input type="checkbox"/> NA				CONTRIBUTING TRAFFIC CONDITIONS <input type="checkbox"/> NA			
<input type="checkbox"/> Police	<input type="checkbox"/> Ambulance	<input type="checkbox"/> A. Emergency Vehicle on Emergency Run		<input type="checkbox"/> Congestion Ahead	<input type="checkbox"/> Other Incident Ahead		
<input type="checkbox"/> Fire	<input type="checkbox"/> Other (Must check "A" / "B") →	<input type="checkbox"/> B. Stationary With Emergency Equip. Activated		<input type="checkbox"/> Crash Ahead	<input type="checkbox"/> Unknown (Explain)		

- i. **OWNER NAME (LAST, FIRST, MI) & ADDRESS (STREET, CITY, STATE, ZIP)** - Enter the vehicle owner's name and most current address. The name on the vehicle registration may differ from the owner's current legal name. Enter owner's current legal name using last name, first name, and middle initial format. **Note:** Do not enter a period after an initial.

Enter "Unknown" if the owner cannot be determined.

**SAD** - (Same as Driver) - Mark if the driver is the owner of the vehicle. No further information is needed in this field if this box is marked.

- ii. **PHONE NUMBER** - Enter the vehicle owner's telephone number, including the area code.

**SAD** - (Same as Driver) - Mark if the driver is the owner of the vehicle. No further information is needed in this field if this box is marked.

- iii. **YEAR** - Enter four-digit vehicle model year. If in doubt, use year indicated on title or as obtained from the Department of Revenue.
- iv. **MAKE** - Enter the vehicle make. Use the appropriate NCIC code or the complete name.
- v. **MODEL** - Enter the manufacturer's vehicle model designation. Use the appropriate NCIC code or the complete name.
- vi. **COLOR** - Enter the vehicle color(s) starting at the top. Use NCIC codes below. Example: "BLK" | "RED" indicates the vehicle is predominately black on top and red on the bottom.

### VEHICLE COLOR ABBREVIATIONS

BGE	Beige	DBL	Dk. Blue	MAU	Mauve	SIL	Silver /
BLK	Black	DGR	Dk. Green	MUL	Multicolored		Aluminum
BLU	Blue	GLD	Gold	ONG	Orange	TAN	Tan
BRO	Brown	GRN	Green	ORC	Orchid	TAU	Taupe
BRZ	Bronze	GRY	Gray	PEA	Peach	TEA	Teal
CHA	Charcoal	LAV	Lavender	PEW	Pewter	TRQ	Turquoise
COM	Chrome /	LBL	Lt. Blue	PLE	Purple	WHI	White
	Stainless	LGR	Lt. Green	PNK	Pink	WIN	Wine
CPR	Copper	MAR	Maroon /	PRI	Primer	WOD	Woodgrain
CRM	Cream/Ivory		Burgundy	RED	Red	YEL	Yellow
				RUS	Rust	999	Unknown Color

- vii. **VEH. TYPE** - (Vehicle Type Code) Enter the code that represents the type of vehicle at the time it became involved in the crash. This describes how the vehicle was being used at the time of the crash and excludes aircraft, watercraft, [personal conveyances](#) (motorized or human powered but not propelled by pedaling), weapon, and devices operated within the confines of a building. Use the codes listed below.
  1. **Motor Vehicle in Transport** - A motor vehicle being used for moving persons or property from one place to another, and is either in motion, in readiness for motion, or on a roadway, but not parked in a designated area. Includes a motor vehicle moving, stopped, disabled, or abandoned on a roadway other than areas designated for parking. See examples for [Motor Vehicle in Transport](#) in Glossary, page 19.

2. **Parked Motor Vehicle** - A motor vehicle not in-transport, other than a [working motor vehicle](#), that is not in motion and not located on the roadway. A "parked motor vehicle" should be considered to be in-transport during periods when parking is prohibited in roadway lanes used for travel during some periods and for parking during other periods. (See page 31, [Parked MV](#), for inclusions and exclusions).
  3. **Working Motor Vehicle** - A motor vehicle in the act of performing construction, maintenance, or utility work related to the [trafficway](#). This "work" may be located within open or closed portions of the trafficway and motor vehicles performing these activities can be within or outside of the trafficway boundaries. For instance, a utility truck parked off the trafficway in a field placing a concrete culvert on the trafficway. (See page 32, [Working MV](#), for inclusions and exclusions).
  4. **Pedalcycle** - A non-motorized device operated solely by pedals propelled by human power. (See page 28, [Pedalcycle](#), for inclusions and exclusions).
  5. **Animal Drawn Vehicle / Animal Ridden for Transport Purposes** - A vehicle or conveyance drawn by an animal for transportation purposes or an animal being ridden by a person(s) for transportation purposes.
- U. **Unknown** - The type of vehicle is unknown.
- viii. **TOTAL NO. OF OCC.** - (Total Number of Occupants) Enter the total number of vehicle [occupants](#), including the driver and persons in or on the vehicle at the time of the first [unstabalized event](#).
  - ix. **LICENSE - PLATE NO.** - Enter the license plate number. If a vehicle has no plates or "homemade" plates, i.e., substitutes for lost or stolen plates, enter "NONE." When a towed unit is involved, enter the license plate number of the power unit (vehicle pulling the trailer).  
  
Enter:  
**"NOTREQ"** when a crash involves a vehicle not requiring a license and not displaying a license plate (i.e., government owned vehicles, self propelled construction equipment, well-driller, etc.).  
**"TEMP"** if the vehicle has valid temporary or in-transit license.  
**"Unk"** if the plate number is unknown.
  - x. **STATE** - Enter state / province issuing the vehicle license using the standard NCIC two letter abbreviation as shown in [Appendix C - United States, Canada, and Mexico Abbreviations](#), page 133. Enter "XX" for licenses issued by entities not listed in the appendix. Enter "NA," if NONE or NOTREQ is entered as the license plate number. Enter "UK" if the state is unknown.
  - xi. **YEAR** - Enter four-digit year designation of plate. Enter the current year for license plates not displaying a year, such as an apportioned plate. Enter "NA," if NONE or NOTREQ is entered as the license plate number. Enter "Unk" if the year is unknown.
  - xii. **VIN** - Enter the vehicle identification number (VIN) as shown on the vehicle.
  - xiii. **TOWED FROM SCENE** - Mark the appropriate box to indicate whether the vehicle was towed from the scene. Vehicles driven from the scene under their own power cannot be listed as towed.
    1. **Yes** - Vehicle was towed FROM THE SCENE for any reason. This includes times when the driver is arrested or injured and the vehicle is towed. This includes vehicles that are not towed at the time of the investigation, but the reporting officer knows will be towed at a later time.

Note: Mark "yes" if a trailer being pulled by a vehicle is towed from the scene, even if the power unit is not towed.

2. **No** - Vehicle was not towed from the scene. Mark "No" if a tow truck or other vehicle was required to pull vehicle back onto the roadway; however, the involved vehicle then left the scene under its own power.

xiv. **TOWED DUE TO DIS. DAMAGE-** (Towed Due to Disabling Damage) Mark the appropriate box to indicate if the vehicle was towed due to disabling **damage**.

1. **Yes** - Vehicle was towed (or will be towed) from the scene resulting from disabling **damage** received in the crash. "Yes" under "Towed from Scene" must be marked.

Note: Mark "yes" if a trailer being pulled by a vehicle is towed due to disabling damage to the trailer, even if the power unit is not towed or is towed, but not due to disabling damage.

2. **No** - One or more of the following apply:
  - a. The vehicle was not towed. "No" under "Towed from Scene" must be marked.
  - b. The vehicle was towed from the scene; however, the **damage** it sustained in the crash was not disabling. For example, the driver was transported to a medical facility or arrested and the vehicle was towed for safekeeping.

xv. **VEHICLE DAMAGE** - Indicate damage sustained by the vehicle, if any, during the crash.

VEHICLE DAMAGE (Mark all damaged areas)							<input type="checkbox"/> None / No Damage	
INITIAL IMPACT NO:	2	3	4	5	6	7	18 - Undercarriage	22 - Cargo
<input type="checkbox"/> NA	1	15	16	17	8	9	19 - Windshield	23 - Unknown
	14	13	12	11	10		20 - Burned	24 - Other (Explain)
							21 - Towed Unit	

1. **None / No Damage** - Mark if the vehicle, including any towed unit and / or cargo, was not damaged.
2. **Initial Impact No.** - Enter the number corresponding to the initial impact point on the vehicle, e.g., if the initial impact point was on the towed unit, enter "21"; if initial impact was to the cargo, enter "22". Enter the initial impact number if contact was made, even if there was no apparent **damage**.

**Note:** "20 - Burned" cannot be entered as an initial impact number.

**NA** - Mark if there was no impact, e.g., an **occupant** falls from a vehicle and is injured but there is no vehicle impact, or vehicle is immersed in water and there was no initial impact other than with the water.

3. **Vehicle Damage** - Circle number(s) corresponding to the damaged areas of the vehicle.

Circle "20 - Burned" when a vehicle is damaged by fire, even if there is no impact or damage other than that caused by burning.

Circle "22 - Cargo" when cargo becomes disengaged from the vehicle and is

damaged. Disengaged cargo becomes an "Other object" once it comes to rest.

Circle "24 - Other" for damage due to the vehicle being immersed, e.g., interior damage. Damage from impact following immersion should be marked with the number corresponding to the damage sustained.

- xvi. **TOWED BY** - Enter the name, address, and telephone number (including area code) of the tow company or individual that towed the vehicle from the scene.

**Unknown** - Mark if the vehicle was towed and the company or individual towing it cannot be determined.

**NA** - Mark if the vehicle was not towed. This must be marked if "No" is marked in *Section 7 - Towed From Scene*.

- xvii. **VEHICLE BODY TYPES** - This sub-section identifies body types of all vehicles involved. Body type identification is based on vehicle design, NOT how it is licensed or used.

VEHICLE BODY TYPES - Automobiles / Specialty Vehicles		<input type="checkbox"/> Vehicle Used As Public Conveyance	
<input type="checkbox"/> Passenger Car	<input type="checkbox"/> Small Bus (9-15 W/Driver)	<input type="checkbox"/> Motorcycle	<input type="checkbox"/> Motor Home
<input type="checkbox"/> Van (< 9 W/Driver)	<input type="checkbox"/> Large Bus (16+ W/Driver)	<input type="checkbox"/> ATV	<input type="checkbox"/> Farm Implements
<input type="checkbox"/> Passenger Van (9+ W/Driver)	<input type="checkbox"/> School Bus	<input type="checkbox"/> 2 Wh	<input type="checkbox"/> Construction Equip. Heavy Mach.
<input type="checkbox"/> Sport Utility Vehicle	<input type="checkbox"/> Intercity	<input type="checkbox"/> 3 Wh	<input type="checkbox"/> Other Vehicle (Code) _____
<input type="checkbox"/> Limousine (7-8 W/Driver)	<input type="checkbox"/> Transit / Commuter	<input type="checkbox"/> 4 Wh	<input type="checkbox"/> Pickup
<input type="checkbox"/> Limousine (9-15 W/Driver)	<input type="checkbox"/> Charter / Tour	<input type="checkbox"/> 5 Wh / More	<input type="checkbox"/> Cargo Van
<input type="checkbox"/> Motorized Bicycle	<input type="checkbox"/> Other	<input type="checkbox"/> Unknown	<input type="checkbox"/> Other Heavy Truck
<input type="checkbox"/> Pedalcycle			<input type="checkbox"/> Unknown (Explain)
<input type="checkbox"/> To / From School			<input type="checkbox"/> Single-unit Truck; 2 axes, 6 tires
			<input type="checkbox"/> Single-unit Truck; 3 or more axes
			<input type="checkbox"/> Veh. Pulling Another Unit(s) (Does not apply to Truck Tractors)
			<input type="checkbox"/> Truck Tractor With No Units
			<input type="checkbox"/> Truck Tractor With One Unit
			<input type="checkbox"/> Truck Tractor With Two Units
			<input type="checkbox"/> Truck Tractor With Three Units
			<b>GVW / GCW RATING</b> (Not Licensed Weight) (Pickups, Cargo Vans, All Trucks, Truck Tractors Only)
			<input type="checkbox"/> Less than or equal to 10,000 lbs.
			<input type="checkbox"/> 10,001 - 26,000 lbs.
			<input type="checkbox"/> Greater than 26,000 lbs.
			<input type="checkbox"/> Unknown

**Vehicle Used as Public Conveyance** - Mark if the vehicle is a [public conveyance](#).

A public conveyance is a motor vehicle, either publicly or privately owned, engaged in the business of passenger transportation services. This includes, but is not limited to, buses, taxis, limousines, and shuttle services with or without passengers at the time of the crash. Private car pooling is not included under this definition.

1. **Passenger Car** - A motor vehicle other than the vehicles listed below typically designed for carrying eight or fewer persons. Includes sedans, hardtops, hatchbacks, convertibles, and station wagons.
2. **Van (<9 w/ Driver)** - Includes passenger vans with a seating capacity of less than 9 only and does not include cargo vans. Also includes mini-vans. A passenger van is a motor vehicle which is basically a "box on wheels" identifiable by its enclosed passenger area, step-up floor, and relatively short (or non-existent) hood.
3. **Passenger Van (9+ w/ Driver)** - Includes passenger vans with a seating capacity of 9 or more including the driver. A passenger van is a motor vehicle which is basically a "box on wheels" identifiable by its enclosed passenger area, step-up floor, and relatively short (or non-existent) hood.
4. **Sport Utility Vehicle** - A motor vehicle designed for carrying ten or fewer persons, and generally considered a multi-purpose vehicle that is designed to have off-road capabilities. These vehicles are generally, but not always, four-wheel-drive and have increased ground clearance.

Includes vehicles like Blazer, Jimmy, Durango, 4Runner, Cherokee, Comanche, Explorer, Excursion, Suburban, Highlander, Sequoia, Rav4, Hummer, Armada, Xterra, Tahoe, etc.

**Note:** Four-wheel-drive passenger cars are not considered sport utility vehicles. They are considered passenger cars, unless they fit any of the other descriptions listed.

5. **Limousine (7-8 w/ Driver)** - Any motor vehicle OPERATING IN [INTRASTATE COMMERCE](#) having a seating capacity of 7 to 8 [occupants](#). A private limousine not used in intrastate commerce should be shown as a "passenger car."
6. **Limousine (9-15 w/ Driver)** - Any motor vehicle operating in commerce having a seating capacity of 9 to 15 [occupants](#). Normally a stretched vehicle. A private limousine not used in intrastate commerce should be shown as a "passenger car."
7. **Motorized Bicycle** - Any two or three-wheeled device having an automatic transmission and a motor with a cylinder capacity of not more than fifty cubic centimeters, capable of producing less than three gross brake horsepower, and propelling the device no faster than thirty miles-per-hour on level ground.

Includes a MOPED, which is a speed-limited motor-driven cycle which may be propelled by pedaling.

8. **Pedalcycle** - A non-motorized vehicle propelled by pedaling. Includes bicycle, tricycle, unicycle, pedal car, etc.

**To/From School** - Mark if the individual using the pedalcycle involved in the crash was traveling to or from a primary or secondary school (grades K through 12).

9. **Small Bus / Large Bus** - A bus is a motor vehicle with seating capacity of nine or more persons, including the driver.
  - a. **Small Bus (9 - 15 w/ Driver)** - A bus with seating capacity of nine to fifteen persons, including the driver.
 

It does not include a van-based bus (passenger van) or a [limousine](#).
  - b. **Large Bus (16+ w/ Driver)** - A bus with seating capacity of sixteen or more persons, including the driver.
  - c. Sub-categories of small bus and large bus: One must be selected when small bus or large bus is identified as a body type.
    - i. **School Bus** - A motor vehicle used for the transportation of any school pupil at or below the 12th grade level to or from a public or private school or school-related activity.

A motor vehicle is a [school bus](#) only if it is externally identifiable by the following characteristics:

1. Its color is yellow
2. Equipped with red lights capable of flashing on front and rear
3. The words "school bus" appear on the front and rear
4. Lettering on both sides identifies the school or school district served, or the company operating the bus.

Includes (but is not limited to):

- Any vehicle which meets the above criteria.

- Any such vehicle going to pick up, or returning from delivering school pupils.

Excludes:

- Trips which involve the transportation exclusively of non-student passengers or exclusively for purposes other than school-related activities. Example: A bus being used to transport non-school pupils such as senior citizens or migrant workers.

- ii. **Intercity** - A bus used for long-distance passenger transportation between cities over fixed routes with regular schedules.

Includes a cross-country bus and buses that service between cities some distance apart, not cities that share borders.

Examples: Greyhound or Trailways bus

- iii. **Transit / Commuter** - A bus used for passenger transportation over fixed, scheduled routes within primarily urban geographical areas.

Includes service within a city and between cities that share borders.

Examples: City metro or a trolley (on highway tires).

- iv. **Charter / Tour** - A bus providing contract service for a group tour or outing, usually on a round-trip basis.

This does not include a [limousine](#).

- v. **Other** - Any bus used for transportation purposes other than [school bus](#), transit/commuter bus, intercity bus, or charter/tour bus.

Includes (but is not limited to):

- Private company providing transportation services for its own employees and others (hotel shuttles, etc.)
- Non-governmental organization (such as churches and non-profit groups)
- Non-educational unit of government (such as Department of Corrections).

## 10. **Motorcycle / ATV**

- a. **Motorcycle** - Any motor vehicle having a seat or saddle for the use of its operator and traditionally designed to travel on not more than three wheels in contact with the ground. Non-traditional designs exist with more than three wheels and these may be considered a motorcycle. Explain in *Section 9 - Narrative / Statements* if a non-traditional motorcycle is involved.
- b. **ATV** - An all-terrain vehicle (ATV) is a three- or more-wheeled vehicle primarily designed for off-road use, e.g., John Deere Gator, Kawasaki



Mule, Honda Four-Trax, Polaris, Arctic-Cat, etc.

- c. Sub-categories of motorcycle and ATV: One must be selected to indicate the wheel configuration when motorcycle or ATV is identified as a body type.
  - i. **2 Wh** - Mark when a motorcycle has only two wheels. This cannot be selected for an ATV.
  - ii. **3 Wh** - Mark when a motorcycle or ATV has three wheels.
  - iii. **4 Wh** - Mark when a motorcycle or ATV has four wheels.
  - iv. **5 Wh / More** - Mark when a motorcycle or ATV has five or more wheels.
  - v. **Unknown** - Mark when this information is unknown. Explain in *Section 9 - Narrative / Statements*.

- 11. **Motor Home** - A motor vehicle which is a recreational unit suitable to live in and drive cross country, and is mounted on a bus/truck chassis. This does not include pick-up truck slide-in camping units or camper shells.
- 12. **Farm Implements** - Unlicensed motor vehicle typically used for agricultural purposes such as a tractor, combine, cotton picker, etc.
- 13. **Construction Equip. / Heavy Mach.** - Unlicensed heavy duty motor vehicle specially designed for executing construction tasks.
- 14. **Other Vehicle (Code)** - Any vehicle involved in the crash that is not described by any of the other descriptions shown. Enter the code for the device listed below on the line.
  - 1. **Riding Mower / Garden Tractor** - Device originally constructed as a lawn mower or garden tractor.
  - 2. **Golf Cart** - Device originally constructed as an electric or gasoline powered golf cart. This includes any modified or hybrid golf cart converted for transportation use only.
  - 3. **Snowmobile** - A motorized vehicle with runners and a continuous track, used for traveling over snow.
  - 4. **Forklift** - A motorized lifting device with two long rigid steel bars that can be raised and lowered, used especially to move pallets loaded with boxes or other goods.
  - 5. **Animal Drawn Vehicle / Animal Ridden for Transportation** - A vehicle or conveyance drawn by an animal for transportation purposes or an animal being ridden by a person(s) for transportation purposes.
  - 6. **Low Speed Vehicle (LSV)** - A motor vehicle with four or more wheels whose top speed is greater than 20 miles-per-hour, but not greater than 25 miles-per-hour.

LSVs are required to be equipped with basic items of safety equipment: tail lamps, reflex reflectors, parking brake, windshields constructed with safety glass, rearview mirrors, seat belts, and vehicle identification numbers.

7. **Other (Explain)** - Includes all other vehicles that do not fall into the previous categories (e.g. mini-truck).



(Mini-truck)

15. **Cargo Van** - A van where the area behind the driver or cab is designed for transporting cargo. This is a 2 axle, 4 tire vehicle only.
16. **Pickup** - A motor vehicle having two axles and four tires with a rear cargo area (bed) separate from the passenger compartment and with a gross vehicle weight rating (GVWR) 26,000 pounds or less. Examples include Ford F150, 250, or 350; Chevrolet 1500, 2500, 3500, El Camino, Ranchero, Ridgeline, Avalanche, Brat, Ram, etc.
17. **Other Heavy Truck** - A motor vehicle having two axles and four tires with a gross vehicle weight rating (GVWR) more than 26,000 pounds.
18. **Unknown (Explain)** - Mark if the vehicle body type cannot be determined.
19. **Single-unit Truck; 2 axles, 6 tires** - A truck consisting of one unit having 2 axles and 6 tires. This includes, but is not limited to, pickup trucks with four tires on the rear axle and ambulances with this configuration.
20. **Single-unit Truck; 3 or more axles** - A truck consisting of one unit having 3 or more axles. Examples include single unit dump trucks, concrete mixers, etc. This does not include truck-tractors.
21. **Vehicle Pulling Another Unit(s)** - Mark if any of the vehicles listed above are pulling a towed unit. This does not apply to [truck tractors](#) (below).
22. **Truck Tractor With No Units** - A [truck tractor](#) with no towed units. Commonly known as a "Bobtail." Examples include Kenworth, Peterbilt, Freightliner, White, Volvo, International, etc.
23. **Truck Tractor With One Unit** - A [truck tractor](#) with one towed unit attached. The towed unit may include box trailer, flatbed, car hauler, grain trailer, tank trailer, pole trailer, etc.
24. **Truck Tractor With Two Units** - A [truck tractor](#) with two towed units attached. Commonly known as a "double bottom." The towed units may include box trailers, flatbeds, grain trailers, tank trailers, etc.
25. **Truck Tractor With Three Units** - A [truck tractor](#) with three towed units attached.
26. **GVW / GCVW Rating** - The gross vehicle weight rating (GVWR) in the case of a single unit vehicle or the gross combined vehicle weight rating (GCVWR) in the case of a vehicle combination (power unit plus towed unit(s)). This is not the licensed weight. It only applies to pickups, cargo vans, all trucks, truck tractors

or vehicles with a hazardous materials placard.

- a. **Less than or equal to 10,000 lbs.** - Mark if the GVWR or GCVWR is less than or equal to 10,000 pounds.
- b. **10,001 - 26,000 lbs.** - Mark if the GVWR or GCVWR is 10,001 to 26,000 pounds.
- c. **Greater than 26,000 lbs.** - Mark if the GVWR or GCVWR is greater than 26,000 pounds.
- d. **Unknown** - Mark if the vehicle meets the criteria where the GVWR or GCVWR is required for the report; however, it cannot be determined. Explain in *Section 9 - Narrative / Statements*.

Location of GVWR tags:

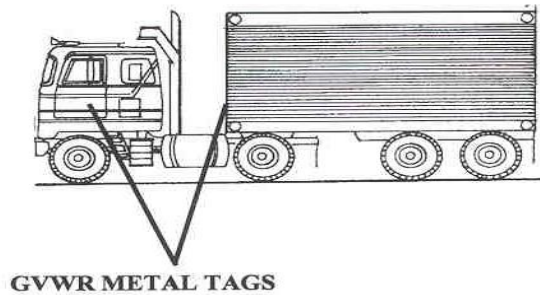

Examples of GVWR tags:

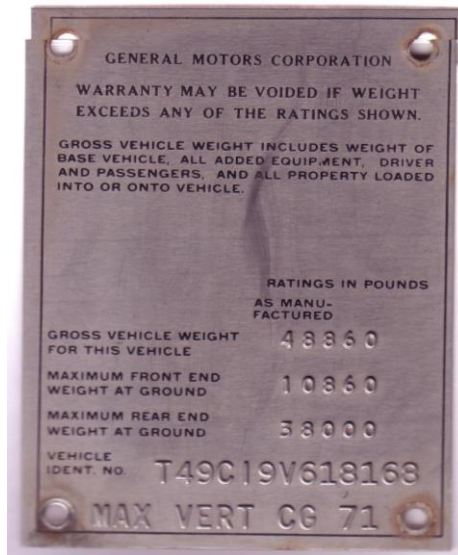



xviii. **EMERGENCY VEHICLE INVOLVEMENT** - This sub-section indicates operation of any motor vehicle equipped with emergency lights and/or siren that is legally authorized under Section 304.022 RSMo, to respond to emergencies with or without the use of emergency warning equipment.

EMERGENCY VEHICLE INVOLVEMENT				<input type="checkbox"/> NA
<input type="checkbox"/> Police	<input type="checkbox"/> Ambulance	<input type="checkbox"/> A. Emergency Vehicle on Emergency Run		
<input type="checkbox"/> Fire	<input type="checkbox"/> Other (Must check "A" / "B")	→	<input type="checkbox"/> B. Stationary With Emergency Equip. Activated	

1. **NA** - Mark when no emergency vehicle was involved.
2. **Police** - Mark if the vehicle was a police vehicle, equipped with emergency lights and/or siren, regardless of markings. A or B (below) must be marked if emergency equipment was activated.
3. **Fire** - Mark if the vehicle was a fire department vehicle equipped with emergency lights and/or siren, regardless of markings. A or B (below) must be marked if emergency equipment was activated.
4. **Ambulance** - Mark if the vehicle was an ambulance. A or B (below) must be marked if emergency equipment was activated.
5. **Other (Must check "A" / "B")** - Mark if the vehicle was not police, fire, or ambulance; however, it was equipped with emergency lights and/or siren and met the statutory requirements for an emergency vehicle given the circumstances. This would include a wrecker making an emergency run to a crash scene, volunteer fire fighter responding to a fire in a personally owned vehicle, or public utility / public service corporation while performing emergency service. A or B (below) must be marked if this is marked.
  - A. **Emergency Vehicle on Emergency Run** - Mark if the emergency vehicle was on an emergency run (moving with emergency equipment activated) at the time of the crash.
  - B. **Stationary with Emergency Equip. Activated** - Mark if the emergency vehicle was stationary with emergency equipment activated when the crash occurred.

xix. **CONTRIBUTING TRAFFIC CONDITIONS** - This sub-section describes traffic conditions at the time of the crash.

CONTRIBUTING TRAFFIC CONDITIONS				<input type="checkbox"/> NA
<input type="checkbox"/> Congestion Ahead	<input type="checkbox"/> Other Incident Ahead			
<input type="checkbox"/> Crash Ahead	<input type="checkbox"/> Unknown (Explain)			

1. **NA** - Mark if none of the below selections apply. NA should be marked if traffic conditions were normal or traffic congestion did NOT contribute to the crash.

2. **Congestion Ahead** - Mark if heavy volume of traffic caused congestion, which contributed to the crash. The congestion was not caused by a traffic crash or other incident.
3. **Crash Ahead** - Includes instances where congestion is caused by a traffic crash and contributes to this crash.
4. **Other Incident Ahead** - Includes instances where an incident other than a traffic crash has created congestion, which contributed to this crash. An example would include traffic congestion due to a disabled vehicle.
5. **Unknown (Explain)** - Mark if the traffic conditions at the time of the crash cannot be determined. Explain in *Section 9 - Narrative / Statements*.

**7C. VEHICLE ACTION / SEQUENCE OF EVENTS CODES**

This sub-section describes vehicle action(s) just prior to the first **unstabilized event** to final rest. All sequence of events, animal codes, and fixed object codes must be explained in *Section 9 - Narrative / Statements*. All codes are listed in *Section 8 - Codes*, page 92.

7C. VEHICLE ACTION / SEQUENCE OF EVENTS CODES										<input type="checkbox"/> Additional Codes Listed in Narrative (See Codes in Section 8)		ALCOHOL USE	
SEQUENCE OF EVENTS CODES				<input type="checkbox"/> Unknown		ANIMAL CODE(S)		FIXED OBJECT CODE(S)		<input type="checkbox"/> Yes <input type="checkbox"/> Unk		<input type="checkbox"/> No <input type="checkbox"/> NA	

- i. **Additional Codes Listed In Narrative** - Mark if there are more than fifteen sequence of events codes. Codes in excess of fifteen should be listed in *Section 9 - Narrative / Statements*.
- ii. **Unknown** - Mark if the vehicle's sequence of events cannot be determined.
- iii. **Sequence of Events Codes** - Starting with the vehicle's actions just prior to the first **unstabilized event**, identify chronological events associated with the vehicle. Write the code for the first event in the first block, second in the second block, etc. List up to fifteen events with any additional listed in *Section 9 - Narrative / Statements*. Use the codes listed in *Section 8 - Codes*. For a description of the codes, refer to *Section 8 - Codes* in this manual (page 98).

Example: A vehicle going straight strikes a dog, runs off right side of the road, and strikes a tree. Complete section as follows - find code for going straight ("01. Going Straight") and enter "01" in the first space; find code for striking animal ("33. Collision Inv. Animal") and enter "33" in second space; find code for runs off right side of road ("20. Ran Off Road - Right") and enter "20" in the third space; find code for strikes tree ("36. Collision Inv. Fixed Object") and enter "36" in fourth space.

- iv. **Animal Code(s)** - If sequence of events code "33" (Collision Involving Animal) is marked, a code for the animal involved must be indicated. Enter the appropriate code from the list of animals shown in *Section 8 - Codes*. For a description of the codes, refer to *Section 8 - Codes* in this manual (page 101). List up to four types of animals involved. Animals include both live and dead animals. Do not list the same type of animal code more than once. In the example above, enter "62" (Dog) in the "Animal Code" space.
- v. **Fixed Object Code(s)** - If sequence of events code "36" (Collision Involving Fixed Object) is marked, code(s) for the fixed object(s) must be indicated. Enter the appropriate code identifying the fixed object(s) involved. Identify up to four fixed objects with any additional listed in *Section 9 - Narrative / Statements*. Enter object codes in chronological order as they were involved. Use the codes listed in *Section 8 - Codes*. For a description of the codes, refer to *Section 8 - Codes* in this manual (page 101). In example above, enter "20" (Tree/Stump) in the first "Fixed Object Code" space.

vi. **ALCOHOL USE**

This sub-section indicates whether the driver/operator involved in the crash is suspected to have used alcohol. This is reflective of the investigating officer's opinion of the use (presence) of alcohol, not a judgment of quantity or intoxication. The officer's opinion as to alcohol's contribution to the crash is shown under "Probable Contributing Circumstances."

1. **Yes** - Mark if use of alcohol on the part of the driver/operator is suspected. This must be selected if "Alcohol" is marked under Probable Contributing Circumstances for the driver/operator.
2. **No** - Mark if use of alcohol on the part of the driver/operator is not suspected.
3. **Unknown** - Mark if alcohol use on the part of the driver/operator is unknown.
4. **NA** - Mark if there is no driver.

**7D. PROBABLE CONTRIBUTING CIRCUMSTANCES**

- i. This sub-section is used to record driver errors, vehicle defects, and miscellaneous circumstances that contributed to the crash. Criterion here should not be whether an arrest was made, but that the circumstances existed in the investigator's judgment. Mark an item only if it contributed to the crash and not simply that it existed. Mark all that apply. If "None" or "Unknown" are marked, then no other circumstances can be marked.

7D. PROBABLE CONTRIBUTING CIRCUMSTANCES				<input type="checkbox"/> None
<input type="checkbox"/> Vehicle Defects (Explain)	<input type="checkbox"/> Vision Obstructed	<input type="checkbox"/> Failed To Dim Headlights	<input type="checkbox"/> Improper Towing / Pushing	<input type="checkbox"/> Object / Obstruction in Roadway
<input type="checkbox"/> Speed - Exceeded Limit	<input type="checkbox"/> Driver Fatigue / Asleep	<input type="checkbox"/> Failed To Use Lights	<input type="checkbox"/> Improperly Stopped On Roadway	<input type="checkbox"/> Distracted / Inattentive (Designate Type)
<input type="checkbox"/> Too Fast For Conditions	<input type="checkbox"/> Improper Signal	<input type="checkbox"/> Following Too Close	<input type="checkbox"/> Improper Lane Usage / Change	<input type="checkbox"/> Unknown (Explain)
<input type="checkbox"/> Violation Signal / Sign	<input type="checkbox"/> Improper Backing	<input type="checkbox"/> Wrong Side (Not Passing)	<input type="checkbox"/> Overcorrected	<input type="checkbox"/> Other (Explain)
<input type="checkbox"/> Failed To Yield	<input type="checkbox"/> Improper Turn	<input type="checkbox"/> Wrong Side (One-Way)	<input type="checkbox"/> Improper Riding / Clinging To Veh. Exterior	Distracted / Inattentive CODE(S) <input type="checkbox"/> NA (See Codes in Section 8)
<input type="checkbox"/> Alcohol	<input type="checkbox"/> Improper Passing	<input type="checkbox"/> Physical Impairment (Explain)	<input type="checkbox"/> Failed To Secure Load / Improper Loading	
<input type="checkbox"/> Drugs	<input type="checkbox"/> Improperly Parked	<input type="checkbox"/> Improper Start From Park	<input type="checkbox"/> Animal(s) In Roadway	

1. **None** - Mark only if, in the investigating officer's opinion, there were no probable contributing circumstances. When marked, no other circumstances may be selected.
2. **Vehicle Defects (Explain)** - Mark if vehicle defects contributed to the crash. When marked, include an explanation in *Section 9 - Narrative / Statements*.
3. **Speed - Exceeded Limit** - Mark if the vehicle was exceeding the speed limit.
4. **Too Fast For Conditions** - Mark if the vehicle's speed was too fast for the conditions at the time of the crash. This includes road, weather, and other conditions. When the speed is both over the speed limit and too fast for conditions, mark only *Speed - Exceeded Limit*.
5. **Violation Signal / Sign** - Mark if the driver failed to comply with a traffic signal or sign. Includes electric signal, stop sign, officer / flagman, yield sign, road closed sign, no passing in a work zone, etc.
6. **Failed To Yield** - Mark if the driver failed to yield the right-of-way to another motor vehicle or non-occupant as required.
7. **Alcohol** - Mark when, in the investigating officer's judgment, use of alcohol by the driver contributed to the crash. This does not indicate intoxication, only that alcohol consumption contributed to the crash. "Yes" under "Alcohol Use" (*Section 7C*) must be selected if this is marked.

8. **Drugs** - Mark when, in the investigating officer's judgment, use of drugs (legal or illegal) by the driver contributed to the crash. This does not indicate intoxication only that drug use contributed to the crash.
9. **Vision Obstructed** - Mark if the driver's vision was obstructed and this contributed to the crash. "NA" or "Unknown" cannot be marked under "Vision Obstructed" (in *Section 7A*) if this is marked. Explain in *Section 9: Narrative / Statements*.
10. **Driver Fatigue / Asleep** - Mark if driver fatigue or falling asleep contributed to the crash.
11. **Improper Signal** - Mark if an improper signal by the driver (or no signal when required) contributed to the crash. This includes turn or brake signals, either electronic or hand, but does not include a turn or brake signal failing to operate, which should be shown under "Vehicle Defects" (above).
12. **Improper Backing** - Mark if the driver contributed to the crash by improperly backing the vehicle.
13. **Improper Turn** - Mark if an improper turn on the part of the driver contributed to the crash. A vehicle turning from a straight-only lane would be considered an improper turn. Do not mark in instances where a vehicle is changing from one lane to another, but not turning.
14. **Improper Passing** - Mark if an improper pass (overtaking) of another vehicle going the same direction contributed to the crash.
15. **Improperly Parked** - Mark if the vehicle was improperly parked in a place normally designated for parking or improperly parked along the roadway traffic lanes, such as blocking a [driveway](#), beside a fire hydrant, or in a loading zone. **Note:** Vehicles that are stopped on the roadway, but not "[parked](#)" as defined in the glossary, should be shown as "improperly stopped."
16. **Failed To Dim Headlights** - Mark if the driver's failure to dim the vehicle's headlights contributed to the crash.
17. **Failed To Use Lights** - Mark if the driver's failure to use the vehicle's headlights and/or taillights contributed to the crash.
18. **Following Too Close** - Mark if the driver followed another vehicle too closely and this contributed to the crash.
19. **Wrong Side (Not Passing)** - Mark if the vehicle veered across centerline or was being driven on the wrong side of a two-way street. Does not include driving the wrong way on a one-way street.
20. **Wrong Side (One-Way)** - Mark if the vehicle was being driven the wrong way on a one-way street or highway. For instance, a vehicle traveling eastbound in the westbound lanes of a divided highway.
21. **Physical Impairment (Explain)** - Mark if a physical condition or impairment on the part of the driver contributed to the crash. Includes illness, but does not include fatigue or asleep. Wearing glasses is not considered an impairment. However, not wearing glasses when required is a physical impairment. When marked, explain in *Section 9: Narrative / Statements*.
22. **Improper Start From Park** - Mark if the vehicle was parked and the improper start from the parked position contributed to the crash.

23. **Improper Towing / Pushing** - Mark if the driver was improperly towing or pushing another vehicle and this contributed to the crash.
  24. **Improperly Stopped On Roadway** - Mark if a vehicle in-transport is stopped on a roadway inappropriately or when not directed to do so by a traffic control device or law enforcement officer.
  25. **Improper Lane Usage / Change** - Mark if improper lane usage or an improper lane change contributed to the crash. This does not include instances where the vehicle is making a turning movement. Includes changing lanes and striking another vehicle, going straight in a turn-only lane, etc.
  26. **Overcorrected** - Mark if the driver over-steered in reaction to an event, causing loss of control of the vehicle.
  27. **Improper Riding / Clinging To Veh. Exterior** - Mark if a driver or [occupant](#) of the vehicle was riding or clinging to the vehicle exterior and this contributed to the crash.
  28. **Failed To Secure Load / Improper Loading** - Mark if failure to secure a load on/in the vehicle or improper loading of cargo on/in the vehicle contributed to the crash.
  29. **Animal(s) In Roadway** - Mark if animal(s) in the roadway contributed to the crash. Includes both domestic and wild animals. This includes animals that are alive or dead.
  30. **Object / Obstruction In Roadway** - Mark if an object or obstruction in the roadway contributed to the crash. Includes any item dropped on the roadway from another vehicle, which has come to rest. Also includes trees, dirt, etc. deposited on the roadway.
  31. **Distracted / Inattentive (Designate Type)** - Mark if the driver was distracted or inattentive and it contributed to the crash. **"Distracted / Inattentive Code(s)" must be entered in the appropriate field when this is marked.**

**Note:** "Distracted / Inattentive" only applies to the driver and should not be used as a contributing circumstance on vehicles without a driver. In cases where a non-driver associated with a vehicle was distracted or inattentive, officers should mark "Other" and explain in *Section 9 - Narrative / Statements*.
  32. **Unknown (Explain)** - Mark if it is unknown whether actions on the part of the driver contributed to the crash or if there was not enough evidence at the scene to ascertain who or what contributed. If marked, no other selections can be made. Explain in *Section 9: Narrative / Statements*.
  33. **Other (Explain)** - Mark if another unlisted factor contributed to the crash. Explain in *Section 9: Narrative / Statements*.
- ii. **DISTRACTED / INATTENTIVE CODES** - This identifies the type of distraction(s) involved when "Distracted / Inattentive" is selected as a probable contributing circumstance. Up to four can be entered. Use the codes listed in *Section 8 - Codes*. For a description of the codes, refer to [Section 8 - Codes](#) in this manual (page 107). Explain cause of the distraction or inattention in *Section 9 - Narrative / Statements*.
- NA** - Mark if "Distracted / Inattentive" was not marked as a probable contributing circumstance.

## 7E. WORK ZONE AND TRAFFIC CONTROL



<b>7E. WORK ZONE</b>	<b>TRAFFIC CONTROL</b> <input type="checkbox"/> None <input type="checkbox"/> Unknown	<b>CONTROL MALFUNCTIONING / INOPERATIVE / MISSING</b>
<input type="checkbox"/> Yes <input type="checkbox"/> No <input type="checkbox"/> Unknown	Electric: <input type="checkbox"/> Green/Yellow/Red <input type="checkbox"/> Flashing Red <input type="checkbox"/> Flashing Yellow <input type="checkbox"/> Ramp Meter <input type="checkbox"/> Other (Explain)	<input type="checkbox"/> Yes (Explain) <input type="checkbox"/> No
Workers Present	Other: <input type="checkbox"/> Stop Sign <input type="checkbox"/> No Passing Zone <input type="checkbox"/> Turn Restricted <input type="checkbox"/> Officer / Flagman <input type="checkbox"/> Signal On School Bus	<input type="checkbox"/> Unknown <input type="checkbox"/> NA
<input type="checkbox"/> Yes <input type="checkbox"/> No <input type="checkbox"/> Unknown	Controls: <input type="checkbox"/> Warning Sign / Device <input type="checkbox"/> Railway Crossing Sign / Device <input type="checkbox"/> School Zone <input type="checkbox"/> Yield Sign <input type="checkbox"/> Other (Explain)	

- i. **WORK ZONE** - Mark to indicate if the crash occurred in a **work zone** and, if so, whether workers were present.

A work zone is an area of a **trafficway** where construction, maintenance, or utility work activities are identified by warning signs/signals/indicators, including those on transport devices (e.g., signs, flashing lights, channelizing devices, barriers, pavement markings, flagmen, warning signs and arrow boards mounted on vehicles in a mobile maintenance activity) that mark the beginning and end of a construction, maintenance, or utility work activity.

A work zone extends from the first warning sign, signal, or flashing lights to the END ROAD WORK sign or the last traffic control device pertinent for that work activity.

Work zones also include roadway sections where there is ongoing, moving (mobile) work activity such as lane line painting or roadside mowing only if the beginning of the ongoing, moving (mobile) work activity is designated by warning signs or signals.

1. **Yes** - Mark if the crash occurred in a work zone. If yes, go to "Workers Present" and mark appropriate box.
2. **No** - Mark if the crash did not occur in a work zone.
3. **Unknown** - Mark if it could not be determined if the crash occurred in a work zone.

### Workers Present

Mark only if the crash occurred in a work zone (marked "Yes" above). Leave blank if the crash was not in a work zone or unknown was marked above.

1. **Yes** - Mark if the crash occurred in a work zone and workers were present at the time of the crash.
2. **No** - Mark if the crash occurred in a work zone, but no workers were present at the time of the crash.
3. **Unknown** - Mark if the crash occurred in a work zone and it could not be determined if workers were present at the time of the crash.

Includes (but is not limited to):

- Long-term stationary construction such as building a new bridge, adding travel lanes to the roadway, extending an existing **trafficway**, etc. (construction activity/work).
- Work involving moving activities such as striping the roadway, **median** and roadside grass mowing/landscaping, pothole repair, lane line painting, etc., where there are warning signs or signals marking the beginning of the moving work area (mobile maintenance activity/work).
- Short-term stationary work such as repairing/maintaining electric, gas, water lines, or traffic signals (utility activity/work) where there are warning signs or signals marking the beginning of the work area.

- Areas identified by signage as a work zone where the ongoing work activity has temporarily paused.

Excludes:

- Any private construction, maintenance, or utility work outside the [trafficway](#).
- Any area of the [trafficway](#) where there is moving maintenance activity (e.g., roadside grass mowing/landscaping, pothole repair, snowplowing, lane line painting) without warning signs or signals.
- Citizen removing snow from the [trafficway](#) as a neighborly gesture.
- Private individuals picking up trash road side.

## TRAFFIC CONTROL

1. **None** - Mark if there were no traffic control devices present at the scene at the time of the crash. Mark if a traffic control device is missing, then indicate in *Section 7E - Control Malfunctioning / Inoperative / Missing*.

Mark if a no passing zone (solid yellow line) has been temporarily removed due to roadway resurfacing and has not been replaced.

2. **Unknown** - Mark if the presence of a traffic control device at crash location cannot be determined. Explain in *Section 9 - Narrative / Statements*.

3. **Electric** (Traffic Control Electric Signal)

Electrically powered devices that warn or direct vehicular traffic to take some specific action. Only one can be marked.

- a. **Green / Yellow / Red** - Standard traffic signal (with or without turn arrows), either vertical or horizontal.
- b. **Flashing Red** - Includes either a single flashing red light or when a standard traffic light is set to flashing red.
- c. **Flashing Yellow** - Includes either a single flashing yellow light or when a standard traffic light is set to flashing yellow.
- d. **Ramp Meter** - A traffic signal that controls the entry of vehicles from a [ramp](#) onto a freeway. Ramp meters control the frequency and spacing of merging vehicles. They normally consist of a two-section signal (red and green only). Also known as a ramp control signal. Mark only if the ramp meter was operating at the time of the crash.



(Source: KC Scout)

- e. **Other (Explain)** - Any other traffic control electric signal not listed above. Describe in *Section 9 - Narrative / Statements*.

4. **Other Controls** (Other traffic control)

Mark all that are applicable.

- a. **Stop Sign** - A sign that instructs drivers to stop and then proceed only if the way ahead is clear. Normally is red in color and octagonal (8-sided) with white letters "STOP."
- b. **No Passing Zone** - A section of roadway marked by either a solid yellow line or signs indicating one vehicle should not pass another vehicle going the same direction within that section of roadway.



- c. **Turn Restricted** - Ability of vehicles to turn one direction or another is restricted by signs. Examples include no right turn on red, no left turn, or no U-turn.
- d. **Officer / Flagman** - Movement of traffic is directed by a law enforcement officer or a flagman.
- e. **Signal On School Bus** - A signal and sign on a [school bus](#) directing traffic in its vicinity. Normally consists of a "Stop" sign and red lights that are operated by a school bus driver.
- f. **Warning Sign / Device** - Any sign or device erected to control the flow of traffic or to alert motorists of an upcoming roadway condition.  
  
Examples include curve ahead sign, dip in road, slippery when wet, deer crossing, arrow boards or chevrons in curves, road closed, bump, etc.
- g. **Railway Crossing Sign / Device** - Any sign or device designed to notify drivers of a railway crossing. Includes lights, gate, cross bucks, pavement markings, etc.



- h. **School Zone** - Signs, lights, etc. designating a school zone. The zone is normally the area between two or more signs, lights, etc. designating the beginning and possibly end of such zone.
- i. **Yield Sign** - A sign that indicates that a vehicle driver should prepare to stop if necessary, but does not need to stop if the right-of-way is clear. Normally triangular in shape with letters "YIELD."
- j. **Other (Explain)** - Any other traffic control device, except electric signals, not listed above. Describe in *Section 9 - Narrative / Statements*.

ii. **CONTROL MALFUNCTIONING / INOPERATIVE / MISSING**

- a. **Yes (Explain)** - Mark if one or more of the traffic control devices (electric signals or other) was malfunctioning, inoperative, or missing at the time of the crash. Explain in *Section 9 - Narrative / Statements*. Mark this even if the malfunctioning, inoperative, or missing control was not a contributor to the crash.

**Note:** A standard traffic signal that is flashing red or yellow is not malfunctioning. A standard traffic signal that is dark (no electrical power) with temporary "Stop" signs in place controlling traffic is not malfunctioning.

- b. **Unknown** - Mark if the investigator could not determine if a traffic control device (electric signal or other) was malfunctioning, inoperative, or missing at the time of the crash.
- c. **No** - Mark if the traffic control device(s) listed (electric signals or other) were present and operating correctly at the time of the crash.
- d. **NA** - Mark if this section is not applicable (there was no device present or no device was missing).

**Note:** This should be marked if a no passing zone (solid yellow line) has been temporarily removed and has not been replaced.



*Statements.*

- vii. **TRANSPORT** - Enter one code to indicate whether and how an occupant was transported from the scene to a medical facility for treatment of crash-related injuries. Use the codes listed in *Section 8 - Codes*. For a description of the codes, refer to [Section 8 - Codes](#) in this manual (page 94).

List the name of the transporting agency or person, and medical facility they were transported to in *Section 9 - Narrative / Statements* if applicable.

**Note:** Enter "1" (No) for occupants who are not injured, but transported from the scene to a medical facility for precautionary measures. In addition, enter "1" (No) if a person deceased at the scene is transported. In either case, explain in *Section 9 - Narrative / Statements*.

- viii. **EJECTION** - Enter one code to indicate whether the occupant was ejected from vehicle or if the section is not applicable. Show ejection codes for all types of vehicles, including motorcyclists, bicyclists, and [other transport devices](#). Use the codes listed in *Section 8 - Codes*. For a description of the codes, refer to [Section 8 - Codes](#) in this manual (page 95).

**Note: All Fatality Crashes** - Identify ejection path (windshield, door, t-top, etc.) of **everyone ejected in a fatality crash** in *Section 9 - Narrative / Statements*. This is not applicable for cyclists.

- ix. **AIR BAG** - Enter one code to indicate if air bags were present for the occupant and whether any airbags were deployed. Use the codes listed in *Section 8 - Codes*. For a description of the codes, refer to [Section 8 - Codes](#) in this manual (page 95).
- x. **SAFETY DEVICES** - Enter a maximum of two codes to indicate the type of [safety device\(s\)](#) used, if any, by the occupant. If only one safety device is applicable, then leave the second safety device field blank. Use the codes listed in *Section 8 - Codes*. For a description of the codes, refer to [Section 8 - Codes](#) in this manual (page 97).
- xi. **PHONE NUMBER** - Enter the occupant's telephone number, including the area code.

**7G. COMMERCIAL MOTOR VEHICLE**

<b>7G. COMMERCIAL MOTOR VEHICLE</b> <input type="checkbox"/> NA Required on vehicle if "Yes" was answered to questions in parts 1 and 2 in CMV involvement criteria and vehicle meets one of the three criteria in part 2.									
MOTOR CARRIER IDENTIFICATION (Leasee, etc.) - NAME & ADDRESS (Street, City, State, Zip) <input type="checkbox"/> SAO								PHONE NUMBER <input type="checkbox"/> SAO	
COMMERCIAL / NON-COMMERCIAL		<input type="checkbox"/> Interstate Carrier <input type="checkbox"/> Not In Commerce - Government Vehicle <input type="checkbox"/> Not In Commerce - Other Vehicle		MC / MX / ICC NO.		USDOT NO.			
<input type="checkbox"/> Intrastate Carrier <input type="checkbox"/> Not In Commerce - Rental Vehicle									
CARGO BODY TYPE									
<input type="checkbox"/> Enclosed Box <input type="checkbox"/> Flatbed <input type="checkbox"/> Concrete Mixer <input type="checkbox"/> Garbage / Refuse <input type="checkbox"/> Pole Trailer <input type="checkbox"/> Vehicle Towing <input type="checkbox"/> Intermodal Container Chassis		<input type="checkbox"/> Cargo Tank <input type="checkbox"/> Dump <input type="checkbox"/> Auto Transporter <input type="checkbox"/> Grain / Chip / Gravel <input type="checkbox"/> Log		<input type="checkbox"/> Another Veh.		<input type="checkbox"/> NA (No Cargo Body) <input type="checkbox"/> Other		<input type="checkbox"/> Unknown	
HAZARDOUS MATERIALS		PLACARD DISPLAYED <input type="checkbox"/> Yes <input type="checkbox"/> No <input type="checkbox"/> Unknown		4-DIGIT NO.		CLASS		HAZARDOUS MATERIAL NAME	
				HM CARGO PRESENT <input type="checkbox"/> Yes <input type="checkbox"/> No <input type="checkbox"/> Unknown		HM CARGO RELEASED <input type="checkbox"/> Yes <input type="checkbox"/> No <input type="checkbox"/> Unknown			

Completion of this section is required if "Yes" was answered to questions in parts 1 and 2 in the CMV involvement criteria in *Section 1 - General Crash Information*.

- i. **NA**

If "No" was answered to either part 1 or part 2 in the CMV involvement criteria in *Section 1 - General Crash Information*, mark "NA" for all vehicles.

**Note:** If "Yes" was answered to both parts 1 and 2 in the CMV involvement criteria in *Section 1 - General Crash Information*, mark "NA" for all vehicles that **do not meet the**

**CMV criteria.**

ii. **MOTOR CARRIER IDENTIFICATION (LEASEE, ETC.)**

A valuable tool to identify the carrier via the Internet is the [SAFER web site](http://safersys.org/CompanySnapshot.aspx). (<http://safersys.org/CompanySnapshot.aspx>). The "Company Snapshot" will allow you to cross-reference the USDOT and MC / MX numbers and carrier's name or identify the appropriate identification number(s) using the carrier's name. Some companies have the same name. Make sure when searching SAFER by carrier name that the correct carrier is selected. Refer to Appendix D, page 134 for instructions on accessing and using the SAFER web site.

1. **Name & Address (Street, City, State, Zip)** - Enter the name of the [motor carrier](#) and the carrier's principle place of business address.

Refer to [Appendix D](#) page 134 for instructions concerning how to properly identify the motor carrier and how to access carrier information. Make certain the USDOT and/or MC/MX/ICC number match the carrier name.

Note reference addresses: A nationwide company may have a local terminal address; however, use the corporate headquarters business address.

**SAO** - (Same as Owner) Mark if the owner's name, motor carrier name, and address are the same. No further information is needed in this field if this is marked.

2. **Phone Number** - Enter the motor carrier's telephone number, including area code.

**SAO** - (Same as Owner) Mark if the owner's telephone number and the motor carrier's telephone number are the same. No further information is needed in this field if this is marked.

3. **Commercial / Non-commercial**

- a. **Interstate Carrier** - Any carrier where transit between the points of origin and termination does not occur entirely within the borders of the state of origin.

Includes (but is not limited to):

- Transit between a place in a state and a place outside of such state (including a place outside of the U.S.)
- Transit between two places in a state through another state or place outside of the U.S.
- Transit between two places in a state as part of trade, traffic, or transportation originating or terminating outside the state or U.S.

Excludes:

- [Intrastate commerce](#)

- b. **Intrastate Carrier** - Any carrier where transit between the points of origin and termination occurs entirely within the borders of the state of origin.

- c. **Not In Commerce - Government Vehicle** - Any government vehicle not operating [in commerce](#) whether it is operated by the local, state, or federal government.

- d. **Not In Commerce - Rental Vehicle** - Includes rental vehicles (e.g., Uhaul, Ryder, Penske) that qualify by size (over 10,000 pounds [GVWR/GCVWR](#)) that are operated by a private individual and not [in](#)

commerce.

- e. **Not In Commerce - Other Vehicle** - Includes personal vehicles that qualify by size (over 10,000 pounds [GVWR/GCVWR](#)) that are operated by a private individual and not [in commerce](#).
- 4. **MC / MX / ICC No.** - Enter the carrier's MC / MX number. The MC / MX number is formerly known as the ICC number. The number is assigned to each carrier by the Federal Motor Carrier Safety Administration for motor carrier identification. Refer to [Appendix D](#), page 134 for instructions concerning how to properly identify the motor carrier and how to access carrier information. Make certain the MC / MX number matches the carrier name. If there is no MC / MX number identified, enter "none" in this field.
- 5. **USDOT No.** - Enter the carrier's USDOT number. The USDOT number is the primary number assigned to interstate and intrastate carriers by the Federal Motor Carrier Safety Administration for motor carrier identification. Refer to [Appendix D](#), page 134 for instructions concerning how to properly identify the motor carrier and how to access carrier information. Make certain the USDOT number matches the carrier name. If there is no USDOT number, enter "none" in this field.
- 6. **Cargo Body Type** - Mark the appropriate box to indicate the commercial motor vehicle (CMV) cargo body type. Mark only one box.

(Source of illustrations: FMCSA)

a. **Enclosed Box** -



b. **Cargo Tank** -



c. **Flatbed** -

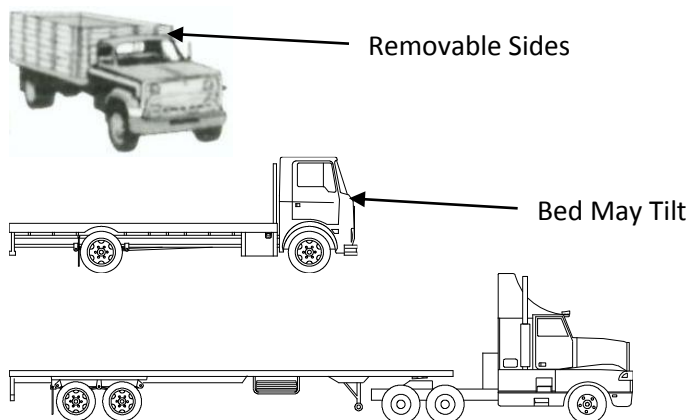

d. **Dump** -





e. **Concrete Mixer -**



f. **Auto Transporter -**



g. **Garbage / Refuse -**



h. **Grain / Chip / Gravel -**



i. **Pole Trailer -**

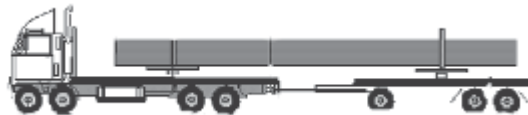

j. **Log -**



k. **Vehicle Towing Another Veh. -**



l. **Intermodal Container Chassis -**



m. **NA (No Cargo Body)** -

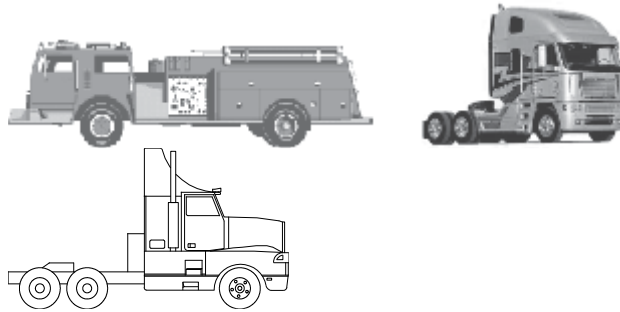

n. **Other** - Mark if the CMV has a cargo body type other than those shown above.

o. **Unknown** - Mark if it cannot be determined what cargo body type the CMV had.

## 7. Hazardous Materials

### a. Placard Displayed

i. **Yes** - Mark if the vehicle is displaying a hazardous material placard.

ii. **No** - Mark if the vehicle is not displaying a hazardous material placard.

iii. **Unknown** - Mark if it cannot be determined if the vehicle was displaying a hazardous material placard at the time of the crash.

b. **4-Digit No.** - Enter the four-digit hazardous materials number found in the middle of the placard, if applicable. (See example below). The number should be located on vehicles transporting hazardous materials in tank cars, cargo tanks, portable tanks, enclosed vans, open vans, or other containers. If more than one placard is displayed, enter the information from only one. The placard information entered must correspond with the information entered into the Hazardous Materials Name field (described below).

Enter "NA" if no placard is displayed.

**Note:** Some placards will not have a 4-Digit number and/or a Class number. In these cases, enter "N/A" in each of the respective fields.



- c. **Class** - Enter the number found on the bottom of the diamond placard, if applicable. (See examples above and below). If more than one placard is displayed, enter the information from only one. The placard information entered must correspond with the information entered into the Hazardous Materials Name field (described below).

Enter "NA" if no placard is displayed.

**Note:** Some placards will not have a 4-Digit number and/or a Class number. In these cases, enter "N/A" in each of the respective fields.

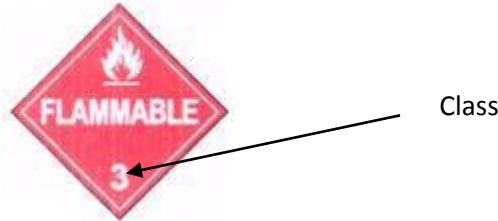

- d. **HM Cargo Present** (Hazardous Materials Cargo Present)

The shipping papers or manifest identify the type of hazardous materials being transported. See [Appendix D](#), page 135 for guidelines to determine the presence of hazardous materials using shipping papers.

- iv. **Yes** - Mark if the vehicle is transporting hazardous material(s). An empty hazardous material cargo tank that has not been cleaned and purged is still considered to be transporting hazardous materials.
- v. **No** - Mark if the vehicle is not transporting hazardous material(s).
- vi. **Unknown** - Mark if it cannot be determined if the vehicle was transporting hazardous materials at the time of the crash

- e. **HM Cargo Released** (Hazardous Materials Cargo Released)

- vii. **Yes** - Mark if hazardous material cargo was present and it was released due to [damage](#) sustained during the crash.

**Note:** Leakage of fuel or oil carried by the vehicle for its own use DOES NOT qualify.

- viii. **No** - Mark if hazardous material was not released due to the crash.
- ix. **Unknown** - Mark if it cannot be determined if a hazardous material was released due to the crash.

- f. **Hazardous Material Name** - Enter the appropriate hazardous material name as shown on the shipping papers/manifest. Complete this field, even if a hazardous material is being transported and no placard is displayed. See [Appendix D](#), page 135 for guidelines to identify hazardous materials using shipping papers.

**Note:** An empty hazardous material cargo tank that has not been cleaned and purged is still considered to be transporting hazardous

materials. Therefore, the name of the material should be entered in this field.

## VIII. SECTION 8 - CODES

- a. **SEAT LOCATION** - Enter one of the following codes to indicate seat location for each person in / on the vehicle, cycle, or train.

SEAT LOCATION	FR	SR	TR
XX - Not Known	FC	SC	TC
B - Pedalcycle	FL	SL	TL
M - Motorcycle			
CP - Commercial Passenger			
OE - Occupant - Enclosed Load Area			
OU - Occupant - Unenclosed Load Area			
RC - Rail Crew			
SV - Other (Explain in Narrative)			
NA - Not Applicable			

**FR, FC, FL** - Shows seat location of driver / other front row occupants in passenger vehicles and trucks. An explanation should be provided in *Section 9 - Narrative / Statements* when a driver is not shown seated in the Front-Left (FL) seat.

**Note:** Enter "FL" for the seating position for a person riding (straddling) and controlling an animal such as a horse or operating a farm tractor. Seating positions for other passengers on an animal, or farm tractor should be shown as "SV".

**SR, SC, SL** - Shows seat location of second row occupants in passenger vehicles and trucks.

**TR, TC, TL** - Shows seat location of third row occupants in passenger vehicles and trucks.

**Note:** Show actual seat locations for drivers / occupants of all terrain vehicles that are not straddled.

**XX** - Shows undetermined seat location.

**B** - Shows seat location of bicycle and [pedalcycle](#) drivers.

**M** - Shows seat location of drivers of motorcycles, motorized bicycles, and all terrain vehicles the driver has to straddle.

**CP** - Shows occupants, other than the driver or rail crew member, on commercial passenger-carrying vehicles, i.e., bus, [school bus](#), train, etc.

**Note:** Use actual seat locations (FL, FR, FC, etc.) for commercial passenger carrying vehicles with three or less standard configuration seating areas, i.e, taxi and van.

**OE** - Shows location of occupants riding in **enclosed** cargo / bed area of vehicle.

**OU** - Shows location of occupants riding in **unenclosed** (open) cargo / bed area of vehicle.

**RC** - Use this code to show the seat location of a member of a train crew (i.e., engineer, conductor). Train passengers are shown as "CP".

**Note:** Use actual seat locations (FL, FR, FC, etc.) for rail maintenance vehicles (pickups, heavy duty trucks, etc.) with retractable flange wheels, which can be operated either on rails or a roadway.

**SV** - Shows seat location of occupants:

- In fourth and subsequent rows in non-commercial passenger vehicles, i.e., van, etc.
- Riding on any part of a vehicle not specifically addressed in this section.
- When the motor vehicle is so constructed that it does not fit the normal arrangement for identifying seat positions of occupants other than the driver.
- Passengers on motorcycles, bicycles, and [pedalcycles](#).

**NA** - This is only used when there is no driver or engineer and only applies to driver / engineer information. Do not use for [pedestrian](#) or occupant information.

**Notes:**

- When one [occupant](#) is sitting on another occupant's lap, enter the same seat location code for both and explain in *Section 9 - Narrative and Statements*.
  - Identify the driver's seat location on every vehicle or [other transport device](#), if known. Do not use "SV" or "CP" for a driver.
  - A person sitting in the driver's seat of a "[Parked Motor Vehicle](#)" is shown as an occupant, not a driver. The information pertaining to this person is shown in *Section 7F - Occupants*.
- b. **INJURY** - Enter one of the following codes to indicate [injury](#) information for each person involved in the crash if the injury was a direct result of the crash. Injuries not sustained as a direct result of the crash should not be codified in this field; however, they should be noted in *Section 9 - Narrative / Statements*.

INJURY	
1.	Fatal
2.	Suspected Serious Injury
3.	Evident - Not Disabling
4.	Probable - Not Apparent
5.	None Apparent
U.	Unknown
N.	NA

**Note:** According to ANSI D16.1, a person is any living human. Within the context of this manual and for crash reporting purposes, a fetus is considered to be part of a pregnant woman rather than a separate individual. If a fetus is delivered alive during the [unstabilized event](#), it is considered a person involved in the crash and counted as such.

1. **Fatal** - The person was dead or dies within 30 days ([late death](#)) of the crash date from crash related injuries.
2. **Suspected Serious Injury** - A suspected serious injury is any injury other than fatal which results in one or more of the following:
  - Severe laceration resulting in exposure of underlying tissues/muscle/organs or resulting in significant loss of blood
  - Broken or distorted extremity (arm or leg)
  - Crush injuries
  - Suspected skull, chest or abdominal injury other than bruises or minor lacerations
  - Significant burns (second and third degree burns over 10% or more of the body)
  - Unconsciousness when taken from the crash scene

- Paralysis

3. **Evident - Not Disabling** - When observed at the scene, the person sustained visible injuries that were neither fatal nor disabling.

Includes (but is not limited to):

- Momentary unconsciousness
- Lump on head
- Abrasions
- Bruises
- Minor lacerations

4. **Probable - Not Apparent** - Any **injury** claimed at the scene, but not visible. The investigating officer has no medical competency to deny the existence of claimed injuries.

5. **None Apparent** - No apparent or claimed injury at the scene.

U. **Unknown** - Injuries could not be determined, e.g., the person left the scene or is unavailable for questioning.

N. **NA** - This is only used when there is no driver or railway engineer and only applies to driver / engineer information. Do not use for **pedestrian** or **occupant** information.

c. **TRANSPORTED (For Medical Treatment)** - Enter one of the following codes for each person involved in the crash indicating whether and how they were transported from the scene to a medical facility for treatment of crash-related injuries. For any person transported to a medical facility, list the name of the transporting agency or person, and the medical facility in *Section 9 - Narrative / Statements*.

**Note:** Enter "1" (No) for a person who is not injured and is transported from the scene to a medical facility for precautionary measures. In addition, enter "1" (No) if a person deceased at the scene is transported. In either case, explain in *Section 9 - Narrative / Statements*.

<p><b>TRANSPORTED</b> (For Medical Treatment)</p> <p>1. No 2. EMS 3. Other U. Unknown N. NA</p>
---

1. **No** - The person was not transported from the scene for medical treatment.

2. **EMS** - The person was transported from the scene by ambulance / other emergency medical service vehicle / aircraft.

3. **Other** - The person was transported by any means other than EMS.

U. **Unknown** - Transportation from the scene for medical treatment is unknown.

N. **NA** - This is only used when there is no driver or railway engineer and only applies to driver / engineer information. Do not use for **pedestrian** or **occupant** transport information.

- d. **EJECTION** - - Enter one of the following codes to indicate ejection information for each person in / on the vehicle, cycle, or [other transport device](#).

EJECTION	
1.	NA
2.	No
3.	Partially
4.	Totally
U.	Unknown

**Note: All Fatality Crashes** - Identify ejection path (windshield, door, t-top, etc.) of **everyone ejected in a fatality crash** in *Section 9 - Narrative / Statements*. This is not applicable for cyclists.

1. **NA** - This is only used when there is no driver or railway engineer and only applies to driver / engineer information.
2. **No** - Person was not ejected from the vehicle.
3. **Partially** - Person was partially ejected from the vehicle.
4. **Totally** - Person was totally ejected from the vehicle.
- U. **Unknown** - It is unknown whether the person was ejected from the vehicle.

- e. **AIR BAG** - Enter one of the following codes to indicate air bag information for each person in / on the vehicle, motorcycle, or [other transport device](#). Air bag codes refer to the seated position of listed occupants, not the overall deployment of the device within the vehicle.

AIR BAG	
1. None / NA	9. Deployed -
3. Not Deployed	Combination
4. Removed	10. Deployment
5. Deployed - Front	Unknown
6. Deployed - Side	U. Air Bag Presence
7. Deployed - Curtain	Unknown
8. Deployed - Other (Knee, Air Belt, etc.)	

(Source of photographs / illustration: MMUCC)

1. **None / NA** - The vehicle is not equipped with any airbags or the entire category is not applicable (cyclist, animal being ridden, animal drawn vehicle, etc.).
2. (Historical code - No longer used)
3. **Not Deployed** - The vehicle is equipped with an airbag(s), but they did not deploy.
4. **Removed** - The vehicle was equipped with an airbag(s); however, one or more have been removed. Also includes airbags that have previously deployed and have not

been replaced.

5. **Deployed - Front** - Only a front airbag on the vehicle was deployed during the crash. Includes driver and/or passenger front airbags.



6. **Deployed - Side** - Only side airbag(s) on the vehicle were deployed during the crash.



7. **Deployed - Curtain** - Only curtain airbag(s) on the vehicle were deployed during the crash.



8. **Deployed - Other (knee, air belt, etc.)** - Only airbag(s) other than front, side, or curtain were deployed during the crash.

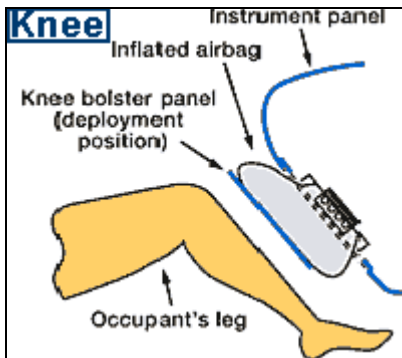

9. **Deployed - Combination** - A combination of airbags was deployed during the crash. If only a multiple number of the same type of airbag is deployed, mark that type of airbag. For example, if both front airbags are deployed, use "5" above and not "9". Explain in *Section 9 - Narrative and Statements*.





10. **Deployment Unknown** - Deployment of airbags during the crash is unknown.

U. **Air Bag Presence Unknown** - It cannot be determined if the vehicle was equipped with an air bag(s).

f. **SAFETY DEVICES** - Enter one or two of the following codes to indicate **safety device(s)** used by each driver, **occupant**, or pedestrian. If only one safety device is applicable, then leave the second safety device field blank.

SAFETY DEVICES	
1. None	10. Booster Seat
2. Not Used	11. Child Restraint - Forward Facing
3. Shoulder Belt Only	12. Child Restraint - Rear Facing
4. Lap Belt Only	13. Other Helmet
5. Shoulder and Lap Belt	14. Reflective Clothing
7. DOT Compliant MC Helmet	15. Other
8. No Helmet	U. Use Unknown
	N. Not Applicable

**Examples:**

SAFETY DEVICES		SAFETY DEVICES		SAFETY DEVICES	
5		11		13	14

1. **None** - Mark if the vehicle was not equipped with seatbelts for the driver or occupant seat location.
2. **Not Used** - Mark if the vehicle was equipped with seatbelts; belts were not in use by the driver or occupant at the time of the crash.

Mark if a pedestrian was not wearing reflective clothing or any other type of safety device.

3. **Shoulder Belt Only** - Mark if the vehicle was equipped with seat belts; only the shoulder belt was in use by the driver or occupant at the time of the crash.
4. **Lap Belt Only** - Mark if the vehicle was equipped with seat belts; only the lap belt was in use by the driver or occupant at the time of the crash.
5. **Shoulder and Lap Belt** - Mark if the vehicle was equipped with seat belts; both shoulder and lap belts were in use by the driver or occupant at the time of the crash.
6. (Historical code - No longer used)
7. **DOT Compliant MC Helmet** - Mark if the driver or occupant of a cycle or ATV was wearing a Department of Transportation (DOT) compliant motorcycle helmet. Helmets that are not DOT compliant should be marked as "13. Other Helmet" (below).

This applies to helmets that are compliant with Federal Motor Vehicle Safety Standards, typically weigh approximately 3 pounds, have an inner liner at least one-inch thick of firm polystyrene foam, have an inside label that states the manufacturer, model, and date of manufacture, and have a DOT sticker on the back of the helmet. A DOT sticker alone is not sufficient evidence to indicate that the helmet is DOT compliant, as counterfeit stickers have been found affixed to

non-compliant helmets.

8. **No Helmet** - Mark if driver or occupant of a cycle or ATV was not wearing a helmet.
  9. (Historical code - No longer used)
  10. **Booster Seat** - Mark if the occupant was properly belted in a booster seat at the time of the crash.
  11. **Child Restraint - Forward Facing** - Mark if the occupant was properly belted in a forward facing child restraint device at the time of the crash.
  12. **Child Restraint - Rear Facing** - Mark if the occupant was properly belted in a rear facing child restraint device at the time of the crash.
  13. **Other Helmet** - Mark if the driver or occupant of a cycle, ATV, or **personal conveyance** was wearing a non-DOT compliant helmet.
  14. **Reflective Clothing** - Mark if the driver or occupant of a cycle, ATV, or **personal conveyance**, or pedestrian was wearing reflective clothing. Describe in *Section 9 - Narrative / Statements*.
  15. **Other** - Mark if the driver or occupant was using a **safety device** not listed above.
- U. **Use Unknown** - Mark if use of safety equipment could not be determined.
- N. **Not Applicable** - Mark if there was no driver. This is only used when there is no driver or railway engineer and only applies to driver / engineer information. Do not use for pedestrian or occupant safety device information.

g. **VEHICLE ACTION / SEQUENCE OF EVENTS -**

VEHICLE ACTION / SEQUENCE OF EVENTS (Items with double-asterisk [**] require additional coding)			
1. Going Straight	10. Start From Parked	19. Airborne	28. Separation Of Units
2. Overtaking	11. Backing	20. Ran Off Roadway - Right	29. Returned To Roadway
3. Making Right Turn	12. Stopped In Traffic	21. Ran Off Roadway - Left	30. Collision Inv. Pedestrian
4. Right Turn on Red	13. Parked	22. Overturn / Rollover	31. Collision Inv. Bicycle/Pedalcycle
5. Making Left Turn	14. Changing Lanes	23. Fire / Explosion	32. Collision Inv. Railway Veh.
6. Making U-Turn	15. Avoiding	24. Immersion	33. Collision Inv. Animal (**)
7. Skidding / Sliding	16. Cross Median	25. Jackknife	34. Collision Inv. MV in Transport
8. Slowing / Stopping	17. Cross Center Of Road	26. Cargo Loss / Shift	35. Collision Inv. Parked MV
9. Start In Traffic	18. Cross Road	27. Equipment Failure	36. Collision Inv. Fixed Object (**)
			37. Collision Inv. Other Object (Explain)
			38. Other Non-collision
			39. Collision Inv. Bicycle/Pedalcycle
			40. Collision Inv. Animal Drawn Vehicle / Animal Ridden For Transportation
			41. Collision Inv. Working MV
			42. Downhill Runaway
			43. Fell/Jumped From MV
			44. Thrown/Falling Object
			45. Struck By Falling, Shifting Cargo, Object Set In Motion By Own MV
			46. Ran Off Roadway - Other (Explain)
			47. Cross Separator

1. **Going Straight** - The vehicle was going straight.
2. **Overtaking** - The vehicle was passing another vehicle traveling the same direction.
3. **Making Right Turn** - The vehicle was making a right turn.
4. **Right Turn on Red** - The vehicle was making a right turn while controlled by a red traffic signal.
5. **Making Left Turn** - The vehicle was making a left turn.
6. **Making U-Turn** - The vehicle was making a U-turn.
7. **Skidding / Sliding** - The vehicle was skidding or sliding.
8. **Slowing / Stopping** - The vehicle was slowing or stopping.
9. **Start in Traffic** - The vehicle was starting (from being stopped) in traffic.

10. **Start From Parked** - The vehicle was starting from being parked.
11. **Backing** - The vehicle was backing up.
12. **Stopped in Traffic** - The vehicle was stopped in traffic (not parked).
13. **Parked** - The vehicle was parked. See definition of [Parked Motor Vehicle](#) in the *Glossary* on page 20.
14. **Changing Lanes** - The vehicle was changing lanes, such as moving from one lane to another while going the same direction, moving from a straight ahead lane into a turn lane, drifting from one lane into another lane going the same direction, etc.
15. **Avoiding** - Driver was avoiding an object, other vehicle, animal, etc. When marked, explain what was being avoided in *Section 9 - Narrative / Statements*.
16. **Cross Median** - The vehicle traveled completely across the [median](#). The vehicle must come into contact with the opposing road.
17. **Cross Center of Road** - All, or a portion (mirrors, cargo, etc.), of the vehicle traveled across the center of the road into an opposing lane.
18. **Cross Road** - The vehicle was crossing the road from another road, private road, etc.
  - Includes (but is not limited to):
    - Vehicle crossing a road from another road at an [intersection](#).
    - Vehicle out of control crosses an opposing road.
  - Excludes (but is not limited to):
    - Vehicle running off the road and crossing a private drive.
    - Vehicle running off the road, overcorrecting, and crossing the same road.
19. **Airborne** - The vehicle became airborne.
20. **Ran Off Roadway - Right** - The vehicle ran off the right side of the roadway. Example: The vehicle ran across the outside (right) fog line and onto the right [shoulder](#).
21. **Ran Off Roadway - Left** - The vehicle ran off the left side of the roadway. Example: The vehicle ran across the inside (left) fog line and onto the left [shoulder](#).
22. **Overturn / Rollover** - The vehicle overturned at least 90 degrees.
23. **Fire / Explosion** - The vehicle caught on fire or exploded.
24. **Immersion** - The vehicle became immersed into a liquid.
25. **Jackknife** - Unintended contact between any two units of the same multi-unit road vehicle; such as a truck-trailer combination.
26. **Cargo Loss / Shift** - The loss or shift of items carried on or in a motor vehicle or its trailing unit. [Occupants](#) are not considered cargo. **Does not apply to snow or ice coming off of the vehicle.**
27. **Equipment Failure** - Failure of the vehicle's parts or equipment.

28. **Separation of Units** - The separation of the power and towed units or separation of towed units.
29. **Returned to Roadway** - The vehicle returned to the roadway after running off of the same roadway.
30. **Collision Inv. Pedestrian** - Collision of the vehicle with a pedestrian.
31. **Collision Inv. Bicycle/Pedalcycle** - Collision of the vehicle with a bicycle or [pedalcycle](#).
32. **Collision Inv. Railway Veh.** - Collision of the vehicle with a [railway vehicle](#).
33. **Collision Inv. Animal** - Collision of the vehicle with an animal. If marked, indicate the type of animal under *Animal Codes* in *Section 7*.  
  
An animal being used for transportation purposes is considered an "Animal Drawn Veh / Animal Ridden Trans."
34. **Collision Inv. MV in Transport** - Collision of the vehicle with a [motor vehicle in transport](#).
35. **Collision Inv. Parked MV** - Collision of the vehicle with a [parked motor vehicle](#).
36. **Collision Inv. Fixed Object** - Collision of the vehicle with a [fixed object](#). If marked, indicate the fixed object(s) struck under *Fixed Object Code(s)* in *Section 7*. See definition of [Fixed Object](#) in the glossary.
37. **Collision Inv. Other Object (Explain)** - Collision of the vehicle with some other non-fixed object.
38. **Other Non-collision** - The code should be used for non-collision crashes where no other non-collision code is applicable.
39. **Collision Inv. Bicycle / Pedalcycle in Bicycle Lane** - Collision of the vehicle with a bicycle or [pedalcycle](#) in a designated bicycle lane.
40. **Collision Inv. Animal Drawn Vehicle / Animal Ridden for Transportation** - Collision of the vehicle with an animal drawn vehicle or an animal being ridden for transportation.
41. **Collision Inv. Working MV** - Collision of the vehicle with a [working motor vehicle](#).
42. **Downhill Runaway** - A downhill runaway of the vehicle.
43. **Fell / Jumped From MV** - An individual fell or jumped from a motor vehicle.
44. **Thrown / Falling Object** - The vehicle was struck by a thrown or falling object. This includes objects set in motion by another vehicle.
45. **Struck By Falling, Shifting Cargo, Object Set in Motion by own MV** - The vehicle was struck by its own falling or shifting cargo, or by an object set in motion by the same vehicle.
46. **Ran Off Roadway - Other (Explain)** - This is used when the vehicle ran off the roadway and "Ran Off Roadway - Right" or "Ran Off Roadway - Left" are not applicable. Explain in *Section 9 - Narrative and Statements*. For example, when a vehicle proceeds through a "T" [intersection](#) and off the roadway. See example in [Appendix E](#), page 147.

47. **Cross Separator** - The vehicle traveled completely across the separator. The vehicle must come into contact with the opposing road. See definition of "separator" in the glossary.

**h. ANIMAL CODES FOR VEHICLE ACTION / SEQUENCE OF EVENTS**

ANIMAL CODES FOR VEHICLE ACTION / SEQUENCE OF EVENTS				
60. Deer	61. Farm Animal	62. Dog	63. Other Animal	U. Unknown

60. **Deer** - Includes deer only.
61. **Farm Animal** - Includes domesticated animals such as a cow, pig, horse, etc.
62. **Dog** - Includes domesticated dogs only.
63. **Other Animal** - Includes all other animals that do not fall into the previous categories. This includes all wild animals (except deer).
- U. **Unknown** - The investigator has determined that an animal was struck; however, the type of animal cannot be determined.

**i. FIXED OBJECT CODES FOR VEHICLE ACTION / SEQUENCE OF EVENTS**

FIXED OBJECT CODES FOR VEHICLE ACTION / SEQUENCE OF EVENTS				
20. Tree / Stump (Standing)	26. Culvert	32. Building	38. Bridge Rail	44. Wall
21. Embankment / Driveway / Ground / Rock Bluff	27. Highway Traffic Sign Post / Support	33. Traffic Signal Support	39. Guardrail End	45. Cable Barrier
22. Guardrail Face	28. Bridge Pier / Abutment / Support	34. Impact Attenuator / Crash Cushion	40. Other Traffic Barrier	46. Bridge Overhead Structure
23. Utility Pole	29. Curb	35. Fire Hydrant	41. Overhead Sign Support	47. Overhead Line / Cable
24. Fence	30. Mail Box	36. Other (Explain)	42. Ditch	U. Unknown
25. Street Light Support	31. Concrete Traffic Barrier	37. Bridge Parapet End	43. Other Post / Pole / Support	

20. **Tree / Stump (Standing)** - Use this only if the tree or stump is standing. Otherwise, it is considered an "Other Object."
21. **Embankment / Driveway / Ground / Rock Bluff** - An embankment is a raised structure to hold back water, to carry or support a roadway, or the result of excavation or washout that may be faced with earth, rock, stone, or concrete.
22. **Guardrail Face** - Areas along a guardrail stretch other than the ends.

A low barrier running along the edge of the road shoulder either on the right or the left and which has primary longitudinal structure composed of metal (plates, cable, mesh, box beam, etc.). Guardrails which serve as bridge rails should be marked as "bridge rail."



23. **Utility pole** - Constructed for the primary function of supporting an electric line, telephone line, or other electrical-electronic transmission line or cable. It may have lights attached also.

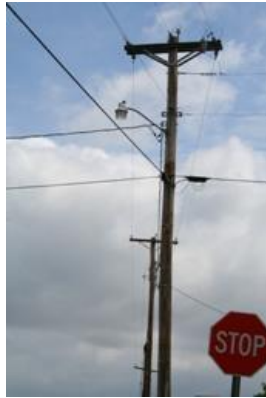

24. **Fence** - A fence can be made of wood, chain link, stone, wire, PVC, etc.; however, does not include shrub hedges serving as containment for property. A "wall" that is part of a fence structure is considered a "fence."
25. **Street light support** - Support poles for roadway lighting. "Utility Pole" should be marked if lines are attached other than power for the light itself.

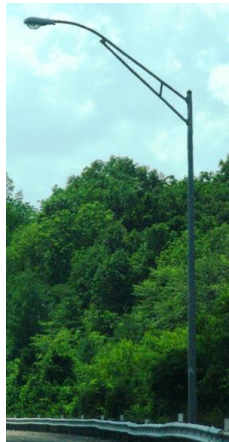

26. **Culvert** - An enclosed structure providing free passage under a roadway with a clear opening of less than twenty feet in width. If the distance is greater than twenty feet, the structure is considered a bridge.
27. **Highway Traffic Sign Post / Support** - A vertical pole, post, or other type of support for a traffic sign.



Highway Traffic Sign Post / Support

28. **Bridge Pier / Abutment / Support** - Support for a bridge structure including the ends.

A bridge pier is a square or round column of stone, concrete, brick, steel, or wood supporting a bridge between abutments.



A bridge abutment is a wall supporting the ends of a bridge generally retaining or supporting the embankment under bridge ends and composed of stone, concrete, brick, or wood (includes wing walls).

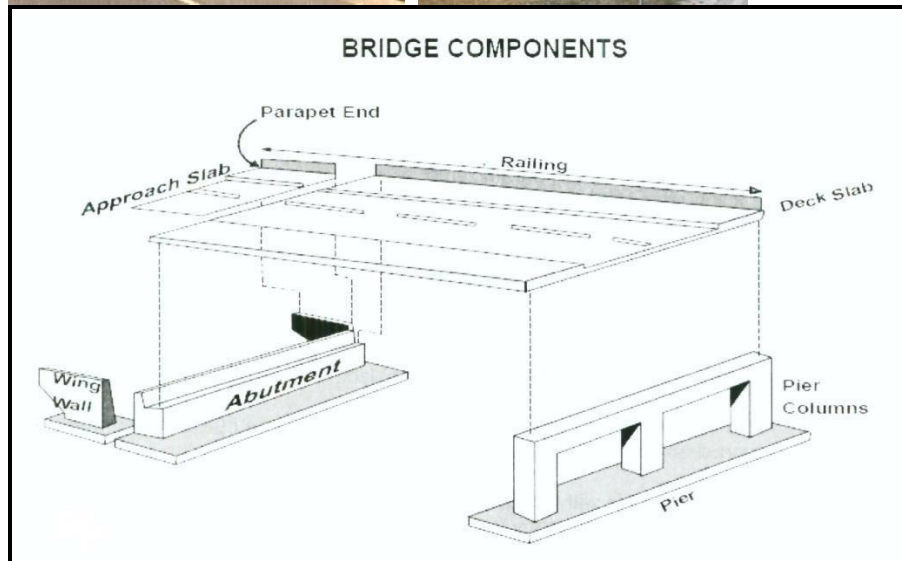

29. **Curb** - A structure composed of concrete, asphalt, brick, etc. that is up to twelve inches in height which borders the roadway, provides drainage control and pavement edge delineation. The face of the curb may be sloped or vertical.



30. **Mailbox** - A public or private box for the collection/delivery of mail. (Dictionary)

31. **Concrete Traffic Barrier** - Longitudinal traffic barriers constructed of concrete and located on the outside of the road surface, in a [median](#), or in gore areas. This

includes all temporary concrete barriers regardless of location (e.g., temporary barrier on a bridge being used to control traffic during bridge repair construction).



- 32. **Building** - A roofed structure for permanent use. (e.g., house, toll booth, pole barn).
- 33. **Traffic Signal Support** - A pole, post, or other type of support for a traffic signal. Does not include [work zone](#) traffic control devices.



- 34. **Impact Attenuator / Crash Cushion** - A device for controlling the absorption of energy released during a vehicle collision ("crash cushions"). Its most common application involves protection of fixed roadside objects such as bridge piers, elevated gores at exit [ramps](#), etc. Examples include, but are not limited to, barrels filled with water or sand, plastic collapsible structures, collapsible guard rail ends, etc.



- 35. **Fire Hydrant** - A device used to provide water for fire protection.
- 36. **Other** - Includes all other fixed objects not listed.
- 37. **Bridge Parapet End** - The end of a low wall which runs along the outermost edge of the roadway or sidewalk on the bridge and usually composed of brick, stone, or concrete. Includes the unprotected end of bridge rail. Does not include any guardrail or [impact attenuator/crash cushion](#) attached to the parapet end.



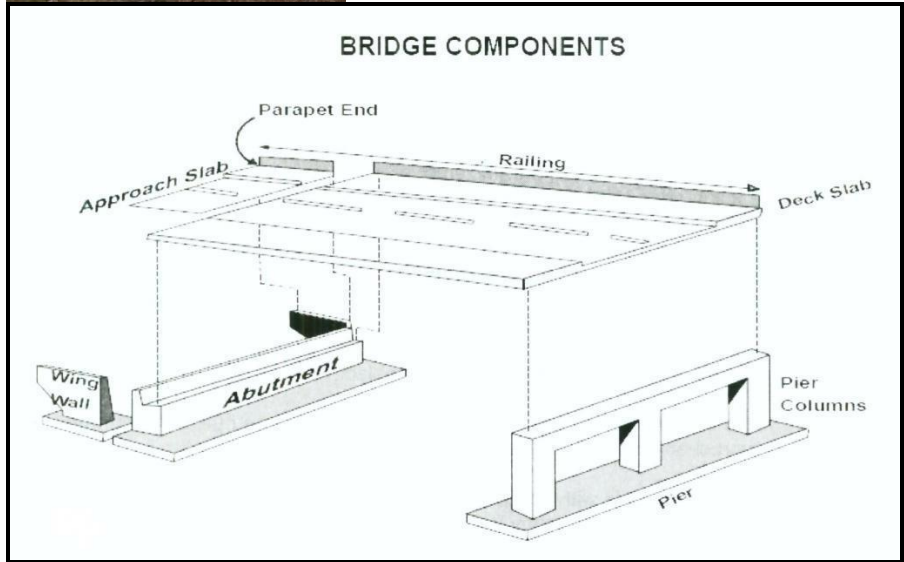

38. **Bridge Rail** - A [bridge parapet](#) or a barrier attached to a bridge deck to restrain motor vehicles, pedestrians, or other users. This includes guardrails which serve as bridge rails.



39. **Guardrail End** - May be painted a warning color and may include a breakaway or redirection design feature not to be confused with an [impact attenuator/crash cushion](#).



40. **Other Traffic Barrier** - Longitudinal barriers other than guardrails, concrete traffic barriers, or cable barriers. They may be composed of material such as wood or rock.

41. **Overhead Sign Support** - Horizontal support for sign(s).



42. **Ditch** - Developed primarily to collect and move water.
43. **Other Post / Pole / Support** - Post, pole, or support excluding traffic sign/signal support, utility pole, and street light support.
44. **Wall** - A primarily vertical structure composed of concrete, metal, timber, stone, which is not part of a building or a fence, but typically is used for retaining earth, abating noise, and separating areas, but not for containment as in a primary function of a fence. Also not included are wing walls which are attached to the ends of bridge abutments or culverts and extend back at an angle from the roadway.
45. **Cable Barrier** - A flexible barrier system which uses more than one cable typically supported by steel posts. These can be used on the roadside or in a [median](#). They are designed to help lesson impact or keep vehicles within the confines of the road.



**Cable Barrier** (Source: MMUCC)

**Note:** A single strand cable system should be marked as "Other."

46. **Bridge Overhead Structure** - Any part of a bridge that is over the reference or subject roadway.



47. **Overhead Line / Cable** - Utility line, cable, etc. suspended either along or over the roadway. Excludes lines or cables to traffic signals. These should be marked

"Traffic Signal Support."

U. **Unknown** - The vehicle struck a **fixed object**; however, the type of object could not be determined.

j. **DISTRACTED / INATTENTIVE CODES**

DISTRACTED / INATTENTIVE CODES			
1. External Distraction	5. Communication Device - Hand-held	9. Eating / Drinking	13. Computer Equipment / Electronic Games / etc.
2. Passengers	6. Communication Device - Hands Free	10. Reading	14. Adjusting Vehicle Controls
3. Stereo / Audio / Video Equipment	7. Communication Device - Texting / E-mailing	11. Tobacco Use	15. Other (Explain)
4. Navigation Device	8. Communication Device - Web Browsing	12. Grooming	

1. **External Distraction** - Something external to the vehicle distracted the driver or pedestrian. Explain in *Section 9 - Narrative / Statements*.
2. **Passengers** - Passenger(s) in the vehicle distracted the driver.
3. **Stereo / Audio / Video Equipment** - The driver or pedestrian was distracted using stereo, audio, and/or video equipment. Includes equipment both originally installed by the vehicle manufacturer and other equipment of this type in the vehicle.
4. **Navigation Device** - The driver or pedestrian was distracted while viewing or operating a navigation device. This includes GPS or other devices being used for navigation.
5. **Communication Device - Hand-held** - The driver or pedestrian was distracted by using or attempting to use a hand-held mobile communication device to include a mobile telephone.
6. **Communication Device - Hands Free** - The driver or pedestrian was distracted by using or attempting to use a mobile hands-free communication device. This includes "On-Star" and other similar services.
7. **Communication Device - Texting / E-mailing** - The driver or pedestrian was distracted by texting / e-mailing / etc. on a mobile communication device to include a mobile telephone.
8. **Communication Device - Web Browsing** - The driver or pedestrian was distracted by web browsing or other application not listed (i.e., games, etc.) on a mobile communication device to include a mobile telephone.
9. **Eating / Drinking** - The driver or pedestrian was distracted by eating or drinking.
10. **Reading** - The driver or pedestrian was distracted by reading a book, newspaper, magazine, etc.
11. **Tobacco Use** - The driver or pedestrian was distracted by the use of tobacco. This includes the use of a cigarette lighter.
12. **Grooming** - The driver or pedestrian was distracted by grooming him or herself.
13. **Computer Equipment / Electronic Games / etc.** - The driver or pedestrian was distracted by using computer equipment / electronic games, etc. This does not include use of a mobile telephone as a computing / gaming device.
14. **Adjusting Vehicle Controls** - The driver was distracted by adjusting vehicle controls. This does not include adjusting radio controls. These should be shown as "Stereo / Audio / Video Equipment."

15. **Other (Explain)** - The driver or pedestrian was distracted by something not listed. Explain in *Section 9 - Narrative and Statements*.

k. **VEHICLE TYPE CODES**

VEHICLE TYPE CODES			
1. Motor Vehicle In Transport	3. Working Motor Vehicle	5. Animal Drawn Vehicle / Animal Ridden For Transport Purposes	
2. Parked Motor Vehicle	4. Pedalcycle	U. Unknown	

1. **Motor Vehicle in Transport** - A motor vehicle being used for moving persons or property from one place to another, and is either in motion, in readiness for motion, or on a roadway, but not parked in a designated area. Includes a motor vehicle moving, stopped, disabled, or abandoned on a roadway other than areas designated for parking. See examples for [Motor Vehicle in Transport](#) in Glossary, page 19.
  2. **Parked Motor Vehicle** - A motor vehicle not in-transport, other than a [working motor vehicle](#), that is not in motion and not located on the roadway. A "parked motor vehicle" should be considered to be in-transport during periods when parking is prohibited in roadway lanes used for travel during some periods and for parking during other periods. (See page 31, [Parked MV](#), for inclusions and exclusions).
  3. **Working Motor Vehicle** - A motor vehicle in the act of performing construction, maintenance, or utility work related to the [trafficway](#). This "work" may be located within open or closed portions of the trafficway and motor vehicles performing these activities can be within or outside of the trafficway boundaries. For instance, a utility truck parked off the trafficway in a field placing a concrete culvert on the trafficway. (See page 32, [Working MV](#), for inclusions and exclusions).
  4. **Pedalcycle** - A non-motorized device operated solely by pedals propelled by human power. (See page 28, [Pedalcycle](#), for inclusions and exclusions).
  5. **Animal Drawn Vehicle / Animal Ridden For Transport Purposes** - A vehicle or conveyance drawn by an animal for transportation purposes or an animal being ridden by a person(s) for transportation purposes.
- U. **Unknown** - The type of vehicle is unknown

l. **OTHER VEHICLE CODES**

OTHER VEHICLE CODES			
1. Riding Mower / Garden Tractor	3. Snowmobile	5. Animal Drawn Vehicle / Animal Ridden For Transportation	6. Low Speed Vehicle
2. Golf Cart	4. Forklift		7. Other (Explain)

1. **Riding Mower / Garden Tractor** - Device originally constructed as a lawn mower or garden tractor.
2. **Golf Cart** - Device originally constructed as an electric or gasoline powered golf cart. This includes any modified or hybrid golf cart converted for transportation use only.
3. **Snowmobile** - A motorized vehicle with runners and a continuous track, used for traveling over snow.
4. **Forklift** - A motorized lifting device with two long rigid steel bars that can be raised and lowered, used especially to move pallets loaded with boxes or other goods.
5. **Animal Drawn Vehicle / Animal Ridden For Transportation** - A vehicle or conveyance drawn by an animal for transportation purposes or an animal being

ridden by a person(s) for transportation purposes.

6. **Low Speed Vehicle (LSV)** - A motor vehicle with four or more wheels whose top speed is greater than 20 miles-per-hour, but not greater than 25 miles-per-hour.

LSVs are required to be equipped with basic items of safety equipment: tail lamps, reflex reflectors, parking brake, windshields constructed with safety glass, rearview mirrors, seat belts, and vehicle identification numbers.

7. **Other (Explain)** - Includes all other vehicles that do not fall into the previous categories (e.g., mini-truck). Explain in *Section 9 - Narrative and Statements*.



(Mini-truck)

IX. SECTION 9 - NARRATIVE / STATEMENTS

9. NARRATIVE / STATEMENTS (If additional room is necessary, use Section 11 - Narrative / Statements Continuation)

- a. The investigating officer uses this section to give an objective view of the crash. The section also includes any required explanations as indicated in other sections of the report.
- b. The investigating officer's statement should be clearly separated from those of others (such as driver and/or witness statements).
- c. Include vehicle owner information in the narrative when the owner is not included on the report but is pertinent to the investigation.
- d. Include towed unit information in the narrative.
- e. Use *Section 11 - Narrative / Statements Continuation* if additional space is needed.
- f. Numbering Roadway Lanes - Engineering standards call for lane numbering on roadways with two or more lanes in the same direction to begin on the inside of the roadway next to the **median** or barrier and progress to the outside lanes (or to the right). This method should be used when referring to lane numbers in the narrative.

Example: Lane one of a roadway with four lanes of travel in the same direction would be the inside lane next to the **median** or barrier and lane four would be the outside lane next to the shoulder (or right side of the roadway). See example below.



X. **SECTION 10 - REPORTING AND REVIEWING OFFICER INFORMATION**

<b>10. REPORTING AND REVIEWING OFFICER INFORMATION</b>			
REPORTING OFFICER NAME	DSN / BADGE NO.	BEAT / ZONE	TROOP / DISTRICT / PRECINCT
REVIEWING OFFICER NAME	DSN / BADGE NO.	REVIEWING OFFICER 2 NAME	DSN / BADGE NO.

- a. **REPORTING OFFICER NAME** - Print the reporting officer's name.
- b. **DSN / BADGE NO.** - The reporting officer's department serial number (DSN) or badge number.
- c. **BEAT / ZONE** - The reporting officer's beat or zone assignment (if applicable).
- d. **TROOP / DISTRICT / PRECINCT** - The reporting officer's troop, district, or precinct assignment (if applicable).
- e. **REVIEWING OFFICER NAME** - Print the reviewing officer's name.
- f. **DSN / BADGE NO.** - The reviewing officer's department serial number (DSN) or badge number.
- g. **REVIEWING OFFICER 2 NAME** - This is an optional field. It may be used to show any additional officer's review of the report. This may include a reviewing reconstructionist or additional supervisor review.
- h. **DSN / BADGE NO.** - The reviewing officer's department serial number (DSN) or badge number.

XI. **SECTION 11 - NARRATIVE / STATEMENTS CONTINUATION**

Page Not Used      REPORT # \_\_\_\_\_      PAGE \_\_\_\_\_ OF \_\_\_\_\_

11. NARRATIVE / STATEMENTS CONTINUATION (If additional room is necessary use Narrative / Statements Continuation / Supplement)

This section is used as a continuation of *Section 9 - Narrative / Statements*.

**PAGE NOT USED** - (Found on back of page containing Sections 8, 9, and 10) Mark if the *Narrative / Statements Continuation* page is not utilized. The page should be counted sequentially as part of the report.

# MISSOURI UNIFORM CRASH REPORT CONTINUATION / SUPPLEMENT

## GENERAL INFORMATION

**Note:** *Section 7 - Drivers, Vehicles, Owners, and Occupants* must be completed for each vehicle involved in the crash. The standard report includes two pages with this section. Additional pages with this section must be added for crashes involving more than two vehicles. Mark "**Page Not Used**" if a page with *Section 7* is not utilized.

MISSOURI UNIFORM CRASH REPORT			<input type="checkbox"/> Continuation	<input type="checkbox"/> Supplement	ORIGINAL REPORT # _____	PAGE _____ OF _____
SUPPLEMENTAL REPORT NO.		SUPPLEMENTAL REPORT DATE		AGENCY NAME AND ORI		
CRASH DATE	TRP / DIST / PCT	COUNTY				
REPORTING OFFICER NAME			DSN / BADGE NO.	SUPPLEMENTAL REVIEWING OFFICER NAME		DSN / BADGE NO.

There are three continuation / supplement forms to the Missouri Uniform Crash Report. These include:

1. Pedestrians / Occupants Continuation / Supplement (SHP-224) - Completed when more than one pedestrian is involved in a crash or more than six occupants (including the driver) from one vehicle are involved in a crash.
2. Narrative / Statements Continuation / Supplement (SHP-220) - Completed when more space is needed to complete *Section 11 - Narrative / Statements Continuation* or when additional narrative information is acquired after the original report has been submitted.
3. Railway Vehicle Continuation / Supplement (SHP-215) - Completed when a [railway vehicle](#) is involved in a motor vehicle crash.

With the exception of the *Railway Vehicle Continuation / Supplement*, forms are completed according to related field instructions in the original report. Instructions for the [Railway Vehicle Continuation / Supplement](#) begin on page 114.

**Continuation** - Use continuations provided by STARS to record additional information when space allowed on the standard report is insufficient. Submit continuations with the original report as one package. It is not necessary to complete header fields on a continuation form; however, the report / case / incident number is required on each page.

**Supplement** - Use supplements provided by STARS to record additional information not included in the original report. All header fields must be completed.

**Note:** STARS only needs supplement reports involving fatalities or those significantly altering the original report; however, agencies may send any supplements to STARS. Reports must be submitted on forms provided by STARS or approved by the Patrol Records Division of the Missouri State Highway Patrol.

### Specific Field Instructions for Continuation / Supplement

Follow the instructions in the front of the manual for fields not listed below.

- I. **CONTINUATION** - Mark if the page is a continuation of, and will be submitted with, the original report.
- II. **SUPPLEMENT** - Mark if the page is a supplement to, and was not submitted with, the original report.
- III. **ORIGINAL REPORT #** - The submitting agency's original report / case / incident number. This must be completed on continuation and supplement forms.



- IV. **PAGE \_\_\_ OF \_\_\_** - The first blank is the page number and second is the total number of pages. Continuations should reflect a continuation of the standard report's page numbers. Supplements should normally begin with "1" and end with the total number of supplemental pages.
- V. **SUPPLEMENT REPORT NO.** - The submitting agency's additional supplement number, if applicable.
- VI. **SUPPLEMENT REPORT DATE** - Enter the date the supplement was completed.
- VII. **AGENCY NAME AND ORI** - Enter agency name and Originating Agency Identifier (ORI) number of the agency completing the supplement. Other information pertinent to the department may be shown here.
- VIII. **CRASH DATE** - Enter the date the crash occurred.
- IX. **TRP / DIST / PCT** - Enter the appropriate number(s) or letter(s) to indicate the troop, district, or precinct in which the crash occurred. Enter "NA" if this field is not applicable.
- X. **COUNTY** - Enter the name of the county in which the crash occurred. Exception: Crashes occurring in the City of St. Louis enter "St. Louis City."
- XI. **REPORTING OFFICER NAME** - Print the reporting officer's name.
- XII. **DSN / BADGE NO.** - The reporting officer's department serial number (DSN) or badge number.
- XIII. **SUPPLEMENTAL REVIEWING OFFICER NAME** - Print the officer's name who reviewed the supplemental report.
- XIV. **DSN / BADGE NO.** - The reviewing officer's department serial number (DSN) or badge number.
- XV. See [Section 5 - Pedestrian](#) of this manual (page 53) for instructions on completing the pedestrian fields of the continuation / supplement forms.
- See [Section 7 - Drivers, Vehicles, Owners, & Occupants](#) of this manual (page 85) for instructions on completing the occupant fields of the continuation / supplement forms.
- See [Section 9 - Narrative / Statements](#) of this manual (page 110) for instructions on completion of this field of the continuation / supplement forms.

# RAILWAY VEHICLE CRASH CONTINUATION / SUPPLEMENT (SHP-215)

**MISSOURI UNIFORM CRASH REPORT**

Continuation  Supplement

ORIGINAL REPORT # \_\_\_\_\_

PAGE \_\_\_\_\_ OF \_\_\_\_\_

SUPPLEMENTAL REPORT NO.		SUPPLEMENTAL REPORT DATE		AGENCY NAME AND ORI																											
CRASH DATE	TRP / DIST / PCT	COUNTY																													
REPORTING OFFICER NAME			DSN / BADGE NO.	SUPPLEMENTAL REVIEWING OFFICER NAME			DSN / BADGE NO.																								
<b>TRAIN INFORMATION</b>																															
VEH. NO.	TRAIN ID NUMBER	LEAD ENGINE NO.	MAKE	MODEL	LOCOMOTIVE ENGINEER CERTIFICATE	<input type="checkbox"/> Yes <input type="checkbox"/> No	EXPIRATION DATE																								
RETRACTABLE FLANGE WHEELED MOTOR VEHICLE <input type="checkbox"/> NA		VEH YEAR	LICENSE - PLATE NO.	STATE	YEAR	VIN	COLOR																								
HEADLIGHT IN USE	HORN IN USE	BELL IN USE	TOTAL NO. OF OCCUPANTS		TRAIN DAMAGE (Mark all damaged areas) <input type="checkbox"/> None / No Damage																										
<input type="checkbox"/> Yes <input type="checkbox"/> No <input type="checkbox"/> Unknown	<input type="checkbox"/> Yes <input type="checkbox"/> No <input type="checkbox"/> Unknown	<input type="checkbox"/> Yes <input type="checkbox"/> No <input type="checkbox"/> Unknown			INITIAL IMPACT NO:																										
NO. OF CARS	SPEED	DISTANCE FROM IMPACT AREA TO FRONT OF LEAD ENGINE		LEAD ENGINE		<table border="1" style="display: inline-table; border-collapse: collapse;"> <tr> <td>2</td><td>3</td><td>4</td><td>5</td><td>6</td><td>7</td> <td>18 - Undercarriage</td> <td>22 - Cargo</td> </tr> <tr> <td>1</td><td>15</td><td>16</td><td>17</td><td>8</td><td></td> <td>19 - Windshield</td> <td>23 - Unknown</td> </tr> <tr> <td>14</td><td>13</td><td>12</td><td>11</td><td>10</td><td>9</td> <td>20 - Burned</td> <td>24 - Other (Explain)</td> </tr> </table>		2	3	4	5	6	7	18 - Undercarriage	22 - Cargo	1	15	16	17	8		19 - Windshield	23 - Unknown	14	13	12	11	10	9	20 - Burned	24 - Other (Explain)
2	3	4	5	6	7	18 - Undercarriage	22 - Cargo																								
1	15	16	17	8		19 - Windshield	23 - Unknown																								
14	13	12	11	10	9	20 - Burned	24 - Other (Explain)																								
RAILROAD CO. - TRACKS		OWNER NAME & ADDRESS (Street, City, State, Zip)																													
RAILROAD CO. - TRAIN		OWNER NAME & ADDRESS (Street, City, State, Zip)																													
<b>TRAFFIC CONTROL DEVICE AT CROSSING</b> <input type="checkbox"/> NA			UPON INVESTIGATING OFFICER'S ARRIVAL AT SCENE:		CROSSING GATES DOWN	LIGHTS FLASHING	BELLS RINGING																								
<input type="checkbox"/> Lights / Gates / Bell Combination <input type="checkbox"/> Lights / Bell Combination <input type="checkbox"/> Passive Warning (Crossbucks Only)			<input type="checkbox"/> Lights / Gates <input type="checkbox"/> Lights Only <input type="checkbox"/> Pavement Markings		<input type="checkbox"/> Yes <input type="checkbox"/> No <input type="checkbox"/> NA	<input type="checkbox"/> Yes <input type="checkbox"/> No <input type="checkbox"/> NA	<input type="checkbox"/> Yes <input type="checkbox"/> No <input type="checkbox"/> NA																								
ADVANCE WARNING SIGNS IN PLACE		DISTANCE FROM SIGN TO NEAREST RAIL	CROSSING SURFACE (Rubber, Asphalt, etc.)		DOT / AAR CROSSING ID. NO.	QUIET ZONE																									
<input type="checkbox"/> Yes <input type="checkbox"/> No <input type="checkbox"/> NA		<input type="checkbox"/> NA <input type="checkbox"/> Miles <input type="checkbox"/> Feet	<input type="checkbox"/> NA		<input type="checkbox"/> NA	<input type="checkbox"/> Yes <input type="checkbox"/> No <input type="checkbox"/> Unknown																									
TRAIN ACTION / SEQUENCE OF EVENTS CODES					DISTRACTED / INATTENTIVE CODE(S)																										
SEQUENCE OF EVENTS CODES FOR TRAIN <input type="checkbox"/> Unknown					(See Codes in Section 8) <input type="checkbox"/> NA																										
PROBABLE CONTRIBUTING CIRCUMSTANCES - TRAIN <input type="checkbox"/> None																															
<input type="checkbox"/> Train Defects (Explain)		<input type="checkbox"/> Drugs		<input type="checkbox"/> Failed To Use Lights		<input type="checkbox"/> Failed To Secure Load / Improper Loading																									
<input type="checkbox"/> Excessive Speed		<input type="checkbox"/> Vision Obstructed		<input type="checkbox"/> Obstruction on Tracks		<input type="checkbox"/> Derailment																									
<input type="checkbox"/> Violation Signal / Sign		<input type="checkbox"/> Operator Fatigue / Asleep		<input type="checkbox"/> Track Defects		<input type="checkbox"/> Distracted / Inattentive (Designate Type Above)																									
<input type="checkbox"/> Alcohol		<input type="checkbox"/> Failed To Sound Horn		<input type="checkbox"/> Improper Riding / Clinging To Train Exterior		<input type="checkbox"/> Unknown (Explain)																									
<b>ENGINEER &amp; CONDUCTOR</b>																															
NAME (Last, First, MI)				DATE OF BIRTH	SEX	SEAT LOC	INJ																								
ADDRESS (Street, City, State, Zip)				MM-DD-YYYY																											
ENGINEER:																															
CONDUCTOR:																															
<b>TRAIN CREW MEMBERS &amp; PASSENGERS</b> - List additional passengers on Pedestrian / Occupant Continuation																															

Complete and submit the *Railway Vehicle Crash Continuation / Supplement* any time a **railway vehicle** is involved in a reportable motor vehicle crash.

**Important:** To be considered a reportable motor vehicle crash involving a **railway vehicle**, the **first harmful event** must be between the railway vehicle and a **motor vehicle in transport**.

Example: An incident where a train derails and then strikes a motor vehicle in transport is not a reportable motor vehicle crash because the first harmful event is the derailment. However, an incident where a train strikes a motor vehicle and then derails would be a reportable motor vehicle crash because the first harmful event is the collision of the train with a motor vehicle in transport.

**Note:** Throughout these instructions the terms "Train" and "**Railway Vehicle**" are used interchangeably.

I. **GENERAL CRASH INFORMATION**

- a. **CONTINUATION** - Mark if the page is a continuation of, and will be submitted with, the original report.
- b. **SUPPLEMENT** - Mark if the page is a supplement to, and was not submitted with, the original report.
- c. **ORIGINAL REPORT #** - The submitting agency's original report / case / incident number. This must be completed on continuation and supplement forms.
- d. **PAGE \_\_\_ OF \_\_\_** - The first blank is the page number and second is the total number of pages. Continuations should reflect a continuation of the standard report's page numbers. Supplements should normally begin with "1" and end with the total number of supplemental pages.
- e. **SUPPLEMENT REPORT NO.** - The submitting agency's additional supplement number, if applicable.
- f. **SUPPLEMENT REPORT DATE** - Enter the date the supplement was completed.
- g. **AGENCY NAME AND ORI** - Enter agency name and Originating Agency Identifier (ORI) number of the agency completing the supplement. Other information pertinent to the department may be shown here.
- h. **CRASH DATE** - Enter the date the crash occurred.
- i. **TRP / DIST / PCT** - Enter the appropriate number(s) or letter(s) to indicate the troop, district, or precinct in which the crash occurred. Enter "NA" if this field is not applicable.
- j. **COUNTY** - Enter the name of the county in which the crash occurred. Exception: Crashes occurring in the City of St. Louis enter "St. Louis City."
- k. **REPORTING OFFICER NAME** - Print the reporting officer's name.
- l. **DSN / BADGE NO.** - The reporting officer's department serial number (DSN) or badge number.
- m. **SUPPLEMENTAL REVIEWING OFFICER NAME** - Print the officer's name who reviewed the supplemental report.
- n. **DSN / BADGE NO.** - The reviewing officer's department serial number (DSN) or badge number.

II. **TRAIN INFORMATION**

- a. **VEH NO.** - The vehicle number assigned by the investigator.
- b. **TRAIN ID NUMBER** - Enter the identification number on a train. This is normally available from the conductor. Enter "NA" if this is a retractable flange wheeled vehicle.
- c. **LEAD ENGINE NO.** - The lead engine number. This is often stenciled in large numbers on the side of the lead engine. It is not the same as the Train ID Number. Enter "NA" if this is a retractable flange wheeled vehicle.
- d. **MAKE** - The lead engine or retractable flange wheeled motor vehicle manufacturer. If not available or unknown, enter "Unknown."

- e. **MODEL** - The lead engine or retractable flange wheeled motor vehicle model name or number. If not available or unknown, enter "Unknown."

f. **LOCOMOTIVE ENGINEER CERTIFICATE**

- i. **Yes** - Mark if the engineer is able to produce his/her locomotive engineer certificate.
- ii. **No** - Mark if the engineer is unable to produce or does not have a locomotive engineer certificate. Mark if the operator is not required to have a certificate. (Note: Only locomotive engineers are required to have an Engineer's Certificate).
- iii. **Expiration Date** - Enter the expiration date of the engineer's locomotive engineer certificate (if available). Enter "NA" if unknown, not available, or a certificate is not required.

g. **RETRACTABLE FLANGE WHEELED MOTOR VEHICLE**

Completed when a rail maintenance vehicle (pickups, heavy duty trucks, etc.) with retractable flange wheels, which can be operated either on rails or a roadway, is involved in the crash.

- i. **NA** - Mark if a retractable flange wheeled motor vehicle is not involved. If marked, all other fields of this sub-section must be blank.
- ii. **VEH. YEAR** - Enter four-digit vehicle model year. If in doubt, use year indicated on title or as obtained from the Department of Revenue.
- iii. **LICENSE-PLATE NO.** - Enter the state license plate number, if licensed. Enter "NOTREQ" if no license plate is displayed.
- iv. **STATE** - Enter state / province issuing the vehicle license using the standard NCIC two letter abbreviation as shown in [Appendix C - United States, Canada, and Mexico Abbreviations](#), page 133. Enter "XX" for licenses issued by entities not listed in the appendix. Enter "NA" if no license plate is displayed.
- v. **YEAR** - Enter four-digit year designation of plate. Enter the current year for license plates not displaying a year. Enter "NA" if no license plate is displayed.
- vi. **VIN** - Enter the vehicle identification number (VIN) as shown on the vehicle.
- vii. **COLOR** - Enter the vehicle color(s) starting at the top. Use [NCIC codes](#) on page 67. Example: "BLK" | "RED" indicates the vehicle is predominately black on top and red on the bottom.

h. **HEADLIGHT IN USE**

- i. **Yes** - Mark if the railway vehicle's headlight was illuminated at the time of the crash.
- ii. **No** - Mark if the railway vehicle's headlight was not illuminated at the time of the crash.
- iii. **Unknown** - Mark if the investigator could not determine if the railway vehicle's headlight was illuminated at the time of the crash.

i. **HORN IN USE**

- i. **Yes** - Mark if the railway vehicle's horn was sounding just prior to or during the crash.
- ii. **No** - Mark if the railway vehicle's horn was not sounding just prior to or during the crash.
- iii. **Unknown** - Mark if the investigator could not determine if the horn was sounding just prior to or during the crash.

j. **BELL IN USE**

- i. **Yes** - Mark if the railway vehicle's bell was sounding just prior to or during the crash.
- ii. **No** - Mark if the railway vehicle's bell was not sounding just prior to or during the crash or if the vehicle is not equipped with a bell.
- iii. **Unknown** - Mark if the investigator could not determine if the bell was sounding just prior to or during the crash.

k. **TOTAL NO. OF OCCUPANTS** - The total number of occupants of the **railway vehicle**. Occupants include engineer, conductor, train crew members, and passengers.

l. **TRAIN DAMAGE** - Indicate **damage** sustained by the **railway vehicle**, if any, during the crash.

- i. **None / no damage** - Mark if the railway vehicle (including any engine or cars and / or cargo) was not damaged.
- ii. **Initial impact no.** - Enter the number corresponding to the initial impact point on the lead engine. If the initial impact point was on another engine or cars, enter #21. If initial impact was to the cargo, enter #22. "NA" cannot be entered in this field.
- iii. **Vehicle damage** - Circle number(s) corresponding to the damaged areas of the lead engine. If there was damage to other engines or cars, circle #21.

m. **NO. OF CARS** - The total number of engines and cars in the train. This is available from the conductor. This cannot be "0".

n. **SPEED** - The estimated speed of the train at the time of collision. This is available from the engineer.

o. **DISTANCE FROM IMPACT AREA TO FRONT OF LEAD ENGINE** - The distance from the area of impact to the front of the lead engine at its final resting position.

p. **RAILROAD CO. - TRACKS**

**OWNER NAME AND ADDRESS** - The railroad tracks owner's name and address. This is available from the conductor.

q. **RAILROAD CO. - TRAIN**

**OWNER NAME AND ADDRESS** - The train owner's name and address. This is available from the conductor.

III. **TRAFFIC CONTROL DEVICE AT CROSSING INFORMATION**

- a. **NA** - Mark if the crash did not occur at a railroad crossing.
- b. **TRAFFIC CONTROL DEVICE AT CROSSING** - Mark up to three types of crossing signals present at the scene. This indicates only the presence of the signals, not whether they were operating at the time of the crash.
  - i. **LIGHTS / GATES / BELL COMBINATION** - Mark if there is a combination of warning lights, crossing gates and bells at the crossing.

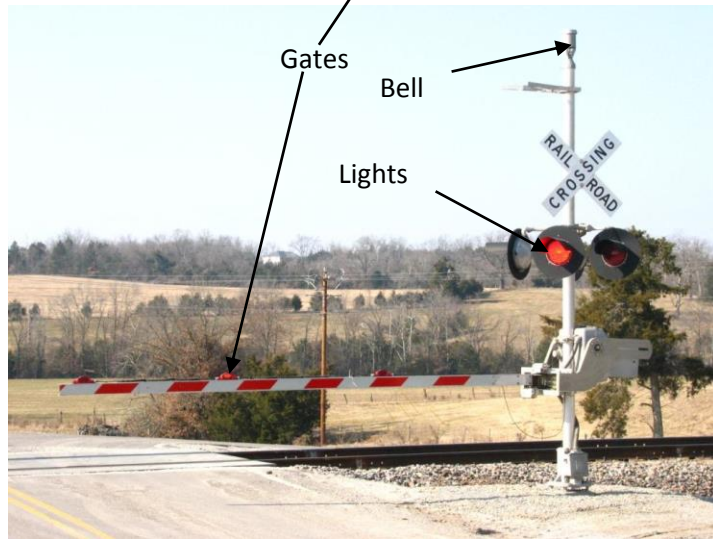
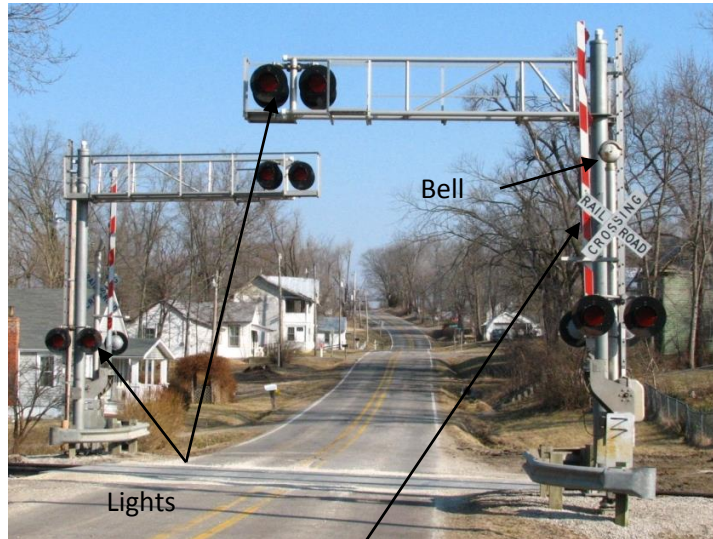

- ii. **LIGHTS / BELL COMBINATION** - Mark if there is a combination of warning lights and bells at the crossing.
- iii. **PASSIVE WARNING (CROSSBUCKS ONLY)** - Mark if there are only passive warnings at the crossing. This normally consists of cross bucks.



- iv. **LIGHTS / GATES** - Mark if there is a combination of warning lights and crossing gates at the crossing.
- v. **LIGHTS ONLY** - Mark if there are warning lights at the crossing, but no bells or gates.
- vi. **PAVEMENT MARKINGS** - Mark if there are pavement markings warning of the approaching crossing.



- vii. **FLAGMAN** - Movement of traffic at the railroad crossing is directed by a flagman.
- viii. **NONE** - Mark if the crash occurred at a railroad crossing; however, there were no crossing signals of any type.

c. **UPON INVESTIGATING OFFICER'S ARRIVAL AT SCENE**

i. **Crossing gates down**

- 1. **Yes** - Mark to indicate crossing gates were installed and down across the roadway.
- 2. **No** - Mark to indicate crossing gates were installed and up.
- 3. **NA** - Mark if there were no crossing gates installed at the crossing or the crash did not occur at a crossing.

ii. **Lights flashing**

- 1. **Yes** - Mark to indicate crossing lights were installed and flashing.
- 2. **No** - Mark to indicate crossing lights were installed and not flashing.
- 3. **NA** - Mark if there were no flashing lights installed at the crossing or the crash did not occur at a crossing.

iii. **Bells ringing**

- 1. **Yes** - Mark to indicate crossing bells were installed and ringing.

2. **No** - Mark to indicate crossing bells were installed and not ringing.
3. **NA** - Mark if there were no crossing bells installed at the crossing or the crash did not occur at a crossing.

d. **ADVANCE WARNING SIGNS IN PLACE**

- i. **Yes** - Mark if there were signs warning the driver of the involved motor vehicle that a railroad crossing was ahead.

Includes (but is not limited to):



- ii. **No** - Mark if there were no advance warning signs in place.
  - iii. **NA** - Mark if this field is not applicable to the crash, i.e., private road, crash not at a crossing, etc.
- e. **DISTANCE FROM SIGN TO NEAREST RAIL** - If advance warning signs were present, measure and enter the distance from the nearest rail to the farthest warning sign based on the involved motor vehicle's direction of travel.
- i. **NA** - Mark if there were no advance warning signs in place.
  - ii. **Miles** - Mark if the distance recorded was in miles.
  - iii. **Feet** - Mark if the distance recorded was in feet.
- f. **CROSSING SURFACE** - Identify the surface type within the crossing, i.e., rubber, wood, asphalt, concrete, etc.
- NA** - Mark if the crash did not occur at a crossing.
- g. **DOT / AAR CROSSING ID. NO.** - Enter the DOT / AAR Crossing Identification Number located on the crossing control box and/or cross bucks.



**NA** - Mark if the crash did not occur at a crossing or there was no control box and/or cross bucks present at the crossing.



h. **QUIET ZONE**

- i. **Yes** - Mark if the crash occurred in a quiet zone established by local ordinance.
- ii. **No** - Mark if the crash did not occur in a quiet zone.
- iii. **Unknown** - Mark if the investigator is unable to determine if the crash occurred in a quiet zone.

IV. **TRAIN ACTION / SEQUENCE OF EVENTS CODES** - This sub-section describes the railway vehicle action(s) from just prior to the first **unstabilized event** to final rest. All sequence of events, animal codes, and fixed object codes must be explained in *Section 9 - Narrative / Statements*. All codes are listed in *Section 8 - Codes*, page 92.

- a. **Additional Codes Listed In Narrative** - Mark if there are more than ten sequence of events codes. Codes in excess of ten should be listed in *Section 9 - Narrative / Statements*.
- b. **Unknown** - Mark if the railway vehicle's sequence of events cannot be determined.
- c. **Sequence of Events Codes** - Starting with the railway vehicle's actions just prior to the first **unstabilized event**, identify chronological events associated with the railway vehicle. Write the code for the first event in the first block, second in the second block, etc. Use the codes listed in *Section 8 - Codes*. For a description of the codes, refer to *Section 8 - Codes* in this manual (page 98).

**Note:** Vehicle action code number "34" (Collision Involving a **Motor Vehicle in Transport**) must be shown in the sequence of events in order for it to be considered a motor vehicle crash. The **first harmful event** in the sequence must be between the railway vehicle and a motor vehicle in transport.

**Note:** Animal and fixed object codes are not applicable and documentation of the codes is not required; however, this information must be documented in *Section 9 - Narrative / Statements*.

- d. **DISTRACTED / INATTENTIVE CODE(S)** - This identifies the type of distraction(s) involved when "Distracted / Inattentive" is selected as a probable contributing circumstance. Up to four can be entered. Use the codes listed in *Section 8 - Codes*. For a description of the codes, refer to *Section 8 - Codes* in this manual (page 107). Explain cause of the distraction in *Section 9 - Narrative / Statements*.

**Not Applicable** - Mark if "Distracted / Inattentive" was not marked as a probable contributing circumstance.

V. **PROBABLE CONTRIBUTING CIRCUMSTANCES**

This sub-section is used to record contributing engineer / operator errors, **railway vehicle** defects, and miscellaneous circumstances. Criterion here should be based on whether the circumstances existed in the investigator's judgment and it contributed to the crash. Mark all that apply. If "None," or "Unknown" are marked, then no other circumstances may be marked.

- a. **NONE** - Mark only if, in the investigating officer's opinion, there were no probable contributing circumstances associated with the railway vehicle. When marked, no other circumstances may be marked.
- b. **TRAIN DEFECTS (EXPLAIN)** - Includes railway vehicle defects that may have contributed to the crash. When marked, include an explanation in *Section 9 - Narrative / Statements*.

- c. **EXCESSIVE SPEED** - The railway vehicle exceeded the recommended speed limit for the section of track where the crash occurred.  
  
**Note:** The recommended speed limit is set by various regulatory authorities.
- d. **VIOLATION SIGNAL / SIGN** - Failing to comply with railway signals / signs directing movement of the railway vehicle.
- e. **ALCOHOL** - Includes instances when, in the investigating officer's judgment, use of alcohol by the engineer / operator contributed to the crash. This does not indicate intoxication, only that alcohol consumption contributed to the crash.
- f. **DRUGS** - Includes instances when, in the investigating officer's judgment, use of drugs (legal or illegal) by the engineer / operator contributed to the crash. This does not indicate intoxication, only that drug use contributed to the crash.
- g. **VISION OBSTRUCTED** - Mark if the engineer's / operator's vision was obstructed and this contributed to the crash. Explain in *Section 9: Narrative / Statements*.
- h. **OPERATOR FATIGUE / ASLEEP** - Mark if engineer / operator fatigue or falling asleep contributed to the crash.
- i. **FAILED TO SOUND HORN** - Mark if the engineer / operator failed to sound the railway vehicle's horn when required and this contributed to the crash.
- j. **FAILED TO USE LIGHTS** - Mark if light(s) on the railway vehicle were not illuminated at the time of the crash and this contributed to the crash.
- k. **OBSTRUCTION ON TRACKS** - Mark if an obstruction on or near the tracks contributed to the crash.
- l. **TRACK DEFECTS (Explain)** - Mark if track defect(s) contributed to the crash. Explain in *Section 9 - Narrative / Statements*.
- m. **IMPROPER RIDING / CLINGING TO TRAIN EXTERIOR** - Mark if an engineer / operator or occupant of the railway vehicle was riding or clinging to the vehicle exterior and this contributed to the crash.
- n. **FAILED TO SECURE LOAD / IMPROPER LOADING** - Mark if failure to secure a load on / in the railway vehicle or improper loading of cargo on / in the railway vehicle contributed to the crash.
- o. **DERAILMENT** - Mark if derailment of a railway vehicle contributed to the crash.
- p. **DISTRACTED / INATTENTIVE** - Mark if the engineer / operator was distracted or inattentive and it contributed to the crash. "**Distracted / Inattentive Code(s)**" must be entered when this is marked.
- q. **UNKNOWN (EXPLAIN)** - Mark if it is unknown whether actions on the part of the engineer / operator contributed to the crash or if there was not enough evidence at the scene to ascertain who or what contributed. If marked, no other selections can be made. Explain in *Section 9: Narrative / Statements*.
- r. **OTHER (EXPLAIN)** - Mark if another unlisted factor on the part of the railway vehicle contributed to the crash. Explain in *Section 9: Narrative / Statements*.

VI. **ENGINEER** - The operator of the [railway vehicle](#).

- a. **ENGINEER'S - NAME (LAST, FIRST, MI)** - Enter current legal name using last name, first name, and middle initial format. (**Note:** Do not enter a period after the middle initial).
- b. **ADDRESS (STREET, CITY, STATE, ZIP)** - Enter current address on the line below the name.
- c. **DATE OF BIRTH (MM-DD-YYYY)** - Enter the engineer's birth date in month, day, and year (mm-dd-yyyy) format.
- d. **SEX** - Enter "M" for male, "F" for female, or "U" if the information is unknown.
- e. **SEAT LOC.** - (Seat Location) Enter the code "RC" (Rail Crew) for the engineer's seat location.

**Note:** Use actual seat locations (FL, FR, FC, etc.) for rail maintenance vehicles (pickups, heavy duty trucks, etc.) with retractable flange wheels, which can be operated either on rails or a roadway. Use the codes listed in *Section 8 - Codes*. For a description of the codes, refer to [Section 8 - Codes](#) in this manual (page 92).

- f. **INJ - (Injury)** Enter one code to indicate the injury severity. Use the codes listed in *Section 8 - Codes*. For a description of the codes, refer to [Section 8 - Codes](#) in this manual (page 93).

**Note:** Injuries should be classified on the basis of conditions at the scene of the crash. The exception to this rule applies to fatal injuries ([late death](#)). Injuries that do not meet these criteria may be documented in *Section 9 - Narrative / Statements*.

Enter "5" (None Apparent) for engineers who are not injured, but transported from the scene to a medical facility for precautionary measures. Explain in *Section 9 - Narrative / Statements*.

- g. **TRANSPORT** - Enter one code to indicate whether and how the engineer was transported from the scene to a medical facility for treatment of crash-related injuries. Use the codes listed in *Section 8 - Codes*. For a description of the codes, refer to [Section 8 - Codes](#) in this manual (page 94).

List the name of the transporting agency or person, and medical facility they were transported to in *Section 9 - Narrative / Statements* if applicable.

**Note:** Enter "1" (No) for an engineer who is not injured, but transported from the scene to a medical facility for precautionary measures. In addition, mark "No" if an engineer deceased at the scene is transported. In either case, explain in *Section 9 - Narrative / Statements*.

- h. **EJECTION** - Enter one code to indicate whether the engineer was ejected from the railway vehicle or if the section is not applicable. Use the codes listed in *Section 8 - Codes*. For a description of the codes, refer to [Section 8 - Codes](#) in this manual (page 95).
- i. **AIR BAG** - Enter one code to indicate if air bags were present for the engineer and whether any airbags were deployed. Use the codes listed in *Section 8 - Codes*. For a description of the codes, refer to [Section 8 - Codes](#) in this manual (page 95).
- j. **SAFETY DEVICES** - Enter one or two codes to indicate the type of [safety device](#) used, if any, by the engineer. Use the codes listed in *Section 8 - Codes*. For a description of the codes, refer to [Section 8 - Codes](#) in this manual (page 97).

- k. **PHONE NUMBER** - Enter the engineer's telephone number, including the area code.

## VII. CONDUCTOR

- a. **CONDUCTOR'S - NAME (LAST, FIRST, MI)** - Enter current legal name using last name, first name, and middle initial format. (**Note:** Do not enter a period after the middle initial).
- b. **ADDRESS (STREET, CITY, STATE, ZIP)** - Enter current address on the line below the name.
- c. **DATE OF BIRTH (MM-DD-YYYY)** - Enter the conductor's birth date in month, day, and year (mm-dd-yyyy) format.
- d. **SEX** - Enter "M" for male, "F" for female, or "U" if the information is unknown.
- e. **SEAT LOC.** - (Seat Location) Enter the code "RC" (Rail Crew) for the conductor's seat location.

**Note:** Use actual seat locations (FL, FR, FC, etc.) for rail maintenance vehicles (pickups, heavy duty trucks, etc.) with retractable flange wheels, which can be operated either on rails or a roadway. Use the codes listed in *Section 8 - Codes*. For a description of the codes, refer to *Section 8 - Codes* in this manual (page 92).

- f. **INJ - (Injury)** Enter one code to indicate the injury severity. Use the codes listed in *Section 8 - Codes*. For a description of the codes, refer to *Section 8 - Codes* in this manual (page 93).

**Note:** Injuries should be classified on the basis of conditions at the scene of the crash. The exception to this rule applies to fatal injuries (*late death*). Injuries that do not meet these criteria may be documented in *Section 9 - Narrative / Statements*.

Enter "5" (None Apparent) for conductors who are not injured, but transported from the scene to a medical facility for precautionary measures. Explain in *Section 9 - Narrative / Statements*.

- g. **TRANSPORT** - Enter one code to indicate whether and how the conductor was transported from the scene to a medical facility for treatment of crash-related injuries. Use the codes listed in *Section 8 - Codes*. For a description of the codes, refer to *Section 8 - Codes* in this manual (page 94).

List the name of the transporting agency or person, and medical facility they were transported to in *Section 9 - Narrative / Statements* if applicable.

**Note:** Enter "1" (No) for a conductor who is not injured, but transported from the scene to a medical facility for precautionary measures. In addition, mark "No" if a conductor deceased at the scene is transported. In either case, explain in *Section 9 - Narrative / Statements*.

- h. **EJECTION** - Enter one code to indicate whether the conductor was ejected from the railway vehicle or if the section is not applicable. Use the codes listed in *Section 8 - Codes*. For a description of the codes, refer to *Section 8 - Codes* in this manual (page 95).
- i. **AIR BAG** - Enter one code to indicate if air bags were present for the conductor and whether any airbags were deployed. Use the codes listed in *Section 8 - Codes*. For a description of the codes, refer to *Section 8 - Codes* in this manual (page 95).
- j. **SAFETY DEVICES** - Enter one or two codes to indicate the type of *safety device* used, if any, by the conductor. Use the codes listed in *Section 8 - Codes*. For a description of

the codes, refer to [Section 8 - Codes](#) in this manual (page 97).

- k. **PHONE NUMBER** - Enter the conductor's telephone number, including the area code.

## VIII. TRAIN CREW MEMBERS & PASSENGERS

- a. **TRAIN CREW MEMBER'S OR PASSENGER'S - NAME (LAST, FIRST, MI)** - Enter current legal name using last name, first name, and middle initial format. (**Note:** Do not enter a period after the middle initial).
- b. **ADDRESS (STREET, CITY, STATE, ZIP)** - Enter current address on the line below the name.
- c. **DATE OF BIRTH (MM-DD-YYYY)** - Enter the individual's birth date in month, day, and year (mm-dd-yyyy) format.
- d. **SEX** - Enter "M" for male, "F" for female, or "U" if the information is unknown.
- e. **SEAT LOC.** - (Seat Location) Enter the code "RC" (Rail Crew) or "CP" (Commercial Passenger) for seat locations.

**Note:** Use actual seat locations (FL, FR, FC, etc.) for rail maintenance vehicles (pickups, heavy duty trucks, etc.) with retractable flange wheels, which can be operated either on rails or a roadway. Use the codes listed in [Section 8 - Codes](#). For a description of the codes, refer to [Section 8 - Codes](#) in this manual (page 92).

- f. **INJ - (Injury)** Enter one code to indicate the injury severity. Use the codes listed in [Section 8 - Codes](#). For a description of the codes, refer to [Section 8 - Codes](#) in this manual (page 93).

**Note:** Injuries should be classified on the basis of conditions at the scene of the crash. The exception to this rule applies to fatal injuries ([late death](#)). Injuries that do not meet these criteria may be documented in [Section 9 - Narrative / Statements](#).

Enter "5" (None Apparent) for those who are not injured, but transported from the scene to a medical facility for precautionary measures. Explain in [Section 9 - Narrative / Statements](#).

- g. **TRANSPORT** - Enter one code to indicate whether and how this individual was transported from the scene to a medical facility for treatment of crash-related injuries. Use the codes listed in [Section 8 - Codes](#). For a description of the codes, refer to [Section 8 - Codes](#) in this manual (page 94).

List the name of the transporting agency or person, and medical facility they were transported to in [Section 9 - Narrative / Statements](#) if applicable.

**Note:** Enter "1" (No) for those who are not injured, but transported from the scene to a medical facility for precautionary measures. In addition, mark "No" if a person deceased at the scene is transported. In either case, explain in [Section 9 - Narrative / Statements](#).

- h. **EJECTION** - Enter one code to indicate whether the person was ejected from the railway vehicle. Use the codes listed in [Section 8 - Codes](#). For a description of the codes, refer to [Section 8 - Codes](#) in this manual (page 95).
- i. **AIR BAG** - Enter one code to indicate if air bags were present for the individual and whether any airbags were deployed. Use the codes listed in [Section 8 - Codes](#). For a description of the codes, refer to [Section 8 - Codes](#) in this manual (page 95).
- j. **SAFETY DEVICES** - Enter one or two codes to indicate the type of [safety device](#) used, if any, by the individual. Use the codes listed in [Section 8 - Codes](#). For a description of the

codes, refer to [Section 8 - Codes](#) in this manual (page 97).

- k. **PHONE NUMBER** - Enter the individual's telephone number, including the area code.

# APPENDIX A

## Short Form Information

**SHORT FORM REQUIRED FIELDS** - Following is a list of required short form fields. These fields have captions or borders shaded gray.

### Section 1

Agency Name and ORI  
Property Damage Only  
Report / Case / Incident Number  
No. of Veh. Inv.  
Crash Date  
Crash Time  
Notified Date  
Time Notified  
Invest. Date  
Time Arrived  
Investigated at Scene  
Crash Type  
Commercial Motor Vehicle Involvement

#### Criteria

### Section 2

County  
Municipality  
Beat / Zone  
Trp / Dist / Pct  
GPS Coordinates  
On  
Rdwy. Dir.  
Distance From  
Location  
Intersecting  
Speed Limit ("On" Roadway)  
Road Maintained By  
Speed Limit ("Intersecting" Roadway)  
Int. Dir.  
GEO - CODE  
Road Condition  
Light Condition

### Section 3

Damage to Property Other Than Vehicles

### Section 6

Collision Diagram  
Compass Direction Before Crash Event(s)

### Section 7

No.  
Driver - Name & Address  
Driver - Date of Birth  
Driver - Air Bag  
Driver - Safety Devices  
Proof of Insurance  
Insurance Company  
Driver/Vehicle Insured  
Vehicle Owner's Name & Address  
License Plate No.  
License State  
VIN  
Towed from Scene?  
Towed Due to Disabling Damage?  
Vehicle Damage  
Initial Impact  
Towed by  
Vehicle Body Types  
Contributing Traffic Conditions  
Sequence of Events  
Animal Codes (If applicable)  
Fixed Object Codes (If applicable)  
Probable Contributing Circumstances  
Distraction / Inattention Codes (If applicable)  
Work Zone  
Traffic Control  
Control Malfunctioning/Inoperative/Missing

### Section 9

Narrative / Statements











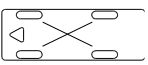
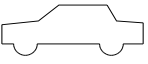

### Section 10

Reporting Officer Name  
DSN / Badge No.  
Beat / Zone  
Troop / District / Precinct  
Reviewing Officer Name  
DSN / Badge No.













## APPENDIX B Diagramming Methods

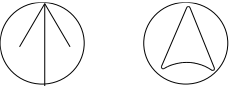
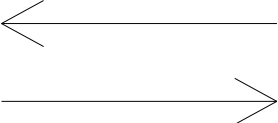







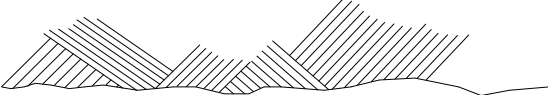
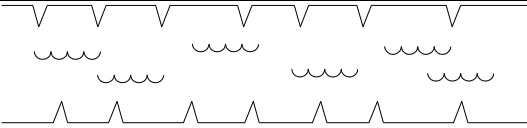

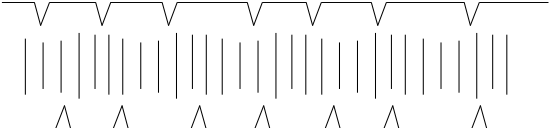
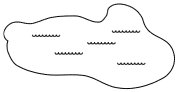
A departmental decision will be made as to type of diagramming method used. An agency may use the Institute of Transportation Engineers (ITE) symbols, template drawings, or drawings produced using computer software. The following is a list of legends and examples of diagramming procedures.

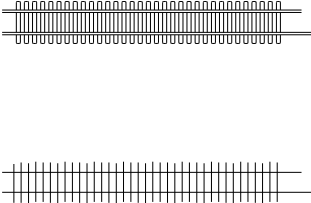
### Template Legend











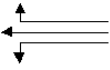

	Passenger Vehicle or Van at Final Rest
	Passenger Vehicle or Van in Motion
	Passenger Vehicle Overturned on Top
	Passenger Vehicle Overturned on Side
	Pickup Truck
	Straight Truck or Dump Truck
	Passenger Bus or Recreational Vehicle
	Cabover Truck Tractor
	Truck Tractor & Trailer Combination with Conventional Tractor Unit
	Box Trailer, House Trailer, or Camper Trailer
	Boat Trailer
	Tanker Trailer
	Locomotive Train Engine
	Farm Tractor

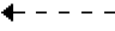



	Motorcycle
	Motorcycle on Side
	Bicycle
	Tricycle
	Body
	Direction Arrow
	Direction of Grade Arrow
	Utility Pole
	Fence
	Guardrail
	Wall Abutment or Concrete Barrier
	Highway Sign
	Electric Signal
	Embankment
	Rock Cut or Bluff Face
	Water Filled Ditch or Canal

	Ditch, Dry or Muddy
	Pond
	Tree
	Bush or Shrub
	Railway Tracks
	Pavement Edge or Curb Line
	Broken Pavement Edge, Gravel or Dirt Road Edge
	Center Line
	Center Line with No Passing Zone
	Shoulder Line
	Skid Mark
	Impact

## ITE Symbol Legend

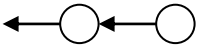
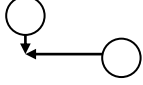
<u>Unit Symbol</u>		<u>Movement Description</u>	
	Vehicle		Moving
	Parked Vehicle		Backing
	Animal		Moving (Not Involved)
	Bicycle		Out of Control
	Fixed Object		Overtake
	Other Object		
	Pedestrian		Indicate Point of Initial Contact
	Train		

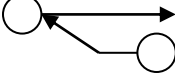
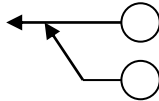
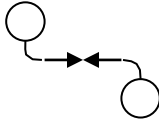
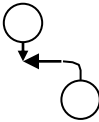
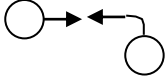
Reflects Initial Impact	Type of Collision	Direction
	Rear End	Same
	Right Angle	Angle
	Head On	Opposite
	Sideswipe	Meeting
	Sideswipe	Passing
	Both Left Turn	Opposite
	Left Turn	Opposite
	Left Turn	Angle Left

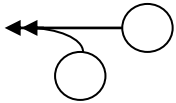
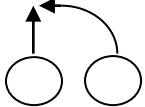
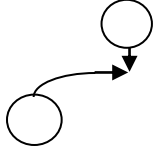
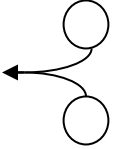
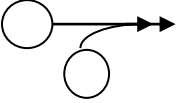
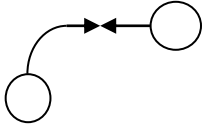
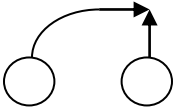
	<p><b>Left Turn</b></p>	<p><b>Angle Right</b></p>
	<p><b>Left Turn</b></p>	<p><b>Same</b></p>
	<p><b>Right Turn</b></p>	<p><b>Opposite</b></p>
	<p><b>Left Turn / Right Turn</b></p>	<p><b>Opposite</b></p>
	<p><b>Right Turn</b></p>	<p><b>Angle Left</b></p>
	<p><b>Right Turn</b></p>	<p><b>Angle Right</b></p>
	<p><b>Right Turn</b></p>	<p><b>Same</b></p>

# APPENDIX C

## United States, Canada, & Mexico Abbreviations

Enter "XX" for foreign countries not listed below.

UNITED STATES			
Alabama	AL		
Alaska	AK		
Arizona	AZ		
Arkansas	AR		
California	CA		
Colorado	CO		
Connecticut	CT		
Delaware	DE		
District of Columbia	DC		
Florida	FL		
Georgia	GA		
Hawaii	HI		
Idaho	ID		
Illinois	IL		
Indiana	IN		
Iowa	IA		
Kansas	KS		
Kentucky	KY		
Louisiana	LA		
Maine	ME		
Maryland	MD		
Massachusetts	MA		
Michigan	MI		
Minnesota	MN		
Mississippi	MS		
Missouri	MO		
Montana	MT		
Nebraska	NB		
Nevada	NV		
New Hampshire	NH		
New Jersey	NJ		
New Mexico	NM		
New York	NY		
North Carolina	NC		
North Dakota	ND		
Ohio	OH		
Oklahoma	OK		
Oregon	OR		
Pennsylvania	PA		
Rhode Island	RI		
South Carolina	SC		
South Dakota	SD		
Tennessee	TN		
Texas	TX		
Utah	UT		
Vermont	VT		
Virginia	VA		
Washington	WA		
West Virginia	WV		
Wisconsin	WI		
Wyoming	WY		
		<b>CANADA</b>	
		Alberta	AB
		British Columbia	BC
		Manitoba	MB
		New Brunswick	NK
		Newfoundland (includes Labrador)	NF
		Northwest Territories	NT
		Nova Scotia	NS
		Ontario	ON
		Nunavut	NU
		Prince Edward Island	PE
		Quebec	PQ
		Saskatchewan	SN
		Yukon (Territory)	YT
		<b>MEXICO</b>	
		Aguascalientes	AG
		Baja California (Northern Section)	BA
		Baja California Sur (Southern Section)	BJ
		Campeche	CE
		Chiapas	CI
		Chihuahua	CH
		Coahuila	CU
		Colima	CL
		Distrito Federal (Mexico, D. F.)	DF
		Durango	DO
		Guanajuato	GU
		Guerrero	GR
		Hidalgo	HL
		Jalisco	JL
		Mexico, D.F. (Distrito Federal)	DF
		Mexico (State)	MX
		Michoacan	MC
		Morelos	MR
		Nayarit	NR
		Nuevo Leon	NL
		Oaxaca	OA
		Puebla	PB
		Queretaro	QU
		Quintana Roo	QR
		San Luis Potosi	SL
		Sinaloa	SI
		Sonora	SO
		Tabasco	TB
		Tamaulipas	TA
		Tlaxcala	TL
		Veracruz	VC
		Yucatan	YU
		Zacatecas	ZA

# APPENDIX D

## How to Find the Responsible Carrier and Correct U.S. DOT Number

**SIDE OF THE VEHICLE**  
In most cases, this is good for name and number. Look for a number preceded by the letters: USDOT.



➔



**DON'T STOP**  
...keep on looking...  
The information on the side of the truck may not be the U.S. DOT number, name, or address of the responsible motor carrier.

➔

**DRIVER INTERVIEW**

1. Is the vehicle leased or rented?
2. Who is the motor carrier responsible for this load?
3. Who is directing and controlling the movement of this vehicle?
4. Where is the motor carrier's principal place of business?



---

**LEASE AGREEMENT**  
identifies the name of the lessee and their U.S. DOT number.



➔

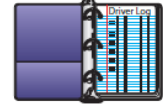

**DRIVER'S LOG**  
contains the name of the motor carrier and the city and State for the carrier's principal place of business.

➔

**SHIPPING PAPERS**  
provide the name of the motor carrier responsible for the load, but not the carrier's U.S. DOT number.



**NOTE: VEHICLE REGISTRATION**  
Generally good for identifying owner or registrant. CAREFUL: This may not be the responsible carrier!

**FMCSA WEB SITE:** <http://safer.fmcsa.dot.gov/CompanySnapshot.aspx> is an excellent source for verifying a motor carrier's U.S. DOT number, legal name, "doing business as" name, physical address, and phone number.

Revised 06/05

**Federal Motor Carrier Safety Administration**



**U.S. Department of Transportation**  
[www.fmcsa.dot.gov](http://www.fmcsa.dot.gov)

## How to Find the Responsible Carrier and Correct U.S. DOT Number

**EXAMPLE 1:** John Smith owns his own truck tractor, operating under John Smith Trucking. He contracts with White Manufacturing to take one of its trailers loaded with its goods from New York to Los Angeles.

**Who is the Motor Carrier:**  
A. John Smith?  
B. White Manufacturing?

➔

**John Smith is the motor carrier, because he is the entity that has agreed to carry this particular load.**

**EXAMPLE 2:** John Smith, driving his truck tractor, utilizes a cargo broker, K&S Trucking, to obtain goods from Intermodal Inc. shipping company for his return trip back to New York.

**Who is the Motor Carrier:**  
A. John Smith?  
B. K&S Trucking?  
C. Intermodal Inc.?

➔

**John Smith is the motor carrier, because K&S transferred the responsibility of the load to John Smith.**

---

**EXAMPLE 3:** John Smith, driving his truck tractor, leases his services to Polyester Chemical Company. Polyester directs Smith to deliver a semi-trailer from New York to St. Louis.

**Who is the Motor Carrier:**  
A. John Smith?  
B. Polyester?

➔

**The lease agreement between Polyester and Mr. Smith makes Polyester the motor carrier responsible for the load.**

**EXAMPLE 4:** John Smith is driving a tractor/semi-trailer owned and operated by ABC Trucking.

**Who is the Motor Carrier:**  
A. John Smith?  
B. ABC Trucking?

➔

**ABC Trucking is the motor carrier. John Smith is just a driver for ABC Trucking.**

---

**EXAMPLE 5:** John Smith is driving a tractor owned by ABC Trucking, which has been leased to XYZ Trucking. XYZ uses the tractor to pull XYZ trailers in its regular shipping service.

**Who is the Motor Carrier:**  
A. John Smith?  
B. ABC Trucking?  
C. XYZ Trucking?

➔

**In this case XYZ is the motor carrier, because XYZ is directing the carrying of the load.**

**Federal Motor Carrier Safety Administration**



**U.S. Department of Transportation**  
[www.fmcsa.dot.gov](http://www.fmcsa.dot.gov)

## GUIDELINES FOR IDENTIFYING HAZARDOUS MATERIALS BY SHIPPING PAPERS

### Accessibility:

Shipping papers and emergency response information should be within the driver's reach while he/she is restrained in the lap belt of the vehicle and either readily visible to a person entering the driver's compartment or in a holder which is mounted to the inside of the driver's door.

### Hazardous Material Shipping Paper Description:

The commercial motor vehicle may be transporting more than one hazardous material. The first hazardous material listed on the shipping papers under "Proper Shipping Name" must be shown in *Section 7G - Commercial Motor Vehicle*. The listing in the shipping papers will look similar to the following example:

Proper Shipping Name	Hazard Class Division	Identification Number	PG	Quantity
Acetone	3	UN1090	II	55 gals
Petroleum Gases, Liquefied	2.1	UN1075		500 lbs

# APPENDIX E

## Classifying and Locating Crashes

The examples below are of fictitious locations, regardless of any similarity to Missouri roadways.

### NON-INTERSECTION CRASHES

Example #1:

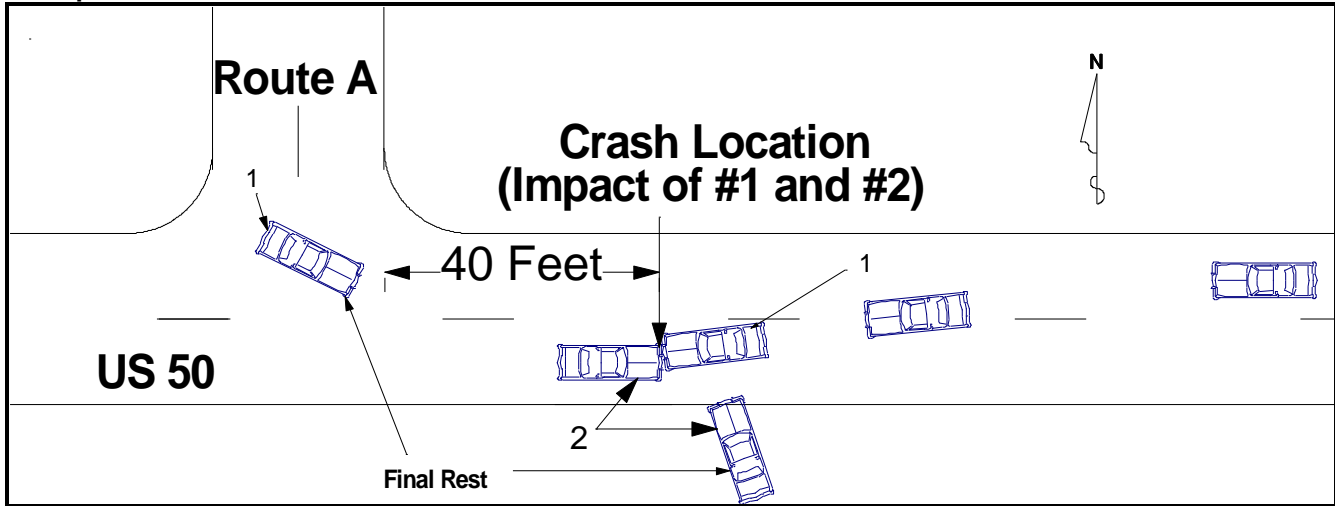

This crash is classified (*Section 1 - Crash Type*) as being a collision "On Roadway" with a "Motor Vehicle in Transport" because the **first harmful event** occurred on the roadway when the two vehicles struck headon. The *Directional Analysis* shows "Front to Front" because the front of one vehicle struck the front of the other.

CRASH TYPE	ROADWAY	NON-COLLISION	COLLISION INVOLVING	DIRECTIONAL ANALYSIS FOR IMPACT WITH MOTOR VEHICLE
<input checked="" type="checkbox"/> On Roadway <input type="checkbox"/> Off Roadway	<input type="checkbox"/> Overturning <input type="checkbox"/> Fire / Explosion <input type="checkbox"/> Immersion <input type="checkbox"/> Jackknife	<input type="checkbox"/> Fell/Jumped From MV <input type="checkbox"/> Cargo / Equip Loss / Shift <input type="checkbox"/> Other Non-Collision	<input type="checkbox"/> Animal <input type="checkbox"/> Pedalcycle <input type="checkbox"/> Fixed Object <input type="checkbox"/> Other Object <input type="checkbox"/> Pedestrian	<input checked="" type="checkbox"/> Front to Front <input type="checkbox"/> Front to Rear <input type="checkbox"/> Rear to Rear <input type="checkbox"/> Rear to Side <input type="checkbox"/> Angle <input type="checkbox"/> Sideswipe (Same Dir.) <input type="checkbox"/> Sideswipe (Opp. Dir.) <input type="checkbox"/> Falling / Shifting Cargo (Set in motion by MV) <input type="checkbox"/> Other (Explain)
		<input type="checkbox"/> Railway Vehicle <input type="checkbox"/> Animal Drawn Veh / Animal Ridden Trans. <input checked="" type="checkbox"/> Motor Vehicle in Transport <input type="checkbox"/> Parked Motor Vehicle <input type="checkbox"/> Working Motor Vehicle	<input type="checkbox"/> Other (Explain)	

This crash is located (*Section 2 - Location*) where the two vehicles struck headon (first harmful event), which is in the eastbound lane of US 50, 40 Feet After RT A. The direction of the intersecting roadway (Int. Dir.) is "N" (northbound lane) because the location of the crash was measured to the northbound lane of Route A.

ON US 50		RDWY. DIR. E	DISTANCE FROM 40 Feet	LOCATION <input checked="" type="checkbox"/> After <input type="checkbox"/> Before <input type="checkbox"/> At	INTERSECTING RT A
SPEED LIMIT 60	ROAD MAINTAINED BY <input checked="" type="checkbox"/> State <input type="checkbox"/> County <input type="checkbox"/> Municipal <input type="checkbox"/> Private Property <input type="checkbox"/> Other				SPEED LIMIT NA INT. DIR. N GEO - CODE NA
TRAFFICWAY <input type="checkbox"/> One-Way <input checked="" type="checkbox"/> Two-Way; Not Divided <input type="checkbox"/> Two-Way; Divided; Unprotected Median <input type="checkbox"/> Other <input type="checkbox"/> Two-Way; Not Divided; Continuous Center Turn Lane <input type="checkbox"/> Two-Way; Divided; Positive Median Barrier <input type="checkbox"/> Unknown			ROAD ALIGNMENT <input checked="" type="checkbox"/> Straight <input type="checkbox"/> Curve <input type="checkbox"/> Unknown (Explain)		ROAD PROFILE <input checked="" type="checkbox"/> Level <input type="checkbox"/> Downhill <input type="checkbox"/> Dip <input type="checkbox"/> Uphill <input type="checkbox"/> Hillcrest <input type="checkbox"/> Unknown (Explain)
INTERSECTION TYPE <input checked="" type="checkbox"/> NA <input type="checkbox"/> 4-way Intersection <input type="checkbox"/> Y-Intersection <input type="checkbox"/> 5-way / More <input type="checkbox"/> Unknown (Explain) <input type="checkbox"/> T-Intersection <input type="checkbox"/> Roundabout <input type="checkbox"/> Other (Explain)			ROAD CONDITION <input checked="" type="checkbox"/> Dry <input type="checkbox"/> Snow <input type="checkbox"/> Slush <input type="checkbox"/> Standing Water <input type="checkbox"/> Sand / Gravel <input type="checkbox"/> Unknown (Explain) <input type="checkbox"/> Wet <input type="checkbox"/> Ice / Frost <input type="checkbox"/> Mud / Dirt <input type="checkbox"/> Moving Water <input type="checkbox"/> Other (Explain)		

The sequence of events (*Section 7C*) for Vehicle #1 is, "Going Straight" (1), "Cross Center of Road (17) and "Collision with MV In Transport" (34). The sequence of events for Vehicle #2 is, "Going Straight" (1), "Collision with MV in Transport" (34), and "Ran Off Roadway - Right" (20).

Vehicle #1:

7C. VEHICLE ACTION / SEQUENCE OF EVENTS CODES				
SEQUENCE OF EVENTS CODES				<input type="checkbox"/> Unknown
1	17	34		

Vehicle #2:

7C. VEHICLE ACTION / SEQUENCE OF EVENTS CODES				
SEQUENCE OF EVENTS CODES				<input type="checkbox"/> Unknown
1	34	20		



**Example #2:**

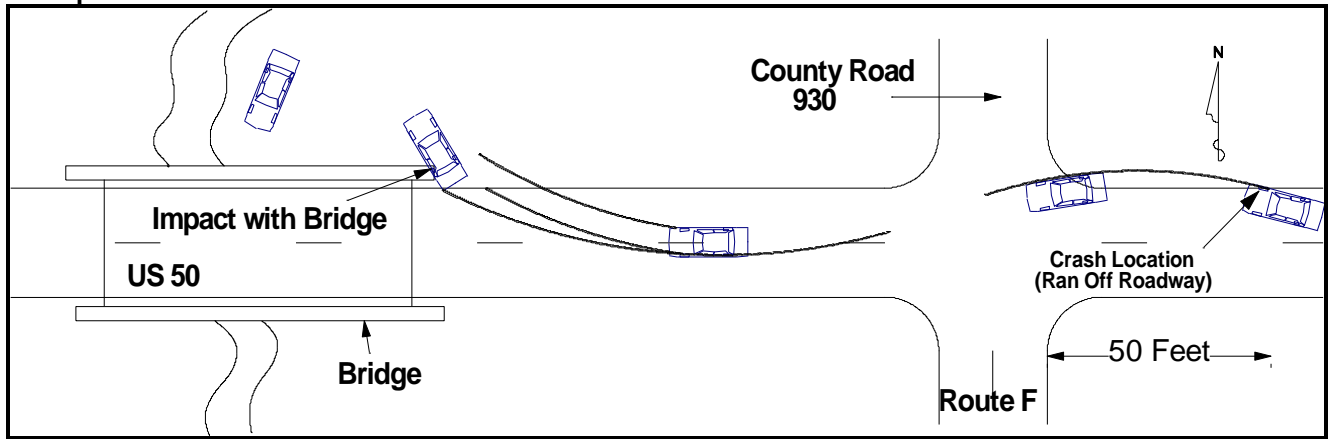

This crash is classified (*Section 1 - Crash Type*) as being a collision "Off Roadway" with a "Fixed Object" because the **first harmful event** was when the vehicle struck the bridge parapet end off the right side of the roadway.

CRASH TYPE	ROADWAY	NON-COLLISION		COLLISION INVOLVING				DIRECTIONAL ANALYSIS FOR IMPACT WITH MOTOR VEHICLE			
	<input type="checkbox"/> On Roadway <input checked="" type="checkbox"/> Off Roadway	<input type="checkbox"/> Overturning <input type="checkbox"/> Fire / Explosion <input type="checkbox"/> Immersion <input type="checkbox"/> Jackknife	<input type="checkbox"/> Fell/Jumped From MV <input type="checkbox"/> Cargo / Equip Loss / Shift <input type="checkbox"/> Other Non-Collision	<input type="checkbox"/> Animal <input checked="" type="checkbox"/> Fixed Object <input type="checkbox"/> Other Object <input type="checkbox"/> Pedestrian	<input type="checkbox"/> Railway Vehicle <input type="checkbox"/> Animal Drawn Veh / Animal Ridden Trans. <input type="checkbox"/> Motor Vehicle in Transport → <input type="checkbox"/> Parked Motor Vehicle → <input type="checkbox"/> Working Motor Vehicle →	<input type="checkbox"/> Front to Front <input type="checkbox"/> Front to Rear <input type="checkbox"/> Rear to Rear <input type="checkbox"/> Rear to Side	<input type="checkbox"/> Angle <input type="checkbox"/> Sideswipe (Same Dir.) <input type="checkbox"/> Sideswipe (Opp. Dir.) <input type="checkbox"/> Falling / Shifting Cargo (Set in motion by MV)	<input type="checkbox"/> Other (Explain) <input type="checkbox"/> Unknown (Explain)			

This crash is located (*Section 2 - Location*) where the vehicle initially ran off the right side of the roadway, rather than where it struck the bridge. This is true even if the vehicle had struck another vehicle head-on where it crossed the centerline. The crash is shown as occurring on US 50 (Roadway Direction - "W"), 50 Feet Before RT F. The direction of the intersecting roadway (Int. Dir.) is "N" (northbound lane) because the location of the crash was measured to the northbound lane of Route F.

ON US 50	RDWY. DIR. W	DISTANCE FROM 50 <input type="checkbox"/> NA Feet Miles	LOCATION <input type="checkbox"/> After <input type="checkbox"/> NA <input checked="" type="checkbox"/> Before <input type="checkbox"/> At	INTERSECTING RT F	SPEED LIMIT NA	INT. DIR. N	GEO - CODE NA
SPEED LIMIT 60	ROAD MAINTAINED BY <input checked="" type="checkbox"/> State <input type="checkbox"/> County <input type="checkbox"/> Municipal <input type="checkbox"/> Private Property <input type="checkbox"/> Other						
TRAFFICWAY <input type="checkbox"/> One-Way <input checked="" type="checkbox"/> Two-Way; Not Divided <input type="checkbox"/> Two-Way; Not Divided; Continuous Center Turn Lane	<input type="checkbox"/> Two-Way; Divided; Unprotected Median <input type="checkbox"/> Two-Way; Divided; Positive Median Barrier <input type="checkbox"/> Other <input type="checkbox"/> Unknown	ROAD ALIGNMENT <input checked="" type="checkbox"/> Straight <input type="checkbox"/> Curve <input type="checkbox"/> Unknown (Explain)	ROAD PROFILE <input checked="" type="checkbox"/> Level <input type="checkbox"/> Downhill <input type="checkbox"/> Dip <input type="checkbox"/> Uphill <input type="checkbox"/> Hillcrest <input type="checkbox"/> Unknown (Explain)				
INTERSECTION TYPE <input type="checkbox"/> 4-way Intersection <input type="checkbox"/> T-Intersection	<input checked="" type="checkbox"/> NA <input type="checkbox"/> Y-Intersection <input type="checkbox"/> 5-way / More <input type="checkbox"/> Roundabout <input type="checkbox"/> Other (Explain)	ROAD CONDITION <input checked="" type="checkbox"/> Dry <input type="checkbox"/> Snow <input type="checkbox"/> Slush <input type="checkbox"/> Standing Water <input type="checkbox"/> Wet <input type="checkbox"/> Ice / Frost <input type="checkbox"/> Mud / Dirt <input type="checkbox"/> Moving Water <input type="checkbox"/> Sand / Gravel <input type="checkbox"/> Unknown (Explain)					

The sequence of events (*Section 7C*) is "Going Straight" (1), "Ran Off Roadway - Right" (20), "Returned to Roadway" (29), "Cross Center of Road" (17), "Ran Off Roadway - Right" (20), and then "Collision Inv. Fixed Object" (36). "Bridge Parapet End" (37) is shown in the "Fixed Object" field.

7C. VEHICLE ACTION / SEQUENCE OF EVENTS CODES <input type="checkbox"/> Additional Codes Listed in Narrative (See Codes in Section 8)		ANIMAL CODE(S)	FIXED OBJECT CODE(S)
SEQUENCE OF EVENTS CODES	<input type="checkbox"/> Unknown		
1 20 29 17 20 36			37

**Example #3:**

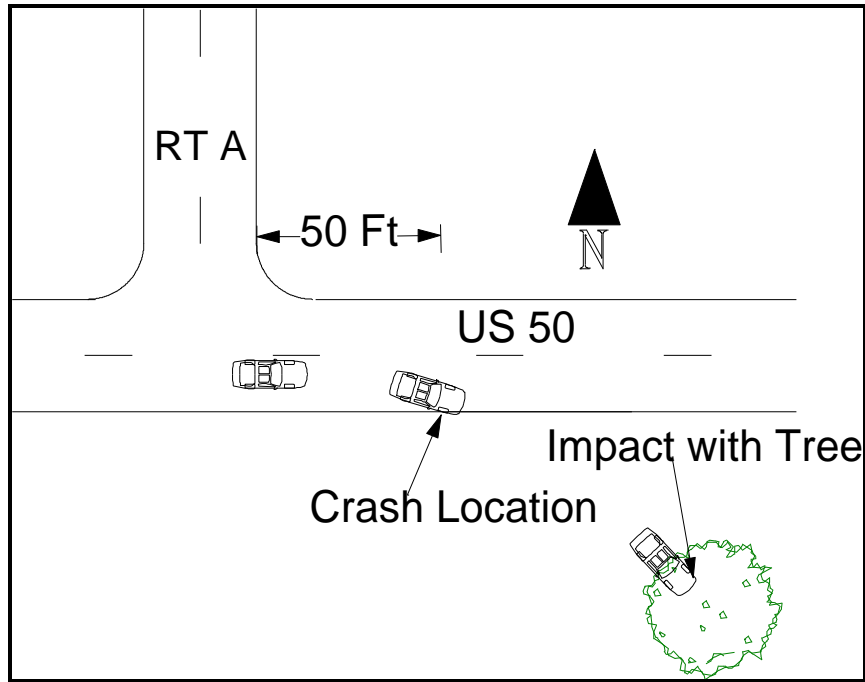

This crash is classified (*Section 1 - Crash Type*) as being a collision "Off Roadway" with a "Fixed Object" because the **first harmful event** was when the vehicle struck the tree off of the roadway.

CRASH TYPE	ROADWAY	NON-COLLISION	COLLISION INVOLVING		DIRECTIONAL ANALYSIS FOR IMPACT WITH MOTOR VEHICLE		
	<input type="checkbox"/> On Roadway <input checked="" type="checkbox"/> Off Roadway	<input type="checkbox"/> Overtuning <input type="checkbox"/> Fire / Explosion <input type="checkbox"/> Immersion <input type="checkbox"/> Jackknife	<input type="checkbox"/> Fell/Jumped From MV <input type="checkbox"/> Cargo / Equip Loss / Shift <input type="checkbox"/> Other Non-Collision	<input type="checkbox"/> Animal <input type="checkbox"/> Pedalcycle <input checked="" type="checkbox"/> Fixed Object <input type="checkbox"/> Other Object <input type="checkbox"/> Pedestrian	<input type="checkbox"/> Railway Vehicle <input type="checkbox"/> Animal Drawn Veh / Animal Ridden Trans. <input type="checkbox"/> Motor Vehicle in Transport <input type="checkbox"/> Parked Motor Vehicle <input type="checkbox"/> Working Motor Vehicle	<input type="checkbox"/> Front to Front <input type="checkbox"/> Front to Rear <input type="checkbox"/> Rear to Rear <input type="checkbox"/> Rear to Side	<input type="checkbox"/> Angle <input type="checkbox"/> Sideswipe (Same Dir.) <input type="checkbox"/> Sideswipe (Opp. Dir.) <input type="checkbox"/> Falling / Shifting Cargo (Set in motion by MV)

The crash is located (*Section 2 - Location*) where the vehicle left the main traveled portion of the roadway. In this case, the location is shown as being on US 50 (Roadway Direction - "E"), 50 Feet After RT A. The direction of the intersecting roadway (Int. Dir.) is "N" (northbound lane) because the location of the crash was measured to the northbound lane of Route A.

ON US 50	RDWY. DIR. E	DISTANCE FROM 50 Feet	LOCATION <input checked="" type="checkbox"/> After <input type="checkbox"/> Before <input type="checkbox"/> At	INTERSECTING RT A
SPEED LIMIT 60	ROAD MAINTAINED BY <input checked="" type="checkbox"/> State <input type="checkbox"/> County <input type="checkbox"/> Municipal <input type="checkbox"/> Private Property <input type="checkbox"/> Other	<input type="checkbox"/> NA	<input type="checkbox"/> NA	SPEED LIMIT NA
TRAFFICWAY <input type="checkbox"/> One-Way <input checked="" type="checkbox"/> Two-Way; Not Divided <input type="checkbox"/> Two-Way; Divided; Unprotected Median <input type="checkbox"/> Other <input type="checkbox"/> Two-Way; Not Divided; Continuous Center Turn Lane <input type="checkbox"/> Two-Way; Divided; Positive Median Barrier <input type="checkbox"/> Unknown		ROAD ALIGNMENT <input checked="" type="checkbox"/> Straight <input type="checkbox"/> Curve <input type="checkbox"/> Unknown (Explain)		ROAD PROFILE <input checked="" type="checkbox"/> Level <input type="checkbox"/> Downhill <input type="checkbox"/> Dip <input type="checkbox"/> Uphill <input type="checkbox"/> Hillcrest <input type="checkbox"/> Unknown (Explain)
INTERSECTION TYPE <input type="checkbox"/> 4-way Intersection <input type="checkbox"/> Y-Intersection <input type="checkbox"/> 5-way / More <input type="checkbox"/> Unknown (Explain) <input type="checkbox"/> T-Intersection <input type="checkbox"/> Roundabout <input type="checkbox"/> Other (Explain)		ROAD CONDITION <input checked="" type="checkbox"/> Dry <input type="checkbox"/> Snow <input type="checkbox"/> Slush <input type="checkbox"/> Standing Water <input type="checkbox"/> Sand / Gravel <input type="checkbox"/> Unknown (Explain) <input type="checkbox"/> Wet <input type="checkbox"/> Ice / Frost <input type="checkbox"/> Mud / Dirt <input type="checkbox"/> Moving Water <input type="checkbox"/> Other (Explain)		

The Sequence of Events (*Section 7C*) is "Going Straight" (1), "Ran Off Roadway - Right" (20) and then "Collision Inv. Fixed Object" (36). "Tree / Stump (Standing)" (20) is shown in the "Fixed Object" field.

7C. VEHICLE ACTION / SEQUENCE OF EVENTS CODES <input type="checkbox"/> Additional Codes Listed in Narrative (See Codes in Section 8)			
SEQUENCE OF EVENTS CODES 1 20 36	<input type="checkbox"/> Unknown	ANIMAL CODE(S)	FIXED OBJECT CODE(S) 20

**Example #4:**

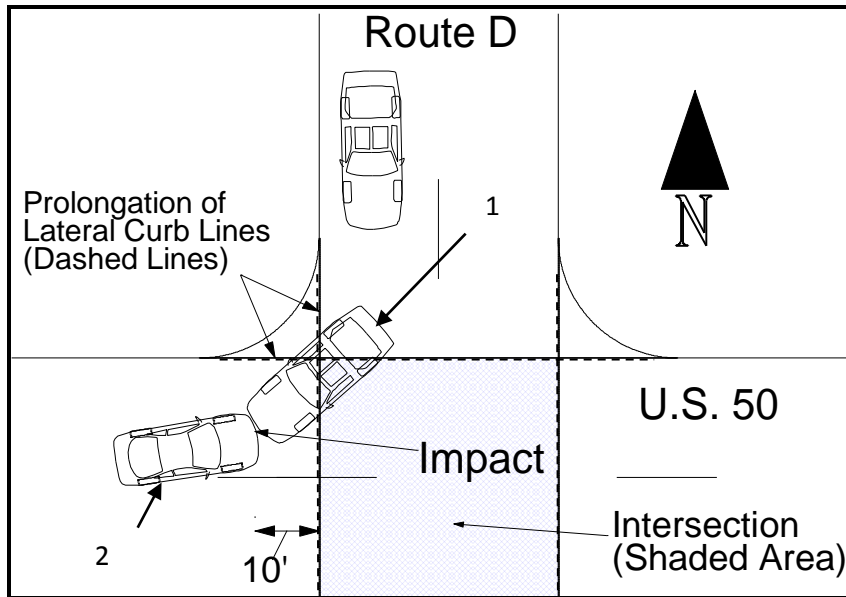

This crash is classified (*Section 1 - Crash Type*) as being a collision "On Roadway" with a "Motor Vehicle in Transport" because the **first harmful event** occurred on the roadway when the two vehicles struck. The *Directional Analysis* shows "Front to Front" because the front of one vehicle struck the front of the other.

CRASH TYPE	ROADWAY	NON-COLLISION	COLLISION INVOLVING		DIRECTIONAL ANALYSIS FOR IMPACT WITH MOTOR VEHICLE		
	<input checked="" type="checkbox"/> On Roadway <input type="checkbox"/> Off Roadway	<input type="checkbox"/> Overturning <input type="checkbox"/> Fire / Explosion <input type="checkbox"/> Immersion <input type="checkbox"/> Jackknife	<input type="checkbox"/> Fell/Jumped From MV <input type="checkbox"/> Cargo / Equip Loss / Shift <input type="checkbox"/> Other Non-Collision	<input type="checkbox"/> Animal <input type="checkbox"/> Pedalcycle <input type="checkbox"/> Fixed Object <input type="checkbox"/> Other Object <input type="checkbox"/> Pedestrian	<input type="checkbox"/> Railway Vehicle <input type="checkbox"/> Animal Drawn Veh / Animal Ridden Trans. <input checked="" type="checkbox"/> Motor Vehicle in Transport <input type="checkbox"/> Parked Motor Vehicle <input type="checkbox"/> Working Motor Vehicle	<input checked="" type="checkbox"/> Front to Front <input type="checkbox"/> Front to Rear <input type="checkbox"/> Rear to Rear <input type="checkbox"/> Rear to Side	<input type="checkbox"/> Angle <input type="checkbox"/> Sideswipe (Same Dir.) <input type="checkbox"/> Sideswipe (Opp. Dir.) <input type="checkbox"/> Falling / Shifting Cargo (Set in motion by MV)

The crash is located (*Section 2 - Location*) outside the intersection. The location is shown as being on US 50 (Roadway Direction - "W"), 10 Feet After RT D. The direction of the intersecting roadway (Int. Dir.) is "S" (southbound lane) because the location of the crash was measured to the southbound lane of Route D.

ON US 50	RDWY. DIR. W	DISTANCE FROM 10 Feet	LOCATION <input checked="" type="checkbox"/> After <input type="checkbox"/> Before <input type="checkbox"/> At	INTERSECTING RT D
SPEED LIMIT 60	ROAD MAINTAINED BY <input checked="" type="checkbox"/> State <input type="checkbox"/> County <input type="checkbox"/> Municipal <input type="checkbox"/> Private Property <input type="checkbox"/> Other	<input type="checkbox"/> NA	<input type="checkbox"/> NA	SPEED LIMIT NA
TRAFFICWAY <input type="checkbox"/> One-Way <input checked="" type="checkbox"/> Two-Way; Not Divided <input type="checkbox"/> Two-Way; Divided; Unprotected Median <input type="checkbox"/> Two-Way; Not Divided; Continuous Center Turn Lane <input type="checkbox"/> Two-Way; Divided; Positive Median Barrier <input type="checkbox"/> Other <input type="checkbox"/> Unknown	ROAD ALIGNMENT <input checked="" type="checkbox"/> Straight <input type="checkbox"/> Curve <input type="checkbox"/> Unknown (Explain)	ROAD PROFILE <input checked="" type="checkbox"/> Level <input type="checkbox"/> Downhill <input type="checkbox"/> Dip <input type="checkbox"/> Uphill <input type="checkbox"/> Hillcrest <input type="checkbox"/> Unknown (Explain)	GEO - CODE NA	
INTERSECTION TYPE <input type="checkbox"/> 4-way Intersection <input type="checkbox"/> Y-Intersection <input type="checkbox"/> 5-way / More <input type="checkbox"/> Unknown (Explain) <input checked="" type="checkbox"/> NA <input type="checkbox"/> T-Intersection <input type="checkbox"/> Roundabout <input type="checkbox"/> Other (Explain)	ROAD CONDITION <input checked="" type="checkbox"/> Dry <input type="checkbox"/> Snow <input type="checkbox"/> Slush <input type="checkbox"/> Standing Water <input type="checkbox"/> Sand / Gravel <input type="checkbox"/> Unknown (Explain) <input type="checkbox"/> Wet <input type="checkbox"/> Ice / Frost <input type="checkbox"/> Mud / Dirt <input type="checkbox"/> Moving Water <input type="checkbox"/> Other (Explain)			

The sequence of events (*Section 7C*) for Vehicle #1 is (assuming it stopped before turning right) "Start in Traffic" (9), "Making Right Turn" (3), and Collision Inv. MV in Transport" (34). The sequence of events for Vehicle #2 is "Going Straight" (1), "Cross Center of Road" (17) and "Collision Inv. MV in Transport" (34).

Vehicle #1:

7C. VEHICLE ACTION / SEQUENCE OF EVENTS CODES				
SEQUENCE OF EVENTS CODES <input type="checkbox"/> Unknown				
9	3	34		

Vehicle #2:

7C. VEHICLE ACTION / SEQUENCE OF EVENTS CODES				
SEQUENCE OF EVENTS CODES <input type="checkbox"/> Unknown				
1	17	34		

In this case, the *Compass Direction* under *Section 6 - Collision Diagram* should reflect vehicle #1 as "S" (south) and vehicle #2 as "E" (east).

**Example #5:**

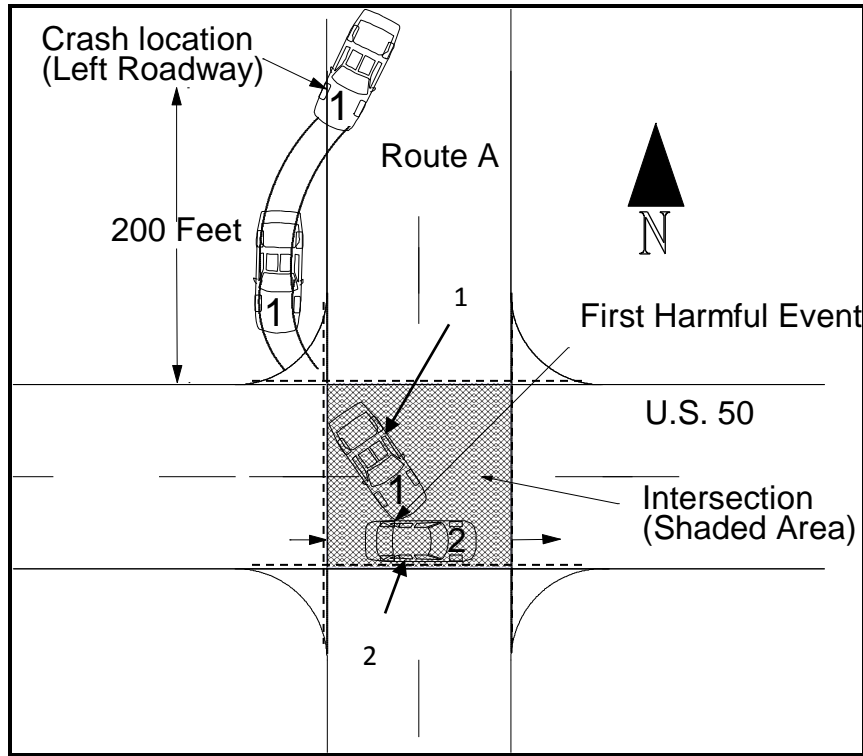

This crash is classified (*Section 1 - Crash Type*) as being a collision "On Roadway" with a "Motor Vehicle in Transport" because the **first harmful event** occurred on the roadway when the two vehicles struck. The *Directional Analysis* shows "Angle" because the front of vehicle #1 struck the side of vehicle #2.

CRASH TYPE	ROADWAY	NON-COLLISION	COLLISION INVOLVING		DIRECTIONAL ANALYSIS FOR IMPACT WITH MOTOR VEHICLE			
	<input checked="" type="checkbox"/> On Roadway <input type="checkbox"/> Off Roadway	<input type="checkbox"/> Overturning <input type="checkbox"/> Fire / Explosion <input type="checkbox"/> Immersion <input type="checkbox"/> Jackknife	<input type="checkbox"/> Fell/Jumped From MV <input type="checkbox"/> Cargo / Equip Loss / Shift <input type="checkbox"/> Other Non-Collision	<input type="checkbox"/> Animal <input type="checkbox"/> Pedalcycle <input type="checkbox"/> Fixed Object <input type="checkbox"/> Other Object <input type="checkbox"/> Pedestrian	<input type="checkbox"/> Railway Vehicle <input type="checkbox"/> Animal Drawn Veh / Animal Ridden Trans. <input checked="" type="checkbox"/> Motor Vehicle in Transport <input type="checkbox"/> Parked Motor Vehicle <input type="checkbox"/> Working Motor Vehicle	<input type="checkbox"/> Front to Front <input type="checkbox"/> Front to Rear <input type="checkbox"/> Rear to Rear <input type="checkbox"/> Rear to Side	<input checked="" type="checkbox"/> Angle <input type="checkbox"/> Sideswipe (Same Dir.) <input type="checkbox"/> Sideswipe (Opp. Dir.) <input type="checkbox"/> Falling / Shifting Cargo (Set in motion by MV)	<input type="checkbox"/> Other (Explain) <input type="checkbox"/> Unknown (Explain)

The crash is located (*Section 2 - Location*) outside the intersection where Vehicle #1 first left the roadway (even though the vehicle returned to and the first harmful event was on the roadway). The location is shown as being on RT A (Roadway Direction - "S"), 200 Feet Before US 50. The direction of the intersecting roadway (Int. Dir.) is "W" (westbound lanes) because the location was measured to the westbound lane of US 50.

ON RT A	RDWY. DIR. S	DISTANCE FROM 200 Feet	LOCATION After	INTERSECTING US 50
SPEED LIMIT 55	ROAD MAINTAINED BY State	200 Feet	Before	SPEED LIMIT NA
TRAFFICWAY Two-Way; Not Divided	ROAD ALIGNMENT Straight	ROAD PROFILE Level	INT. DIR. W	GEO - CODE NA
INTERSECTION TYPE NA	ROAD CONDITION Dry	Standing Water		

The sequence of events (*Section 7C*) for Vehicle #1 is "Going Straight" (1), "Ran Off Roadway - Right" (20), "Returned to Roadway" (29), and "Collision Inv. MV in Transport" (34). The sequence of events for Vehicle #2 is "Going Straight" (1), and "Collision Inv. MV in Transport" (34).

Vehicle #1:

7C. VEHICLE ACTION / SEQUENCE OF EVENTS CODES				
SEQUENCE OF EVENTS CODES	<input type="checkbox"/> Unknown			
1   20   29   34				

Vehicle #2:

7C. VEHICLE ACTION / SEQUENCE OF EVENTS CODES				
SEQUENCE OF EVENTS CODES	<input type="checkbox"/> Unknown			
1   34				

**Example #6:**

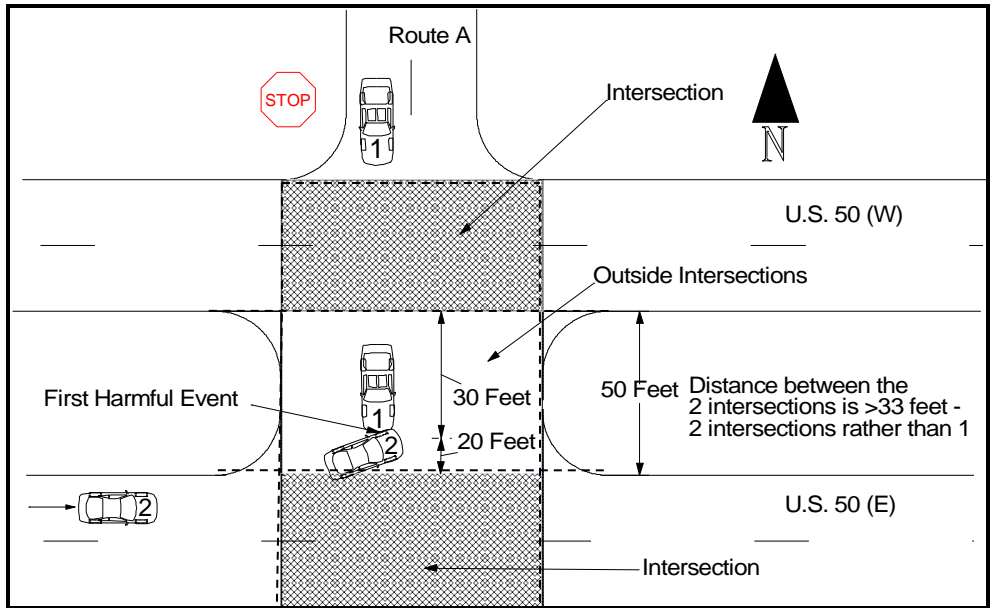

This crash is classified (*Section 1 - Crash Type*) as being a collision "On Roadway" with a "Motor Vehicle in Transport" because the **first harmful event** occurred on the roadway when the two vehicles struck. The *Directional Analysis* shows "Angle" because the front of vehicle #1 struck the side of vehicle #2.

CRASH TYPE	ROADWAY	NON-COLLISION		COLLISION INVOLVING		DIRECTIONAL ANALYSIS FOR IMPACT WITH MOTOR VEHICLE		
	<input checked="" type="checkbox"/> On Roadway <input type="checkbox"/> Off Roadway	<input type="checkbox"/> Overturning <input type="checkbox"/> Fire / Explosion <input type="checkbox"/> Immersion <input type="checkbox"/> Jackknife	<input type="checkbox"/> Fell/Jumped From MV <input type="checkbox"/> Cargo / Equip Loss / Shift <input type="checkbox"/> Other Non-Collision	<input type="checkbox"/> Animal <input type="checkbox"/> Pedalcycle <input type="checkbox"/> Fixed Object <input type="checkbox"/> Other Object <input type="checkbox"/> Pedestrian	<input type="checkbox"/> Railway Vehicle <input type="checkbox"/> Animal Drawn Veh / Animal Ridden Trans. <input checked="" type="checkbox"/> Motor Vehicle in Transport <input type="checkbox"/> Parked Motor Vehicle <input type="checkbox"/> Working Motor Vehicle	<input type="checkbox"/> Front to Front <input type="checkbox"/> Front to Rear <input type="checkbox"/> Rear to Rear <input type="checkbox"/> Rear to Side	<input checked="" type="checkbox"/> Angle <input type="checkbox"/> Sideswipe (Same Dir.) <input type="checkbox"/> Sideswipe (Opp. Dir.) <input type="checkbox"/> Falling / Shifting Cargo (Set in motion by MV)	<input type="checkbox"/> Other (Explain) <input type="checkbox"/> Unknown (Explain)

The east and westbound lanes of US 50 are over 33 feet apart at Route A; therefore, there are two intersections. The crash is located (*Section 2 - Location*) outside the two intersections. The location can be shown on the crash report as on Route A and referenced to either east or westbound US 50.

1. On RT A (Roadway Direction - "S"), 30 Feet After US 50. The direction of the intersecting roadway (Int. Dir.) is shown as "W" (westbound lane).

ON RT A	RDWY. DIR.	DISTANCE FROM	LOCATION	INTERSECTING
	S	30 Feet	<input checked="" type="checkbox"/> After <input type="checkbox"/> Before <input type="checkbox"/> At	US 50
SPEED LIMIT	ROAD MAINTAINED BY			SPEED LIMIT INT. DIR. GEO - CODE
55	<input checked="" type="checkbox"/> State <input type="checkbox"/> County <input type="checkbox"/> Municipal <input type="checkbox"/> Private Property <input type="checkbox"/> Other			NA NA NA
TRAFFICWAY			ROAD ALIGNMENT	ROAD PROFILE
<input type="checkbox"/> One-Way <input checked="" type="checkbox"/> Two-Way; Not Divided <input type="checkbox"/> Two-Way; Divided; Unprotected Median <input type="checkbox"/> Other			<input checked="" type="checkbox"/> Straight <input type="checkbox"/> Curve <input type="checkbox"/> Unknown (Explain)	<input checked="" type="checkbox"/> Level <input type="checkbox"/> Downhill <input type="checkbox"/> Dip <input type="checkbox"/> Uphill <input type="checkbox"/> Hillcrest <input type="checkbox"/> Unknown (Explain)
INTERSECTION TYPE	<input checked="" type="checkbox"/> NA		ROAD CONDITION	
<input type="checkbox"/> 4-way Intersection <input type="checkbox"/> Y-Intersection <input type="checkbox"/> 5-way / More <input type="checkbox"/> Unknown (Explain) <input type="checkbox"/> T-Intersection <input type="checkbox"/> Roundabout <input type="checkbox"/> Other (Explain)			<input checked="" type="checkbox"/> Dry <input type="checkbox"/> Snow <input type="checkbox"/> Slush <input type="checkbox"/> Standing Water <input type="checkbox"/> Sand / Gravel <input type="checkbox"/> Unknown (Explain) <input type="checkbox"/> Wet <input type="checkbox"/> Ice / Frost <input type="checkbox"/> Mud / Dirt <input type="checkbox"/> Moving Water <input type="checkbox"/> Other (Explain)	

2. On RT A (Roadway Direction - "S"), 20 Feet Before US 50. The direction of the intersecting roadway (Int. Dir.) is shown as "E" (eastbound lane).

ON RT A	RDWY. DIR.	DISTANCE FROM	LOCATION	INTERSECTING
	S	20 Feet	<input type="checkbox"/> After <input checked="" type="checkbox"/> Before <input type="checkbox"/> At	US 50
SPEED LIMIT	ROAD MAINTAINED BY			SPEED LIMIT INT. DIR. GEO - CODE
55	<input checked="" type="checkbox"/> State <input type="checkbox"/> County <input type="checkbox"/> Municipal <input type="checkbox"/> Private Property <input type="checkbox"/> Other			NA E NA
TRAFFICWAY			ROAD ALIGNMENT	ROAD PROFILE
<input type="checkbox"/> One-Way <input checked="" type="checkbox"/> Two-Way; Not Divided <input type="checkbox"/> Two-Way; Divided; Unprotected Median <input type="checkbox"/> Other			<input checked="" type="checkbox"/> Straight <input type="checkbox"/> Curve <input type="checkbox"/> Unknown (Explain)	<input checked="" type="checkbox"/> Level <input type="checkbox"/> Downhill <input type="checkbox"/> Dip <input type="checkbox"/> Uphill <input type="checkbox"/> Hillcrest <input type="checkbox"/> Unknown (Explain)
INTERSECTION TYPE	<input checked="" type="checkbox"/> NA		ROAD CONDITION	
<input type="checkbox"/> 4-way Intersection <input type="checkbox"/> Y-Intersection <input type="checkbox"/> 5-way / More <input type="checkbox"/> Unknown (Explain) <input type="checkbox"/> T-Intersection <input type="checkbox"/> Roundabout <input type="checkbox"/> Other (Explain)			<input checked="" type="checkbox"/> Dry <input type="checkbox"/> Snow <input type="checkbox"/> Slush <input type="checkbox"/> Standing Water <input type="checkbox"/> Sand / Gravel <input type="checkbox"/> Unknown (Explain) <input type="checkbox"/> Wet <input type="checkbox"/> Ice / Frost <input type="checkbox"/> Mud / Dirt <input type="checkbox"/> Moving Water <input type="checkbox"/> Other (Explain)	

The sequence of events (*Section 7C*) for Vehicle #1 is "Going Straight" (1) and "Collision Inv. MV in Transport" (34). The sequence of events for Vehicle #2 is "Going Straight" (1), "Making Left Turn" (5), and "Collision Inv. MV in Transport" (34).

Vehicle #1:

7C. VEHICLE ACTION / SEQUENCE OF EVENTS CODES										
SEQUENCE OF EVENTS CODES										
1	34									<input type="checkbox"/> Unknown

Vehicle #2:

7C. VEHICLE ACTION / SEQUENCE OF EVENTS CODES										
SEQUENCE OF EVENTS CODES										
1	5	34								<input type="checkbox"/> Unknown

In this case, the *Compass Direction* under *Section 6 - Collision Diagram* should reflect vehicle #1 as "S" (south) and vehicle #2 as "E" (east).

**Example #7:**

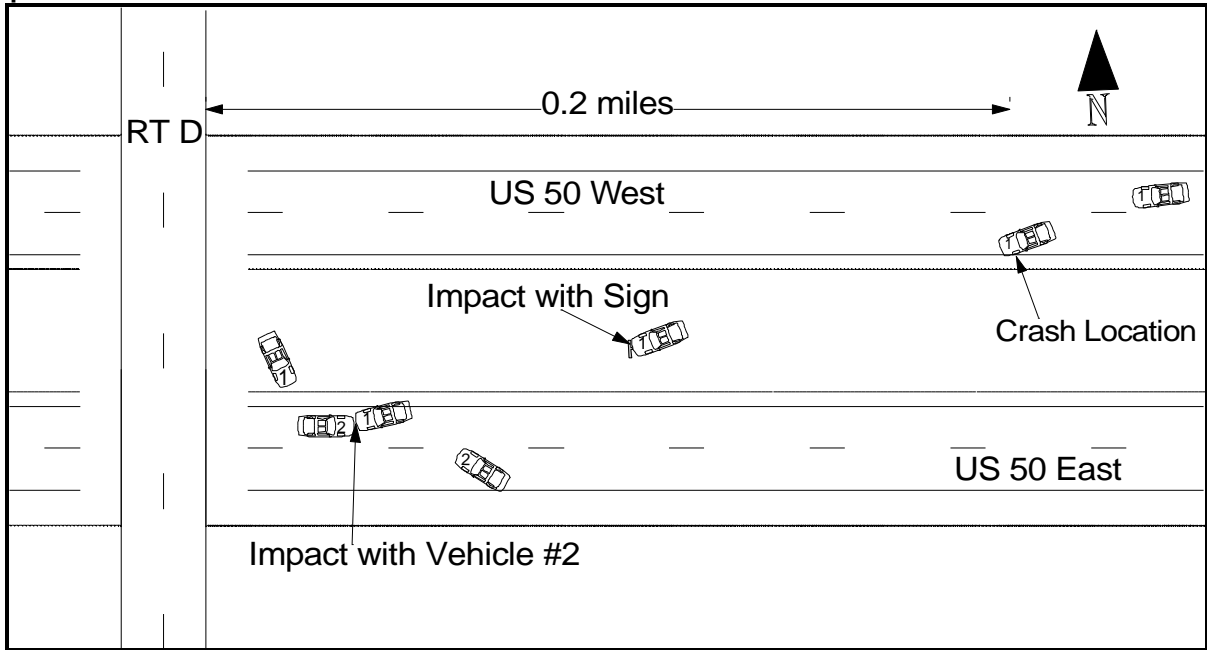

This crash is classified (*Section 1 - Crash Type*) as being a collision "Off Roadway" with a "Fixed Object" because the **first harmful event** was when the westbound vehicle struck the sign in the **median**.

CRASH TYPE	ROADWAY	NON-COLLISION	COLLISION INVOLVING		DIRECTIONAL ANALYSIS FOR IMPACT WITH MOTOR VEHICLE		
	<input type="checkbox"/> On Roadway <input checked="" type="checkbox"/> Off Roadway	<input type="checkbox"/> Overturning <input type="checkbox"/> Fire / Explosion <input type="checkbox"/> Immersion <input type="checkbox"/> Jackknife	<input type="checkbox"/> Fell/Jumped From MV <input type="checkbox"/> Cargo / Equip Loss / Shift <input type="checkbox"/> Other Non-Collision	<input type="checkbox"/> Animal <input type="checkbox"/> Pedalcycle <input checked="" type="checkbox"/> Fixed Object <input type="checkbox"/> Other Object <input type="checkbox"/> Pedestrian	<input type="checkbox"/> Railway Vehicle <input type="checkbox"/> Animal Drawn Veh / Animal Ridden Trans. <input type="checkbox"/> Motor Vehicle in Transport <input type="checkbox"/> Parked Motor Vehicle <input type="checkbox"/> Working Motor Vehicle	<input type="checkbox"/> Front to Front <input type="checkbox"/> Front to Rear <input type="checkbox"/> Rear to Rear <input type="checkbox"/> Rear to Side	<input type="checkbox"/> Angle <input type="checkbox"/> Sideswipe (Same Dir.) <input type="checkbox"/> Sideswipe (Opp. Dir.) <input type="checkbox"/> Falling / Shifting Cargo (Set in motion by MV)

Although the first harmful event in this crash was impact of the westbound vehicle with the sign, the crash is located (*Section 2 - Location*) where the vehicle left the westbound roadway. The location is shown as being on US 50 (Roadway Direction - "W"), 0.2 Miles Before RT D. The direction of the intersecting roadway (Int. Dir.) is "N" (northbound lane) because the location of the crash was measured to the northbound lane of Route D.

ON US 50	RDWY. DIR. W	DISTANCE FROM 0.2 Miles	LOCATION After	INTERSECTING RT D
SPEED LIMIT 65	ROAD MAINTAINED BY <input checked="" type="checkbox"/> State	0.2 Miles	At	SPEED LIMIT NA
TRAFFICWAY <input checked="" type="checkbox"/> Two-Way, Divided; Unprotected Median	Unknown		ROAD ALIGNMENT <input checked="" type="checkbox"/> Straight	ROAD PROFILE <input checked="" type="checkbox"/> Level
INTERSECTION TYPE <input checked="" type="checkbox"/> NA			ROAD CONDITION <input checked="" type="checkbox"/> Dry	

The sequence of events (*Section 7C*) for vehicle #1 is "Going Straight" (1), "Ran Off Roadway - Left" (21), "Collision Inv. Fixed Object" (36), "Cross Median" (16), "Collision Inv. MV In Transport" (34) and then "Ran Off Road - Right" (20). "Highway Traffic Sign Post / Support" (27) is shown in the "Fixed Object" field. The sequence of events for vehicle #2 is "Going Straight" (1) and then "Collision Inv. MV In Transport" (34).

**Vehicle #1:**

7C. VEHICLE ACTION / SEQUENCE OF EVENTS CODES	<input type="checkbox"/> Additional Codes Listed in Narrative (See Codes in Section 8)
SEQUENCE OF EVENTS CODES 1 21 36 16 34 20	ANIMAL CODE(S) FIXED OBJECT CODE(S) 27

**Vehicle #2:**

7C. VEHICLE ACTION / SEQUENCE OF EVENTS CODES	<input type="checkbox"/> Additional Codes Listed in Narrative (See Codes in Section 8)
SEQUENCE OF EVENTS CODES 1 34	ANIMAL CODE(S) FIXED OBJECT CODE(S)

**Example #8:**

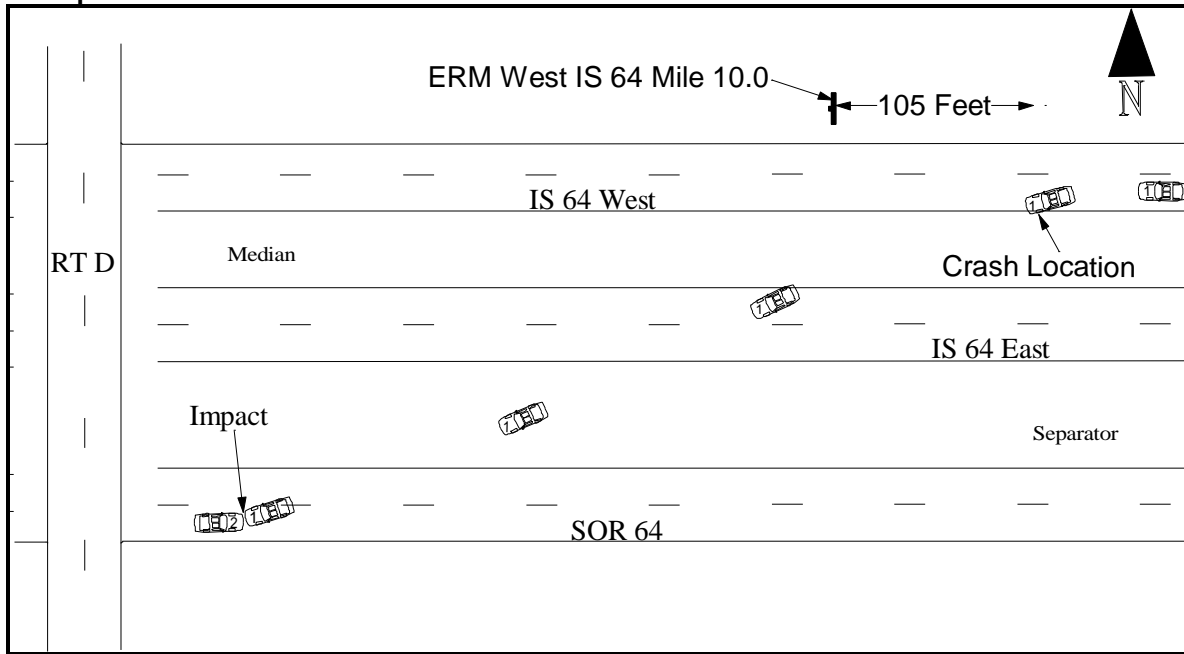

This crash is classified (*Section 1 - Crash Type*) as being a collision "On Roadway" with a "Motor Vehicle In Transport" because the **first harmful event** occurred when the two vehicles struck headon on SOR 64. The *Directional Analysis* shows "Front to Front" because the front of one vehicle struck the front of the other.

CRASH TYPE	<input checked="" type="checkbox"/> On Roadway	<input type="checkbox"/> Non-Collision	<input type="checkbox"/> Collision Involving		DIRECTIONAL ANALYSIS FOR IMPACT WITH MOTOR VEHICLE		
	<input type="checkbox"/> Off Roadway	<input type="checkbox"/> Overturning <input type="checkbox"/> Fire / Explosion <input type="checkbox"/> Immersion <input type="checkbox"/> Jackknife	<input type="checkbox"/> Fell/Jumped From MV <input type="checkbox"/> Cargo / Equip Loss / Shift <input type="checkbox"/> Other Non-Collision	<input type="checkbox"/> Animal <input type="checkbox"/> Pedalcycle <input type="checkbox"/> Fixed Object <input type="checkbox"/> Other Object <input type="checkbox"/> Pedestrian	<input type="checkbox"/> Railway Vehicle <input type="checkbox"/> Animal Drawn Veh / Animal Ridden Trans. <input checked="" type="checkbox"/> Motor Vehicle in Transport <input type="checkbox"/> Parked Motor Vehicle <input type="checkbox"/> Working Motor Vehicle	<input checked="" type="checkbox"/> Front to Front <input type="checkbox"/> Front to Rear <input type="checkbox"/> Rear to Rear <input type="checkbox"/> Rear to Side	<input type="checkbox"/> Angle <input type="checkbox"/> Sideswipe (Same Dir.) <input type="checkbox"/> Sideswipe (Opp. Dir.) <input type="checkbox"/> Falling / Shifting Cargo (Set in motion by MV)

The crash is located (*Section 2 - Location*) where the eastbound vehicle first ran off the left side of the roadway. The location is shown as being on IS 64 (Roadway Direction - "W"), 105 Feet Before **ERM** West IS 64 Mile 10.0. "NA" is entered in the intersecting roadway (Int. Dir.) field because the crash location was measured to an **ERM**.

ON IS 64	RDWY. DIR. W	DISTANCE FROM 105 Feet	LOCATION <input checked="" type="checkbox"/> Before	INTERSECTING ERM West IS 64 Mile 10.0
SPEED LIMIT 70	ROAD MAINTAINED BY <input checked="" type="checkbox"/> State	<input type="checkbox"/> NA	<input type="checkbox"/> After <input type="checkbox"/> NA	SPEED LIMIT NA
TRAFFICWAY <input checked="" type="checkbox"/> Two-Way, Divided; Unprotected Median	<input type="checkbox"/> Unknown	<input type="checkbox"/> NA	<input type="checkbox"/> At	INT. DIR. NA
<input type="checkbox"/> One-Way	<input type="checkbox"/> County	<input type="checkbox"/> NA	<input type="checkbox"/> Unknown (Explain)	GEO - CODE NA
<input type="checkbox"/> Two-Way, Not Divided; Continuous Center Turn Lane	<input type="checkbox"/> Municipal	<input type="checkbox"/> NA	<input type="checkbox"/> Unknown (Explain)	
INTERSECTION TYPE <input checked="" type="checkbox"/> NA	<input type="checkbox"/> Private Property	<input type="checkbox"/> NA	<input type="checkbox"/> Unknown (Explain)	
<input type="checkbox"/> 4-way Intersection	<input type="checkbox"/> Other	<input type="checkbox"/> NA	<input type="checkbox"/> Unknown (Explain)	
<input type="checkbox"/> T-Intersection	<input type="checkbox"/> Unknown (Explain)	<input type="checkbox"/> NA	<input type="checkbox"/> Unknown (Explain)	
	<input type="checkbox"/> Roundabout	<input type="checkbox"/> NA	<input type="checkbox"/> Unknown (Explain)	
	<input type="checkbox"/> Other (Explain)	<input type="checkbox"/> NA	<input type="checkbox"/> Unknown (Explain)	
		<input type="checkbox"/> NA	<input type="checkbox"/> Unknown (Explain)	
		<input type="checkbox"/> NA	<input type="checkbox"/> Unknown (Explain)	
		<input type="checkbox"/> NA	<input type="checkbox"/> Unknown (Explain)	

The sequence of events (*Section 7C*) for vehicle #1 is "Going Straight" (1), "Ran Off Roadway - Left" (21), "Cross Median" (16), "Cross Road" (18), "Cross Separator" (47), and then "Collision Inv. MV In Transport" (34). The sequence of events for vehicle #2 is "Going Straight" (1), and then "Collision Inv. MV in Transport" (34).

Vehicle #1:

7C. VEHICLE ACTION / SEQUENCE OF EVENTS CODES					
SEQUENCE OF EVENTS CODES	<input type="checkbox"/> Unknown				
1	21	16	18	47	34

Vehicle #2:

7C. VEHICLE ACTION / SEQUENCE OF EVENTS CODES					
SEQUENCE OF EVENTS CODES	<input type="checkbox"/> Unknown				
1	34				



# INTERSECTION CRASHES

## Example #1:

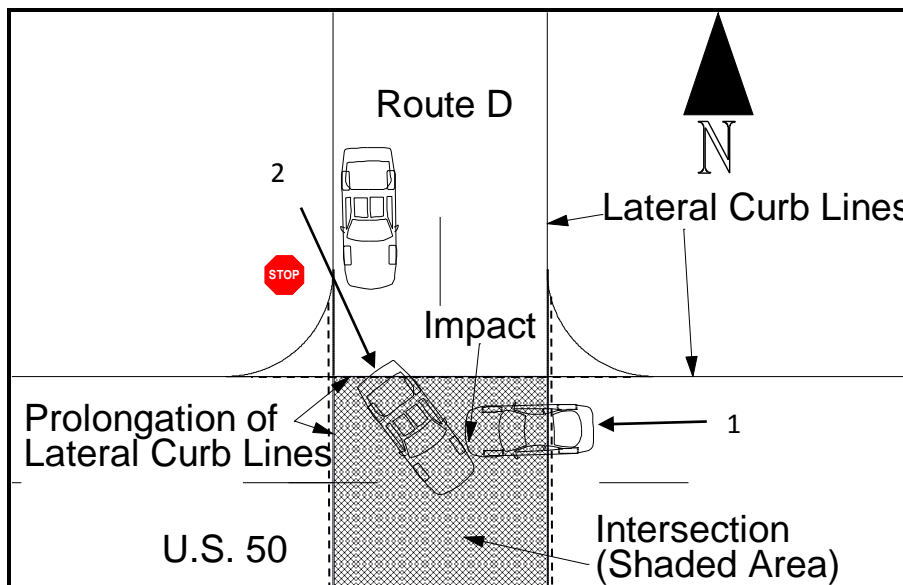

This crash is classified (*Section 1 - Crash Type*) as being a collision "On Roadway" with a "Motor Vehicle in Transport" because the **first harmful event** occurred on the roadway when the two vehicles struck. The *Directional Analysis* shows "Angle" because the front of vehicle #1 struck the side of vehicle #2.

CRASH TYPE	ROADWAY	NON-COLLISION	COLLISION INVOLVING		DIRECTIONAL ANALYSIS FOR IMPACT WITH MOTOR VEHICLE		
	<input checked="" type="checkbox"/> On Roadway <input type="checkbox"/> Off Roadway	<input type="checkbox"/> Overturning <input type="checkbox"/> Fire / Explosion <input type="checkbox"/> Immersion <input type="checkbox"/> Jackknife	<input type="checkbox"/> Fell/Jumped From MV <input type="checkbox"/> Cargo / Equip Loss / Shift <input type="checkbox"/> Other Non-Collision	<input type="checkbox"/> Animal <input type="checkbox"/> Pedalcycle <input type="checkbox"/> Fixed Object <input type="checkbox"/> Other Object <input type="checkbox"/> Pedestrian	<input type="checkbox"/> Railway Vehicle <input type="checkbox"/> Animal Drawn Veh / Animal Ridden Trans. <input checked="" type="checkbox"/> Motor Vehicle in Transport <input type="checkbox"/> Parked Motor Vehicle <input type="checkbox"/> Working Motor Vehicle	<input type="checkbox"/> Front to Front <input type="checkbox"/> Front to Rear <input type="checkbox"/> Rear to Rear <input type="checkbox"/> Rear to Side	<input checked="" type="checkbox"/> Angle <input type="checkbox"/> Sideswipe (Same Dir.) <input type="checkbox"/> Sideswipe (Opp. Dir.) <input type="checkbox"/> Falling / Shifting Cargo (Set in motion by MV)

The crash is located (*Section 2 - Location*) within the intersection where the two vehicles struck. The location can be shown on the crash report on either route within the intersection:

1. On US 50 (Roadway Direction - "E" or "W"), At RT D. The direction of the intersecting roadway (Int. Dir.) can be shown as either "N" (northbound lane) or "S" (southbound lane) because the location of the crash was within the intersection of an undivided roadway. Note: Although there are multiple methods for showing the location on US 50, only one example is provided.

ON US 50	RDWY. DIR. E	DISTANCE FROM NA Feet Miles	LOCATION <input type="checkbox"/> After <input type="checkbox"/> Before <input checked="" type="checkbox"/> At	INTERSECTING RT D	SPEED LIMIT 55	INT. DIR. N	GEO - CODE NA
SPEED LIMIT 60	ROAD MAINTAINED BY <input checked="" type="checkbox"/> State <input type="checkbox"/> County <input type="checkbox"/> Municipal <input type="checkbox"/> Private Property <input type="checkbox"/> Other						
TRAFFICWAY <input type="checkbox"/> One-Way <input type="checkbox"/> Two-Way; Not Divided; Continuous Center Turn Lane	<input checked="" type="checkbox"/> Two-Way; Not Divided	<input type="checkbox"/> Two-Way; Divided; Unprotected Median	ROAD ALIGNMENT <input checked="" type="checkbox"/> Straight <input type="checkbox"/> Curve <input type="checkbox"/> Unknown (Explain)	ROAD PROFILE <input checked="" type="checkbox"/> Level <input type="checkbox"/> Downhill <input type="checkbox"/> Dip <input type="checkbox"/> Uphill <input type="checkbox"/> Hillcrest <input type="checkbox"/> Unknown (Explain)			
INTERSECTION TYPE <input type="checkbox"/> 4-way Intersection <input checked="" type="checkbox"/> T-Intersection	<input type="checkbox"/> Y-Intersection <input type="checkbox"/> Roundabout <input type="checkbox"/> 5-way / More <input type="checkbox"/> Other (Explain)	<input type="checkbox"/> Unknown (Explain)	ROAD CONDITION <input checked="" type="checkbox"/> Dry <input type="checkbox"/> Snow <input type="checkbox"/> Wet <input type="checkbox"/> Ice / Frost	<input type="checkbox"/> Slush <input type="checkbox"/> Standing Water <input type="checkbox"/> Mud / Dirt <input type="checkbox"/> Moving Water	<input type="checkbox"/> Sand / Gravel <input type="checkbox"/> Other (Explain)		

2. On RT D (Roadway Direction - "N" or "S"), At US 50. The direction of the intersecting roadway (Int. Dir.) can be shown as either "E" (eastbound lane) or "W" (westbound lane) because the location of the crash was within the intersection of an undivided roadway. Note: Although there are multiple methods for showing the location on RT D, only one example is provided.

ON RT D		RDWY. DIR. S	DISTANCE FROM <input checked="" type="checkbox"/> NA Feet Miles	LOCATION <input type="checkbox"/> After <input type="checkbox"/> NA <input type="checkbox"/> Before <input checked="" type="checkbox"/> At	INTERSECTING US 50	SPEED LIMIT 60	INT. DIR. W	GEO - CODE NA
SPEED LIMIT 55	ROAD MAINTAINED BY <input checked="" type="checkbox"/> State <input type="checkbox"/> County <input type="checkbox"/> Municipal <input type="checkbox"/> Private Property <input type="checkbox"/> Other			TRAFFICWAY <input type="checkbox"/> One-Way <input checked="" type="checkbox"/> Two-Way; Not Divided <input type="checkbox"/> Two-Way; Divided; Unprotected Median <input type="checkbox"/> Other <input type="checkbox"/> Two-Way; Not Divided; Continuous Center Turn Lane <input type="checkbox"/> Two-Way; Divided; Positive Median Barrier <input type="checkbox"/> Unknown		ROAD ALIGNMENT <input checked="" type="checkbox"/> Straight <input type="checkbox"/> Curve <input type="checkbox"/> Unknown (Explain)		
INTERSECTION TYPE <input type="checkbox"/> 4-way Intersection <input type="checkbox"/> Y-Intersection <input type="checkbox"/> 5-way / More <input type="checkbox"/> Unknown (Explain) <input checked="" type="checkbox"/> T-Intersection <input type="checkbox"/> Roundabout <input type="checkbox"/> Other (Explain)			ROAD PROFILE <input checked="" type="checkbox"/> Level <input type="checkbox"/> Downhill <input type="checkbox"/> Dip <input type="checkbox"/> Uphill <input type="checkbox"/> Hillcrest <input type="checkbox"/> Unknown (Explain)					
ROAD CONDITION <input checked="" type="checkbox"/> Dry <input type="checkbox"/> Snow <input type="checkbox"/> Slush <input type="checkbox"/> Standing Water <input type="checkbox"/> Sand / Gravel <input type="checkbox"/> Unknown (Explain) <input type="checkbox"/> Wet <input type="checkbox"/> Ice / Frost <input type="checkbox"/> Mud / Dirt <input type="checkbox"/> Moving Water <input type="checkbox"/> Other (Explain)								

The sequence of events (*Section 7C*) for Vehicle #1 is "Going Straight" (1) and "Collision Inv. MV in Transport" (34). The sequence of events for Vehicle #2 (assuming it stopped before turning left) is "Start in Traffic" (9), "Making Left Turn" (5), and "Collision Inv. MV in Transport" (34).

Vehicle #1:

7C. VEHICLE ACTION / SEQUENCE OF EVENTS CODES									
SEQUENCE OF EVENTS CODES									
<input type="checkbox"/> Unknown									
1	34								

Vehicle #2:

7C. VEHICLE ACTION / SEQUENCE OF EVENTS CODES									
SEQUENCE OF EVENTS CODES									
<input type="checkbox"/> Unknown									
9	5	34							

In this case, the *Compass Direction* under *Section 6 - Collision Diagram* should reflect vehicle #1 as "W" (west) and vehicle #2 as "S" (south).

**Example #2:**

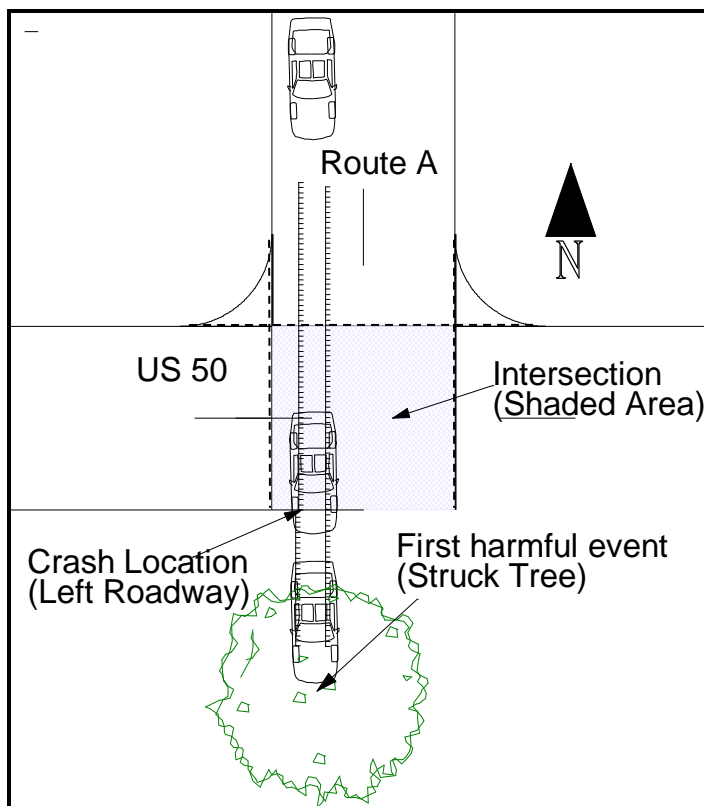

The crash is classified (*Section 1 - Crash Type*) as being a collision "Off Roadway" with a "Fixed Object" because the **first harmful event** occurred when the vehicle struck the tree off the roadway.

CRASH TYPE	ROADWAY	NON-COLLISION	COLLISION INVOLVING		DIRECTIONAL ANALYSIS FOR IMPACT WITH MOTOR VEHICLE		
	<input type="checkbox"/> On Roadway <input checked="" type="checkbox"/> Off Roadway	<input type="checkbox"/> Overturning <input type="checkbox"/> Fire / Explosion <input type="checkbox"/> Immersion <input type="checkbox"/> Jackknife	<input type="checkbox"/> Fell/Jumped From MV <input type="checkbox"/> Cargo / Equip Loss / Shift <input type="checkbox"/> Other Non-Collision	<input type="checkbox"/> Animal <input type="checkbox"/> Pedalcycle <input checked="" type="checkbox"/> Fixed Object <input type="checkbox"/> Other Object <input type="checkbox"/> Pedestrian	<input type="checkbox"/> Railway Vehicle <input type="checkbox"/> Animal Drawn Veh / Animal Ridden Trans. <input type="checkbox"/> Motor Vehicle in Transport <input type="checkbox"/> Parked Motor Vehicle <input type="checkbox"/> Working Motor Vehicle	<input type="checkbox"/> Front to Front <input type="checkbox"/> Front to Rear <input type="checkbox"/> Rear to Rear <input type="checkbox"/> Rear to Side	<input type="checkbox"/> Angle <input type="checkbox"/> Sideswipe (Same Dir.) <input type="checkbox"/> Sideswipe (Opp. Dir.) <input type="checkbox"/> Falling / Shifting Cargo (Set in motion by MV)

The crash is located (*Section 2 - Location*) within the intersection where the vehicle left the roadway. The location can be shown on the crash report on either route within the intersection:

1. On RT A (Roadway Direction - "S") At US 50. The direction of the intersecting roadway (Int. Dir.) can be shown as either "E" (eastbound lane) or "W" (westbound lane) because the location of the crash was within the intersection of an undivided roadway. Note: Although there are two methods for showing the location on RT A, only one example is provided.

ON RT A	RDWY. DIR. S	DISTANCE FROM NA Feet Miles	LOCATION <input type="checkbox"/> After <input type="checkbox"/> NA <input type="checkbox"/> Before <input checked="" type="checkbox"/> At	INTERSECTING US 50
SPEED LIMIT 55	ROAD MAINTAINED BY <input checked="" type="checkbox"/> State <input type="checkbox"/> County <input type="checkbox"/> Municipal <input type="checkbox"/> Private Property <input type="checkbox"/> Other			SPEED LIMIT 60
TRAFFICWAY <input type="checkbox"/> One-Way <input checked="" type="checkbox"/> Two-Way; Not Divided <input type="checkbox"/> Two-Way; Not Divided; Continuous Center Turn Lane	<input type="checkbox"/> Two-Way; Divided; Unprotected Median <input type="checkbox"/> Two-Way; Divided; Positive Median Barrier	<input type="checkbox"/> Other <input type="checkbox"/> Unknown	ROAD ALIGNMENT <input checked="" type="checkbox"/> Straight <input type="checkbox"/> Curve <input type="checkbox"/> Unknown (Explain)	ROAD PROFILE <input checked="" type="checkbox"/> Level <input type="checkbox"/> Downhill <input type="checkbox"/> Dip <input type="checkbox"/> Uphill <input type="checkbox"/> Hillcrest <input type="checkbox"/> Unknown (Explain)
INTERSECTION TYPE <input checked="" type="checkbox"/> T-Intersection <input type="checkbox"/> Roundabout <input type="checkbox"/> Other (Explain)	<input type="checkbox"/> NA <input type="checkbox"/> 4-way Intersection <input type="checkbox"/> Y-Intersection <input type="checkbox"/> 5-way / More <input type="checkbox"/> Unknown (Explain)	ROAD CONDITION <input checked="" type="checkbox"/> Dry <input type="checkbox"/> Snow <input type="checkbox"/> Slush <input type="checkbox"/> Standing Water <input type="checkbox"/> Sand / Gravel <input type="checkbox"/> Unknown (Explain) <input type="checkbox"/> Wet <input type="checkbox"/> Ice / Frost <input type="checkbox"/> Mud / Dirt <input type="checkbox"/> Moving Water <input type="checkbox"/> Other (Explain)		GEO - CODE NA

2. On US 50 (Roadway Direction "E" or "W") At RT A. The direction of the intersecting roadway (Int. Dir.) can be shown as either "S" (southbound lane) or "N" (northbound lane) because the location of the crash was within the intersection of an undivided roadway. Note: Although there are two methods for showing the location on US 50, only one example is provided.

ON US 50		RDWY. DIR. E	DISTANCE FROM <input checked="" type="checkbox"/> NA Feet Miles	LOCATION <input type="checkbox"/> After <input type="checkbox"/> NA <input type="checkbox"/> Before <input checked="" type="checkbox"/> At	INTERSECTING RT A	SPEED LIMIT 55	INT. DIR. S	GEO - CODE
SPEED LIMIT 60	ROAD MAINTAINED BY <input checked="" type="checkbox"/> State <input type="checkbox"/> County <input type="checkbox"/> Municipal <input type="checkbox"/> Private Property <input type="checkbox"/> Other			TRAFFICWAY <input type="checkbox"/> One-Way <input checked="" type="checkbox"/> Two-Way; Not Divided <input type="checkbox"/> Two-Way; Divided; Unprotected Median <input type="checkbox"/> Other <input type="checkbox"/> Two-Way; Not Divided; Continuous Center Turn Lane <input type="checkbox"/> Two-Way; Divided; Positive Median Barrier <input type="checkbox"/> Unknown		ROAD ALIGNMENT <input checked="" type="checkbox"/> Straight <input type="checkbox"/> Curve <input type="checkbox"/> Unknown (Explain)		ROAD PROFILE <input checked="" type="checkbox"/> Level <input type="checkbox"/> Downhill <input type="checkbox"/> Dip <input type="checkbox"/> Uphill <input type="checkbox"/> Hillcrest <input type="checkbox"/> Unknown (Explain)
INTERSECTION TYPE <input type="checkbox"/> NA <input type="checkbox"/> 4-way Intersection <input type="checkbox"/> Y-Intersection <input type="checkbox"/> 5-way / More <input type="checkbox"/> Unknown (Explain) <input checked="" type="checkbox"/> T-Intersection <input type="checkbox"/> Roundabout <input type="checkbox"/> Other (Explain)			ROAD CONDITION <input checked="" type="checkbox"/> Dry <input type="checkbox"/> Snow <input type="checkbox"/> Slush <input type="checkbox"/> Standing Water <input type="checkbox"/> Sand / Gravel <input type="checkbox"/> Unknown (Explain) <input type="checkbox"/> Wet <input type="checkbox"/> Ice / Frost <input type="checkbox"/> Mud / Dirt <input type="checkbox"/> Moving Water <input type="checkbox"/> Other (Explain)					

The sequence of events (*Section 7C*) for the vehicle is "Going Straight" (1), "Skidding/Sliding" (7), "Ran Off Roadway - Other" (46), and "Collision Inv. Fixed Object" (36). "Tree / Stump (Standing)" (20) is shown in the "Fixed Object" field.

7C. VEHICLE ACTION / SEQUENCE OF EVENTS CODES <input type="checkbox"/> Additional Codes Listed in Narrative (See Codes in Section 8)									
SEQUENCE OF EVENTS CODES <input type="checkbox"/> Unknown									
1	7	46	36						20

**Example #3:**

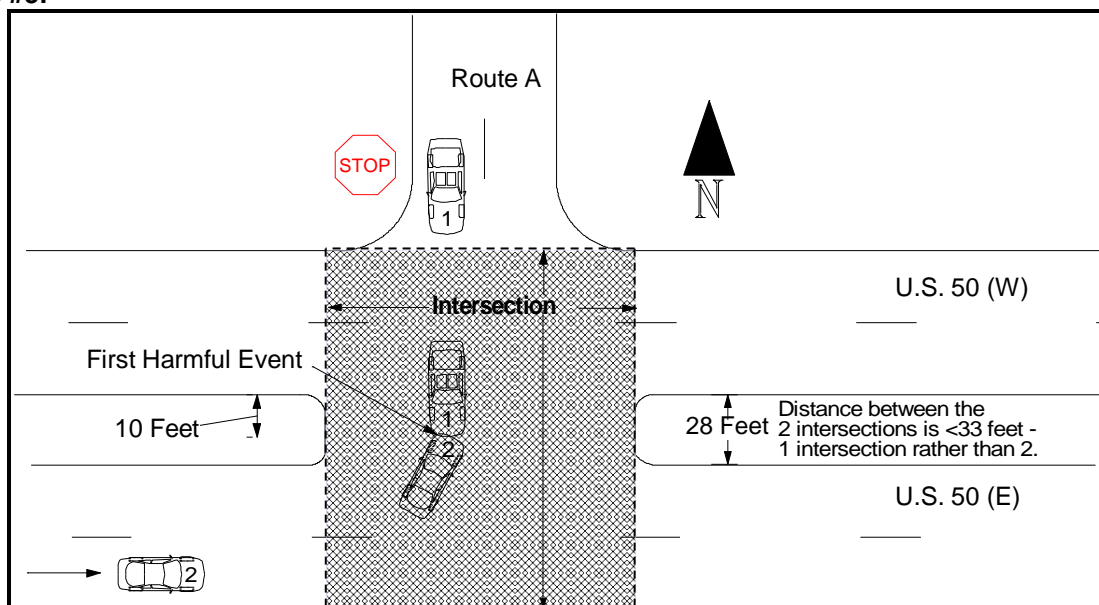

This crash is classified (*Section 1 - Crash Type*) as being a collision "On Roadway" with a "Motor Vehicle in Transport" because the **first harmful event** occurred on the roadway when the two vehicles struck. The *Directional Analysis* shows "Front-to-Front" because the front of vehicle #1 struck the front of vehicle #2.

CRASH TYPE	ROADWAY	NON-COLLISION		COLLISION INVOLVING		DIRECTIONAL ANALYSIS FOR IMPACT WITH MOTOR VEHICLE		
	<input checked="" type="checkbox"/> On Roadway <input type="checkbox"/> Off Roadway	<input type="checkbox"/> Overturning <input type="checkbox"/> Fire / Explosion <input type="checkbox"/> Immersion <input type="checkbox"/> Jackknife	<input type="checkbox"/> Fell/Jumped From MV <input type="checkbox"/> Cargo / Equip Loss / Shift <input type="checkbox"/> Other Non-Collision	<input type="checkbox"/> Animal <input type="checkbox"/> Pedalcycle <input type="checkbox"/> Fixed Object <input type="checkbox"/> Other Object <input type="checkbox"/> Pedestrian	<input type="checkbox"/> Railway Vehicle <input type="checkbox"/> Animal Drawn Veh / Animal Ridden Trans. <input checked="" type="checkbox"/> Motor Vehicle in Transport <input type="checkbox"/> Parked Motor Vehicle <input type="checkbox"/> Working Motor Vehicle	<input checked="" type="checkbox"/> Front to Front <input type="checkbox"/> Front to Rear <input type="checkbox"/> Rear to Rear <input type="checkbox"/> Rear to Side	<input type="checkbox"/> Angle <input type="checkbox"/> Sideswipe (Same Dir.) <input type="checkbox"/> Sideswipe (Opp. Dir.) <input type="checkbox"/> Falling / Shifting Cargo (Set in motion by MV)	<input type="checkbox"/> Other (Explain) <input type="checkbox"/> Unknown (Explain)

The crash is located (*Section 2 - Location*) within the intersection where the two vehicles struck. The location can be shown on the crash report on either route within the intersection:

1. On US 50 (Roadway Direction - "E" or "W"), At RT A. The direction of the intersecting roadway (Int. Dir.) can be shown as either "N" (northbound lane) or "S" (southbound lane) because the location of the crash was within the intersection of a divided roadway with less than 33 feet distance between the lanes. Note: Although there are multiple methods for showing the location on US 50, only one example is provided.

ON US 50	RDWY. DIR. E	DISTANCE FROM <input checked="" type="checkbox"/> NA Feet Miles	LOCATION <input type="checkbox"/> After <input type="checkbox"/> NA <input type="checkbox"/> Before <input checked="" type="checkbox"/> At	INTERSECTING RT A
SPEED LIMIT 65	ROAD MAINTAINED BY <input checked="" type="checkbox"/> State <input type="checkbox"/> County <input type="checkbox"/> Municipal <input type="checkbox"/> Private Property <input type="checkbox"/> Other			SPEED LIMIT 55
TRAFFICWAY <input type="checkbox"/> One-Way <input type="checkbox"/> Two-Way; Not Divided <input checked="" type="checkbox"/> Two-Way; Not Divided; Continuous Center Turn Lane	<input checked="" type="checkbox"/> Two-Way; Divided; Unprotected Median <input type="checkbox"/> Two-Way; Divided; Positive Median Barrier	<input type="checkbox"/> Other <input type="checkbox"/> Unknown	ROAD ALIGNMENT <input checked="" type="checkbox"/> Straight <input type="checkbox"/> Curve <input type="checkbox"/> Unknown (Explain)	ROAD PROFILE <input checked="" type="checkbox"/> Level <input type="checkbox"/> Downhill <input type="checkbox"/> Dip <input type="checkbox"/> Uphill <input type="checkbox"/> Hillcrest <input type="checkbox"/> Unknown (Explain)
INTERSECTION TYPE <input type="checkbox"/> 4-way Intersection <input type="checkbox"/> Y-Intersection <input type="checkbox"/> 5-way / More <input type="checkbox"/> Unknown (Explain) <input checked="" type="checkbox"/> T-Intersection <input type="checkbox"/> Roundabout <input type="checkbox"/> Other (Explain)	ROAD CONDITION <input checked="" type="checkbox"/> Dry <input type="checkbox"/> Snow <input type="checkbox"/> Slush <input type="checkbox"/> Standing Water <input type="checkbox"/> Sand / Gravel <input type="checkbox"/> Unknown (Explain) <input type="checkbox"/> Wet <input type="checkbox"/> Ice / Frost <input type="checkbox"/> Mud / Dirt <input type="checkbox"/> Moving Water <input type="checkbox"/> Other (Explain)			

2. On RT A (Roadway Direction - "N" or "S"), At US 50. The direction of the intersecting roadway (Int. Dir.) can be shown as either "E" (eastbound lane) or "W" (westbound lane) because the location of the crash was within the intersection of a divided roadway with less than 33 feet distance between the lanes. Note: Although there are multiple methods for showing the location on RT A, only one example is provided.

ON RT A		RDWY. DIR. S	DISTANCE FROM <input checked="" type="checkbox"/> NA ____ Feet ____ Miles	LOCATION <input type="checkbox"/> After <input type="checkbox"/> NA <input type="checkbox"/> Before <input checked="" type="checkbox"/> At	INTERSECTING US 50
SPEED LIMIT 55	ROAD MAINTAINED BY <input checked="" type="checkbox"/> State <input type="checkbox"/> County <input type="checkbox"/> Municipal <input type="checkbox"/> Private Property <input type="checkbox"/> Other				SPEED LIMIT 65
TRAFFICWAY <input type="checkbox"/> One-Way <input checked="" type="checkbox"/> Two-Way; Not Divided <input type="checkbox"/> Two-Way; Divided; Unprotected Median <input type="checkbox"/> Other <input type="checkbox"/> Two-Way; Not Divided; Continuous Center Turn Lane <input type="checkbox"/> Two-Way; Divided; Positive Median Barrier <input type="checkbox"/> Unknown			ROAD ALIGNMENT <input checked="" type="checkbox"/> Straight <input type="checkbox"/> Curve <input type="checkbox"/> Unknown (Explain)	ROAD PROFILE <input checked="" type="checkbox"/> Level <input type="checkbox"/> Downhill <input type="checkbox"/> Dip <input type="checkbox"/> Uphill <input type="checkbox"/> Hillcrest <input type="checkbox"/> Unknown (Explain)	
INTERSECTION TYPE <input type="checkbox"/> 4-way Intersection <input type="checkbox"/> Y-Intersection <input type="checkbox"/> 5-way / More <input type="checkbox"/> Unknown (Explain) <input checked="" type="checkbox"/> T-Intersection <input type="checkbox"/> Roundabout <input type="checkbox"/> Other (Explain)			ROAD CONDITION <input checked="" type="checkbox"/> Dry <input type="checkbox"/> Snow <input type="checkbox"/> Slush <input type="checkbox"/> Standing Water <input type="checkbox"/> Sand / Gravel <input type="checkbox"/> Unknown (Explain) <input type="checkbox"/> Wet <input type="checkbox"/> Ice / Frost <input type="checkbox"/> Mud / Dirt <input type="checkbox"/> Moving Water <input type="checkbox"/> Other (Explain)		

The sequence of events (*Section 7C*) for Vehicle #1 is "Going Straight" (1) and "Collision Inv. MV in Transport" (34). The sequence of events for Vehicle #2 is "Going Straight" (1), "Making Left Turn" (5), and "Collision Inv. MV in Transport" (34).

Vehicle #1:

7C. VEHICLE ACTION / SEQUENCE OF EVENTS CODES					
SEQUENCE OF EVENTS CODES					<input type="checkbox"/> Unknown
1	34				

Vehicle #2:

7C. VEHICLE ACTION / SEQUENCE OF EVENTS CODES					
SEQUENCE OF EVENTS CODES					<input type="checkbox"/> Unknown
1	5	34			

In this case, the *Compass Direction* under *Section 6 - Collision Diagram* should reflect vehicle #1 as "S" (south) and vehicle #2 as "E" (east).

**Example #4:**

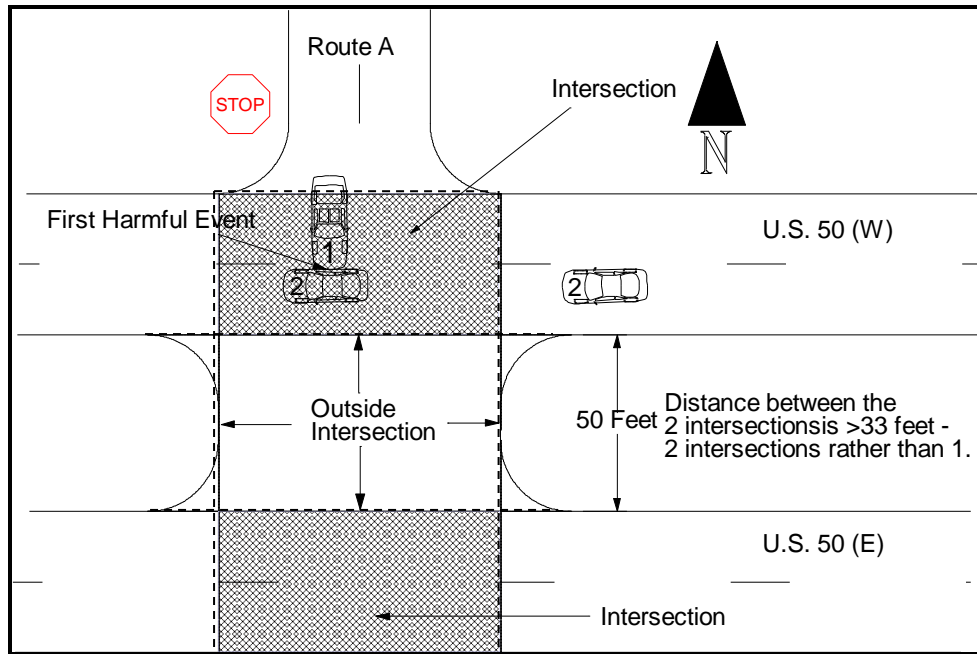

This crash is classified (*Section 1 - Crash Type*) as being a collision "On Roadway" with a "Motor Vehicle in Transport" because the **first harmful event** occurred on the roadway when the two vehicles struck. The *Directional Analysis* shows "Angle" because the front of vehicle #1 struck the side of vehicle #2.

CRASH TYPE	ROADWAY	NON-COLLISION	COLLISION INVOLVING		DIRECTIONAL ANALYSIS FOR IMPACT WITH MOTOR VEHICLE		
	<input checked="" type="checkbox"/> On Roadway <input type="checkbox"/> Off Roadway	<input type="checkbox"/> Overturning <input type="checkbox"/> Fire / Explosion <input type="checkbox"/> Immersion <input type="checkbox"/> Jackknife	<input type="checkbox"/> Fell/Jumped From MV <input type="checkbox"/> Cargo / Equip Loss / Shift <input type="checkbox"/> Other Non-Collision	<input type="checkbox"/> Animal <input type="checkbox"/> Pedalcycle <input type="checkbox"/> Fixed Object <input type="checkbox"/> Other Object <input type="checkbox"/> Pedestrian	<input type="checkbox"/> Railway Vehicle <input type="checkbox"/> Animal Drawn Veh / Animal Ridden Trans. <input checked="" type="checkbox"/> Motor Vehicle in Transport <input type="checkbox"/> Parked Motor Vehicle <input type="checkbox"/> Working Motor Vehicle	<input type="checkbox"/> Front to Front <input type="checkbox"/> Front to Rear <input type="checkbox"/> Rear to Rear <input type="checkbox"/> Rear to Side	<input checked="" type="checkbox"/> Angle <input type="checkbox"/> Sideswipe (Same Dir.) <input type="checkbox"/> Sideswipe (Opp. Dir.) <input type="checkbox"/> Falling / Shifting Cargo (Set in motion by MV)

The east and westbound lanes of US 50 are over 33 feet apart at Route A; therefore, there are two intersections. The crash is located (*Section 2 - Location*) within the intersection where the two vehicles struck. The location can be shown on the crash report on either Route A or westbound US 50:

1. On US 50 (Roadway Direction - "W"), At RT A. The direction of the intersecting roadway (Int. Dir.) is shown as either "N" (northbound lane) or "S" (southbound lane) because the crash was within the intersection. Note: Although there are two methods for showing the location on US 50, only one example is provided.

ON US 50		RDWY. DIR. W	DISTANCE FROM <input checked="" type="checkbox"/> NA Feet Miles	LOCATION <input type="checkbox"/> After <input type="checkbox"/> NA <input type="checkbox"/> Before <input checked="" type="checkbox"/> At	INTERSECTING RT A	SPEED LIMIT 55	INT. DIR. S	GEO - CODE NA
SPEED LIMIT 65	ROAD MAINTAINED BY <input checked="" type="checkbox"/> State <input type="checkbox"/> County <input type="checkbox"/> Municipal <input type="checkbox"/> Private Property <input type="checkbox"/> Other			TRAFFICWAY <input type="checkbox"/> One-Way <input type="checkbox"/> Two-Way; Not Divided <input checked="" type="checkbox"/> Two-Way; Divided; Unprotected Median <input type="checkbox"/> Other <input type="checkbox"/> Two-Way; Not Divided; Continuous Center Turn Lane <input type="checkbox"/> Two-Way; Divided; Positive Median Barrier <input type="checkbox"/> Unknown		ROAD ALIGNMENT <input checked="" type="checkbox"/> Straight <input type="checkbox"/> Curve <input type="checkbox"/> Unknown (Explain)		ROAD PROFILE <input checked="" type="checkbox"/> Level <input type="checkbox"/> Downhill <input type="checkbox"/> Dip <input type="checkbox"/> Uphill <input type="checkbox"/> Hillcrest <input type="checkbox"/> Unknown (Explain)
INTERSECTION TYPE <input checked="" type="checkbox"/> 4-way Intersection <input type="checkbox"/> Y-Intersection <input type="checkbox"/> 5-way / More <input type="checkbox"/> Unknown (Explain) <input type="checkbox"/> T-Intersection <input type="checkbox"/> Roundabout <input type="checkbox"/> Other (Explain)			ROAD CONDITION <input checked="" type="checkbox"/> Dry <input type="checkbox"/> Snow <input type="checkbox"/> Slush <input type="checkbox"/> Standing Water <input type="checkbox"/> Sand / Gravel <input type="checkbox"/> Unknown (Explain) <input type="checkbox"/> Wet <input type="checkbox"/> Ice / Frost <input type="checkbox"/> Mud / Dirt <input type="checkbox"/> Moving Water <input type="checkbox"/> Other (Explain)					

2. On RT A (Roadway Direction - "S"), At US 50. The direction of the intersecting roadway (Int. Dir.) is shown as "W" (westbound lane) because the location of the crash was within the US 50 westbound intersection. Note: The "Roadway Direction" for RT A can be shown as either "N" or "S" because it is within the intersection.

ON RT A		RDWY. DIR. S	DISTANCE FROM <input checked="" type="checkbox"/> NA Feet Miles	LOCATION <input type="checkbox"/> After <input type="checkbox"/> NA <input type="checkbox"/> Before <input checked="" type="checkbox"/> At	INTERSECTING US 50
SPEED LIMIT 55	ROAD MAINTAINED BY <input checked="" type="checkbox"/> State <input type="checkbox"/> County <input type="checkbox"/> Municipal <input type="checkbox"/> Private Property <input type="checkbox"/> Other			SPEED LIMIT 65	
TRAFFICWAY <input type="checkbox"/> One-Way <input checked="" type="checkbox"/> Two-Way; Not Divided <input type="checkbox"/> Two-Way; Divided; Unprotected Median <input type="checkbox"/> Other <input type="checkbox"/> Two-Way; Not Divided; Continuous Center Turn Lane <input type="checkbox"/> Two-Way; Divided; Positive Median Barrier <input type="checkbox"/> Unknown			ROAD ALIGNMENT <input checked="" type="checkbox"/> Straight <input type="checkbox"/> Curve <input type="checkbox"/> Unknown (Explain)	ROAD PROFILE <input checked="" type="checkbox"/> Level <input type="checkbox"/> Downhill <input type="checkbox"/> Dip <input type="checkbox"/> Uphill <input type="checkbox"/> Hillcrest <input type="checkbox"/> Unknown (Explain)	
INTERSECTION TYPE <input checked="" type="checkbox"/> 4-way Intersection <input type="checkbox"/> Y-Intersection <input type="checkbox"/> 5-way / More <input type="checkbox"/> Unknown (Explain) <input type="checkbox"/> T-Intersection <input type="checkbox"/> Roundabout <input type="checkbox"/> Other (Explain)			ROAD CONDITION <input checked="" type="checkbox"/> Dry <input type="checkbox"/> Snow <input type="checkbox"/> Slush <input type="checkbox"/> Standing Water <input type="checkbox"/> Sand / Gravel <input type="checkbox"/> Unknown (Explain) <input type="checkbox"/> Wet <input type="checkbox"/> Ice / Frost <input type="checkbox"/> Mud / Dirt <input type="checkbox"/> Moving Water <input type="checkbox"/> Other (Explain)		
GEO - CODE NA					

The sequence of events (*Section 7C*) for Vehicle #1 is "Start in Traffic" (9), and "Collision Inv. MV in Transport" (34). The sequence of events for Vehicle #2 is "Going Straight" (1) and "Collision Inv. MV in Transport" (34).

Vehicle #1:

7C. VEHICLE ACTION / SEQUENCE OF EVENTS CODES					
SEQUENCE OF EVENTS CODES					<input type="checkbox"/> Unknown
9	34				

Vehicle #2:

7C. VEHICLE ACTION / SEQUENCE OF EVENTS CODES					
SEQUENCE OF EVENTS CODES					<input type="checkbox"/> Unknown
1	34				

In this case, the *Compass Direction* under *Section 6 - Collision Diagram* should reflect vehicle #1 as "S" (south) and vehicle #2 as "W" (west).



### ROUNDBABOUTS / TRAFFIC CIRCLES / CONNECTORS

Crashes occurring within the circle of a roundabout or traffic circle are shown as being "At" the intersection. Crashes occurring on one of the approaching or diverging lanes should be measured to the roundabout circle and then shown "Before" or "After" the intersecting roadway (whichever is appropriate).

#### Example #1:

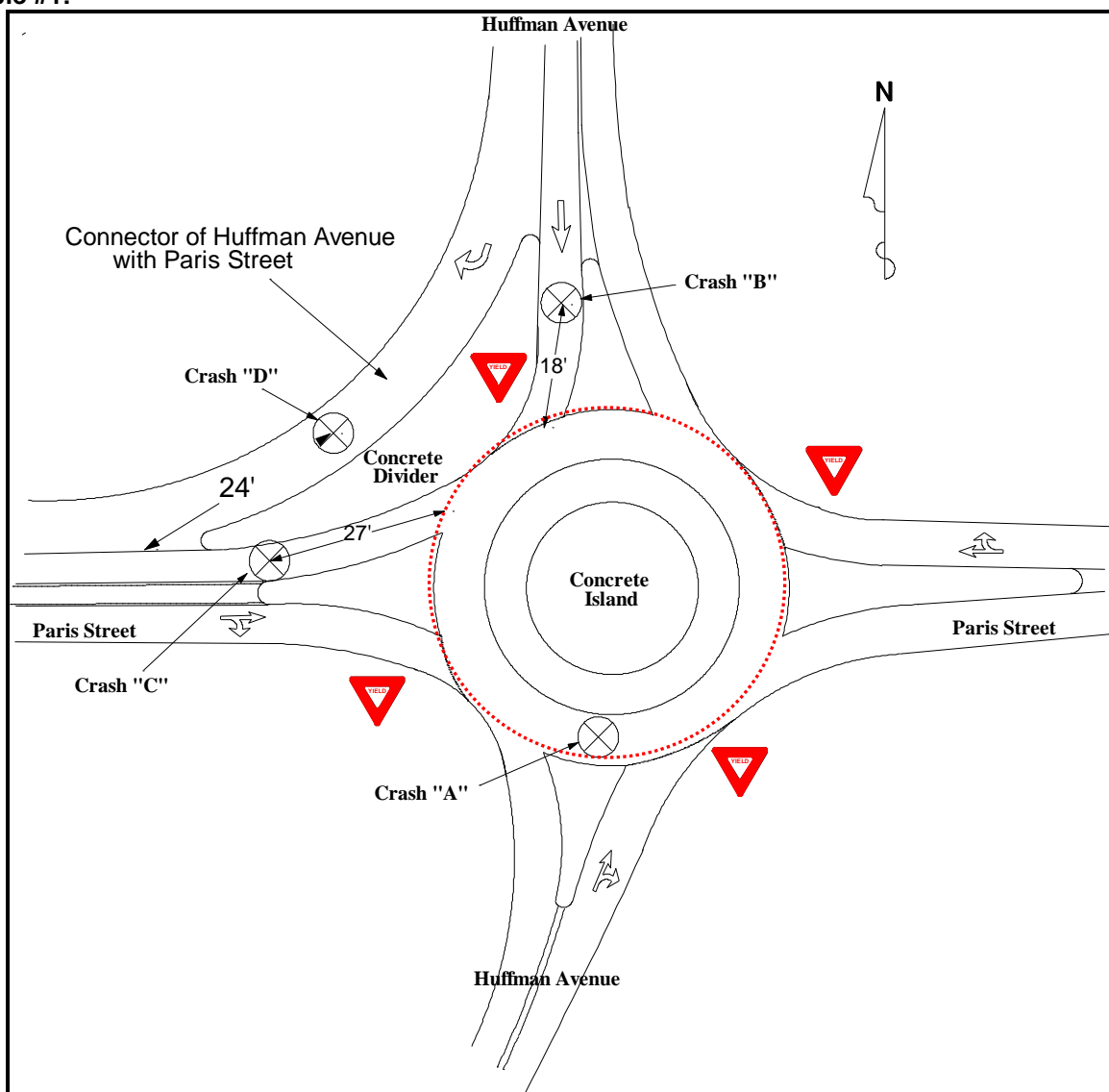

The area within the dashed circle in the above example is considered "At" the intersection of CST Huffman AVE and CST Paris ST.

**Crash "A":**

Crash "A" occurred within the boundaries of the roundabout circle and is located (*Section 2 - Location*) within the intersection. The location can be shown on the crash report as occurring on Paris Street or Huffman Avenue.

1. On CST Paris ST (Roadway Direction - "E"), At CST Huffman AVE. The direction of the intersecting roadway (Int. Dir.) is shown as either "N" or "S" because the crash occurred within the intersection.

ON CST Paris ST		RDWY. DIR. E	DISTANCE FROM _____ Feet _____ Miles	LOCATION <input type="checkbox"/> After <input type="checkbox"/> NA <input type="checkbox"/> Before <input type="checkbox"/> NA <input checked="" type="checkbox"/> At	INTERSECTING CST Huffman AVE
SPEED LIMIT 35	ROAD MAINTAINED BY <input type="checkbox"/> Unknown <input type="checkbox"/> State <input type="checkbox"/> County <input checked="" type="checkbox"/> Municipal <input type="checkbox"/> Private Property <input type="checkbox"/> Other				SPEED LIMIT 35 INT. DIR. N GEO - CODE NA
TRAFFICWAY <input checked="" type="checkbox"/> One-Way <input type="checkbox"/> Two-Way; Not Divided <input type="checkbox"/> Two-Way; Divided; Unprotected Median <input type="checkbox"/> Other <input type="checkbox"/> Two-Way; Not Divided; Continuous Center Turn Lane <input type="checkbox"/> Two-Way; Divided; Positive Median Barrier <input type="checkbox"/> Unknown		ROAD ALIGNMENT <input type="checkbox"/> Straight <input checked="" type="checkbox"/> Curve <input type="checkbox"/> Unknown (Explain)		ROAD PROFILE <input checked="" type="checkbox"/> Level <input type="checkbox"/> Downhill <input type="checkbox"/> Dip <input type="checkbox"/> Uphill <input type="checkbox"/> Hillcrest <input type="checkbox"/> Unknown (Explain)	
INTERSECTION TYPE <input type="checkbox"/> 4-way Intersection <input type="checkbox"/> Y-Intersection <input type="checkbox"/> 5-way / More <input type="checkbox"/> Unknown (Explain) <input type="checkbox"/> T-Intersection <input checked="" type="checkbox"/> Roundabout <input type="checkbox"/> Other (Explain)		ROAD CONDITION <input checked="" type="checkbox"/> Dry <input type="checkbox"/> Snow <input type="checkbox"/> Slush <input type="checkbox"/> Standing Water <input type="checkbox"/> Sand / Gravel <input type="checkbox"/> Unknown (Explain) <input type="checkbox"/> Wet <input type="checkbox"/> Ice / Frost <input type="checkbox"/> Mud / Dirt <input type="checkbox"/> Moving Water <input type="checkbox"/> Other (Explain)			

2. On CST Huffman AVE (Roadway Direction - "N" or "S"), At CST Paris ST. The direction of the intersecting roadway (Int. Dir.) is shown as either "E" or "W" because the crash occurred within the intersection.

ON CST Huffman AVE		RDWY. DIR. N	DISTANCE FROM _____ Feet _____ Miles	LOCATION <input type="checkbox"/> After <input type="checkbox"/> NA <input type="checkbox"/> Before <input type="checkbox"/> NA <input checked="" type="checkbox"/> At	INTERSECTING CST Paris ST
SPEED LIMIT 35	ROAD MAINTAINED BY <input type="checkbox"/> Unknown <input type="checkbox"/> State <input type="checkbox"/> County <input checked="" type="checkbox"/> Municipal <input type="checkbox"/> Private Property <input type="checkbox"/> Other				SPEED LIMIT 35 INT. DIR. E GEO - CODE NA
TRAFFICWAY <input checked="" type="checkbox"/> One-Way <input type="checkbox"/> Two-Way; Not Divided <input type="checkbox"/> Two-Way; Divided; Unprotected Median <input type="checkbox"/> Other <input type="checkbox"/> Two-Way; Not Divided; Continuous Center Turn Lane <input type="checkbox"/> Two-Way; Divided; Positive Median Barrier <input type="checkbox"/> Unknown		ROAD ALIGNMENT <input type="checkbox"/> Straight <input checked="" type="checkbox"/> Curve <input type="checkbox"/> Unknown (Explain)		ROAD PROFILE <input checked="" type="checkbox"/> Level <input type="checkbox"/> Downhill <input type="checkbox"/> Dip <input type="checkbox"/> Uphill <input type="checkbox"/> Hillcrest <input type="checkbox"/> Unknown (Explain)	
INTERSECTION TYPE <input type="checkbox"/> 4-way Intersection <input type="checkbox"/> Y-Intersection <input type="checkbox"/> 5-way / More <input type="checkbox"/> Unknown (Explain) <input type="checkbox"/> T-Intersection <input checked="" type="checkbox"/> Roundabout <input type="checkbox"/> Other (Explain)		ROAD CONDITION <input checked="" type="checkbox"/> Dry <input type="checkbox"/> Snow <input type="checkbox"/> Slush <input type="checkbox"/> Standing Water <input type="checkbox"/> Sand / Gravel <input type="checkbox"/> Unknown (Explain) <input type="checkbox"/> Wet <input type="checkbox"/> Ice / Frost <input type="checkbox"/> Mud / Dirt <input type="checkbox"/> Moving Water <input type="checkbox"/> Other (Explain)			

**Crash "B":**

Crash "B" is measured to the roundabout circle and is located (*Section 2 - Location*) On CST Huffman AVE (Roadway Direction - "S"), 18 feet Before CST Paris ST. The direction of the intersecting roadway (Int. Dir.) is "W" because the location was measured to the westbound lane of CST Paris ST.

ON CST Huffman AVE		RDWY. DIR. S	DISTANCE FROM 18 _____ Feet _____ Miles	LOCATION <input type="checkbox"/> After <input type="checkbox"/> NA <input checked="" type="checkbox"/> Before <input type="checkbox"/> NA <input type="checkbox"/> At	INTERSECTING CST Paris ST
SPEED LIMIT 35	ROAD MAINTAINED BY <input type="checkbox"/> Unknown <input type="checkbox"/> State <input type="checkbox"/> County <input checked="" type="checkbox"/> Municipal <input type="checkbox"/> Private Property <input type="checkbox"/> Other				SPEED LIMIT NA INT. DIR. W GEO - CODE NA
TRAFFICWAY <input checked="" type="checkbox"/> One-Way <input type="checkbox"/> Two-Way; Not Divided <input type="checkbox"/> Two-Way; Divided; Unprotected Median <input type="checkbox"/> Other <input type="checkbox"/> Two-Way; Not Divided; Continuous Center Turn Lane <input type="checkbox"/> Two-Way; Divided; Positive Median Barrier <input type="checkbox"/> Unknown		ROAD ALIGNMENT <input checked="" type="checkbox"/> Straight <input type="checkbox"/> Curve <input type="checkbox"/> Unknown (Explain)		ROAD PROFILE <input checked="" type="checkbox"/> Level <input type="checkbox"/> Downhill <input type="checkbox"/> Dip <input type="checkbox"/> Uphill <input type="checkbox"/> Hillcrest <input type="checkbox"/> Unknown (Explain)	
INTERSECTION TYPE <input type="checkbox"/> 4-way Intersection <input type="checkbox"/> Y-Intersection <input type="checkbox"/> 5-way / More <input type="checkbox"/> Unknown (Explain) <input type="checkbox"/> T-Intersection <input type="checkbox"/> Roundabout <input type="checkbox"/> Other (Explain)		ROAD CONDITION <input checked="" type="checkbox"/> Dry <input type="checkbox"/> Snow <input type="checkbox"/> Slush <input type="checkbox"/> Standing Water <input type="checkbox"/> Sand / Gravel <input type="checkbox"/> Unknown (Explain) <input type="checkbox"/> Wet <input type="checkbox"/> Ice / Frost <input type="checkbox"/> Mud / Dirt <input type="checkbox"/> Moving Water <input type="checkbox"/> Other (Explain)			

**Crash "C":**

Crash "C" is measured to the roundabout circle and is located (*Section 2 - Location*) On CST Paris ST (Roadway Direction - "W"), 27 feet After CST Huffman AVE. The direction of the intersecting roadway (Int. Dir.) is "S" because the location was measured to the southbound lane of CST Huffman AVE.

ON CST Paris ST		RDWY. DIR. W	DISTANCE FROM 27 _____ Feet _____ Miles	LOCATION <input checked="" type="checkbox"/> After <input type="checkbox"/> NA <input type="checkbox"/> Before <input type="checkbox"/> NA <input type="checkbox"/> At	INTERSECTING CST Huffman AVE
SPEED LIMIT 35	ROAD MAINTAINED BY <input type="checkbox"/> Unknown <input type="checkbox"/> State <input type="checkbox"/> County <input checked="" type="checkbox"/> Municipal <input type="checkbox"/> Private Property <input type="checkbox"/> Other				SPEED LIMIT NA INT. DIR. S GEO - CODE NA
TRAFFICWAY <input checked="" type="checkbox"/> One-Way <input type="checkbox"/> Two-Way; Not Divided <input type="checkbox"/> Two-Way; Divided; Unprotected Median <input type="checkbox"/> Other <input type="checkbox"/> Two-Way; Not Divided; Continuous Center Turn Lane <input type="checkbox"/> Two-Way; Divided; Positive Median Barrier <input type="checkbox"/> Unknown		ROAD ALIGNMENT <input type="checkbox"/> Straight <input checked="" type="checkbox"/> Curve <input type="checkbox"/> Unknown (Explain)		ROAD PROFILE <input checked="" type="checkbox"/> Level <input type="checkbox"/> Downhill <input type="checkbox"/> Dip <input type="checkbox"/> Uphill <input type="checkbox"/> Hillcrest <input type="checkbox"/> Unknown (Explain)	
INTERSECTION TYPE <input type="checkbox"/> 4-way Intersection <input type="checkbox"/> Y-Intersection <input type="checkbox"/> 5-way / More <input type="checkbox"/> Unknown (Explain) <input type="checkbox"/> T-Intersection <input type="checkbox"/> Roundabout <input type="checkbox"/> Other (Explain)		ROAD CONDITION <input checked="" type="checkbox"/> Dry <input type="checkbox"/> Snow <input type="checkbox"/> Slush <input type="checkbox"/> Standing Water <input type="checkbox"/> Sand / Gravel <input type="checkbox"/> Unknown (Explain) <input type="checkbox"/> Wet <input type="checkbox"/> Ice / Frost <input type="checkbox"/> Mud / Dirt <input type="checkbox"/> Moving Water <input type="checkbox"/> Other (Explain)			

**Crash "D":**

Crash "D" is in a right turn only lane, which is a connector between Huffman Avenue and Paris Street. The crash is located by measuring to the intersection of the connector with Paris Street. The location is shown on the crash report as occurring on CO (Connector) Huffman AVE to Paris ST (Roadway Direction - "S"), 24 feet Before CST Paris ST (Int. Dir. - "W").

ON CO Huffman AVE to Paris ST		RDWY. DIR. S	DISTANCE FROM 24 <input type="checkbox"/> NA Feet	LOCATION <input checked="" type="checkbox"/> Before <input type="checkbox"/> NA <input type="checkbox"/> At	INTERSECTING CST Paris ST		
SPEED LIMIT 35	ROAD MAINTAINED BY <input type="checkbox"/> State <input type="checkbox"/> County <input checked="" type="checkbox"/> Municipal <input type="checkbox"/> Private Property <input type="checkbox"/> Other				SPEED LIMIT NA	INT. DIR. W	GEO - CODE NA
TRAFFICWAY <input checked="" type="checkbox"/> One-Way <input type="checkbox"/> Two-Way; Not Divided <input type="checkbox"/> Two-Way; Divided; Unprotected Median <input type="checkbox"/> Other <input type="checkbox"/> Two-Way; Not Divided; Continuous Center Turn Lane <input type="checkbox"/> Two-Way; Divided; Positive Median Barrier <input type="checkbox"/> Unknown				ROAD ALIGNMENT <input type="checkbox"/> Straight <input checked="" type="checkbox"/> Curve <input type="checkbox"/> Unknown (Explain)		ROAD PROFILE <input checked="" type="checkbox"/> Level <input type="checkbox"/> Downhill <input type="checkbox"/> Dip <input type="checkbox"/> Uphill <input type="checkbox"/> Hillcrest <input type="checkbox"/> Unknown (Explain)	
INTERSECTION TYPE <input checked="" type="checkbox"/> NA <input type="checkbox"/> 4-way Intersection <input type="checkbox"/> Y-Intersection <input type="checkbox"/> 5-way / More <input type="checkbox"/> Unknown (Explain) <input type="checkbox"/> T-Intersection <input type="checkbox"/> Roundabout <input type="checkbox"/> Other (Explain)			ROAD CONDITION <input checked="" type="checkbox"/> Dry <input type="checkbox"/> Snow <input type="checkbox"/> Slush <input type="checkbox"/> Standing Water <input type="checkbox"/> Sand / Gravel <input type="checkbox"/> Unknown (Explain) <input type="checkbox"/> Wet <input type="checkbox"/> Ice / Frost <input type="checkbox"/> Mud / Dirt <input type="checkbox"/> Moving Water <input type="checkbox"/> Other (Explain)				

## INTERCHANGES

Traffic crashes occurring within interchanges are located on the roadways on which they occur, i.e., ramps, overpasses, primary roadway, etc. and to the nearest roadway, gore, ERM, or bridge structure.

Ramp numbers must be used when a crash occurs on a ramp. The numbers can be found in the [MoDOT Interactive Mapping Tool](#). For example, a crash occurring on ramp number 6998, located on IS 70 eastbound at US 54, will be shown in this field as "RP 6998." The crashes should then be measured to the nearest roadway, painted gore (where the ramp leaves or joins a roadway - see diagrams below), or bridge structure. Ramps can overlap other ramps. The method for locating crashes on overlapping ramps is explained in [Examples #7 \(Diverging Diamond Interchanges\)](#) and [#8 \(Directional Interchanges\)](#) below.

### Diamond Interchanges

#### Example #1:

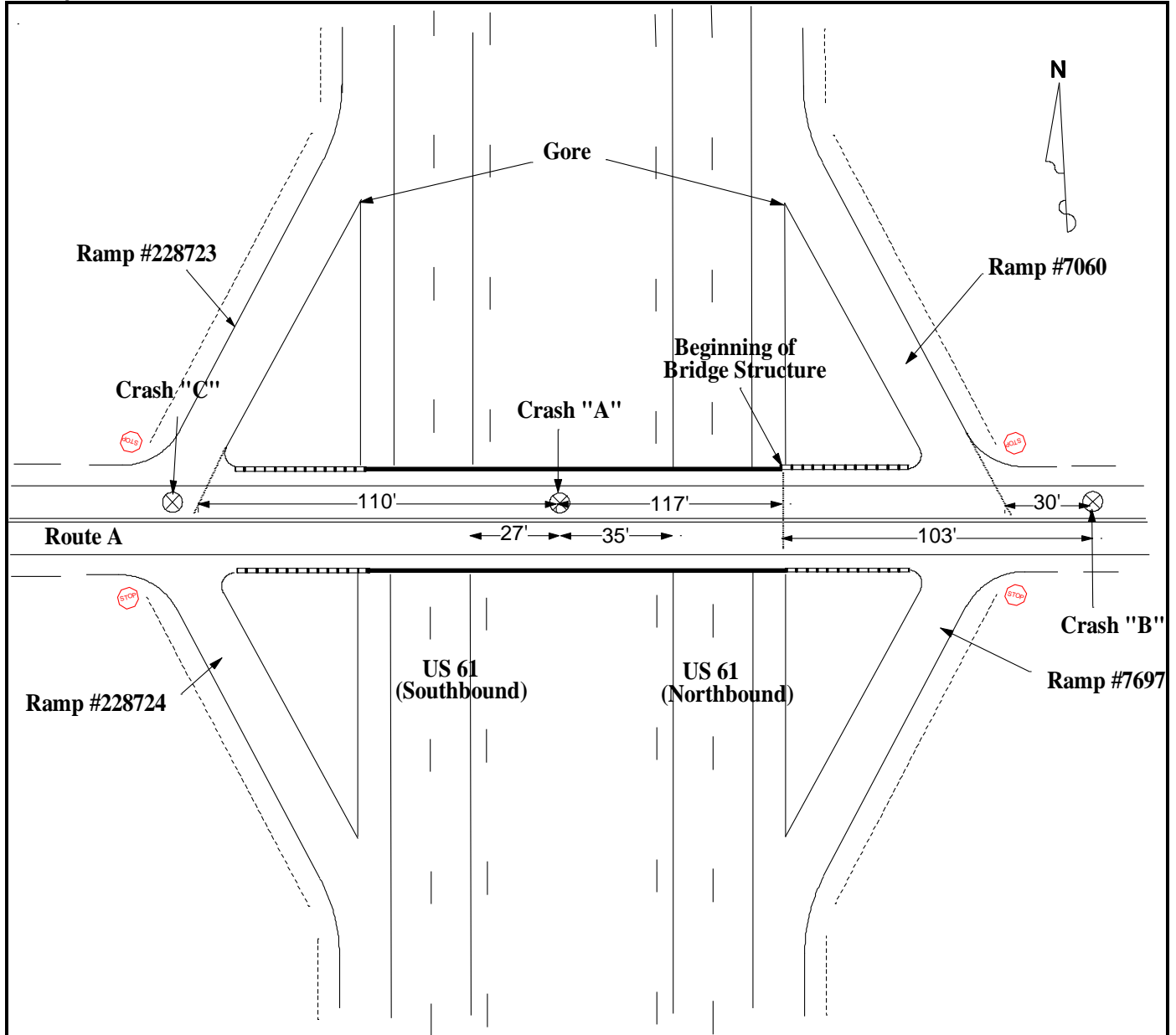

The fact that the crashes occurred within the interchange is immaterial as far as completion of the crash report is concerned. Crash "A" and Crash "B" can be located to the nearest roadways (including ramps) or to the beginning of the bridge structure and Crash "C" is located within the intersection of Ramp 228723 and Route A.

**Crash "A":**

Crash "A" can be measured to the beginning of the bridge structure in the eastbound lane (as shown in diagram), Ramp 228723 (as shown in diagram and below), Ramp 7060 (not shown), southbound lanes of US 61 (as shown in diagram), or northbound lanes of US 61 (as shown in diagram).

ON RT A		RDWY. DIR. W	DISTANCE FROM 110 Feet Miles	LOCATION <input type="checkbox"/> After <input type="checkbox"/> NA <input checked="" type="checkbox"/> Before <input type="checkbox"/> At	INTERSECTING RP 228723
SPEED LIMIT 45	ROAD MAINTAINED BY <input checked="" type="checkbox"/> State <input type="checkbox"/> County <input type="checkbox"/> Municipal <input type="checkbox"/> Private Property <input type="checkbox"/> Other			<input type="checkbox"/> NA	SPEED LIMIT NA
TRAFFICWAY <input type="checkbox"/> One-Way <input checked="" type="checkbox"/> Two-Way; Not Divided <input type="checkbox"/> Two-Way; Divided; Unprotected Median <input type="checkbox"/> Other <input type="checkbox"/> Two-Way; Not Divided; Continuous Center Turn Lane <input type="checkbox"/> Two-Way; Divided; Positive Median Barrier <input type="checkbox"/> Unknown			ROAD ALIGNMENT <input checked="" type="checkbox"/> Straight <input type="checkbox"/> Curve <input type="checkbox"/> Unknown (Explain)	ROAD PROFILE <input checked="" type="checkbox"/> Level <input type="checkbox"/> Downhill <input type="checkbox"/> Dip <input type="checkbox"/> Uphill <input type="checkbox"/> Hillcrest <input type="checkbox"/> Unknown (Explain)	
INTERSECTION TYPE <input type="checkbox"/> 4-way Intersection <input type="checkbox"/> Y-Intersection <input type="checkbox"/> 5-way / More <input type="checkbox"/> Unknown (Explain) <input type="checkbox"/> T-Intersection <input type="checkbox"/> Roundabout <input type="checkbox"/> Other (Explain)			ROAD CONDITION <input checked="" type="checkbox"/> Dry <input type="checkbox"/> Snow <input type="checkbox"/> Slush <input type="checkbox"/> Standing Water <input type="checkbox"/> Sand / Gravel <input type="checkbox"/> Unknown (Explain) <input type="checkbox"/> Wet <input type="checkbox"/> Ice / Frost <input type="checkbox"/> Mud / Dirt <input type="checkbox"/> Moving Water <input type="checkbox"/> Other (Explain)		

**Crash "B":**

Crash "B" can be measured to Ramp 7060 (as shown in diagram and below) or to the beginning of the bridge structure in the eastbound lane (as shown in diagram). It could also be measured to any of the other roadways (including ramps).

ON RT A		RDWY. DIR. W	DISTANCE FROM 30 Feet Miles	LOCATION <input type="checkbox"/> After <input type="checkbox"/> NA <input checked="" type="checkbox"/> Before <input type="checkbox"/> At	INTERSECTING RP 7060
SPEED LIMIT 45	ROAD MAINTAINED BY <input checked="" type="checkbox"/> State <input type="checkbox"/> County <input type="checkbox"/> Municipal <input type="checkbox"/> Private Property <input type="checkbox"/> Other			<input type="checkbox"/> NA	SPEED LIMIT NA
TRAFFICWAY <input type="checkbox"/> One-Way <input checked="" type="checkbox"/> Two-Way; Not Divided <input type="checkbox"/> Two-Way; Divided; Unprotected Median <input type="checkbox"/> Other <input type="checkbox"/> Two-Way; Not Divided; Continuous Center Turn Lane <input type="checkbox"/> Two-Way; Divided; Positive Median Barrier <input type="checkbox"/> Unknown			ROAD ALIGNMENT <input checked="" type="checkbox"/> Straight <input type="checkbox"/> Curve <input type="checkbox"/> Unknown (Explain)	ROAD PROFILE <input checked="" type="checkbox"/> Level <input type="checkbox"/> Downhill <input type="checkbox"/> Dip <input type="checkbox"/> Uphill <input type="checkbox"/> Hillcrest <input type="checkbox"/> Unknown (Explain)	
INTERSECTION TYPE <input type="checkbox"/> 4-way Intersection <input type="checkbox"/> Y-Intersection <input type="checkbox"/> 5-way / More <input type="checkbox"/> Unknown (Explain) <input type="checkbox"/> T-Intersection <input type="checkbox"/> Roundabout <input type="checkbox"/> Other (Explain)			ROAD CONDITION <input checked="" type="checkbox"/> Dry <input type="checkbox"/> Snow <input type="checkbox"/> Slush <input type="checkbox"/> Standing Water <input type="checkbox"/> Sand / Gravel <input type="checkbox"/> Unknown (Explain) <input type="checkbox"/> Wet <input type="checkbox"/> Ice / Frost <input type="checkbox"/> Mud / Dirt <input type="checkbox"/> Moving Water <input type="checkbox"/> Other (Explain)		

**Crash "C":**

Crash "C" occurred within the intersection of Ramp 228723 and Route A. It is located either on RT A At RP 228723 (shown below) or on RP 228723 At RT A.

ON RT A		RDWY. DIR. W	DISTANCE FROM <input checked="" type="checkbox"/> NA Feet Miles	LOCATION <input type="checkbox"/> After <input type="checkbox"/> NA <input type="checkbox"/> Before <input checked="" type="checkbox"/> At	INTERSECTING RP 228723
SPEED LIMIT 45	ROAD MAINTAINED BY <input checked="" type="checkbox"/> State <input type="checkbox"/> County <input type="checkbox"/> Municipal <input type="checkbox"/> Private Property <input type="checkbox"/> Other			<input type="checkbox"/> NA	SPEED LIMIT 65
TRAFFICWAY <input type="checkbox"/> One-Way <input checked="" type="checkbox"/> Two-Way; Not Divided <input type="checkbox"/> Two-Way; Divided; Unprotected Median <input type="checkbox"/> Other <input type="checkbox"/> Two-Way; Not Divided; Continuous Center Turn Lane <input type="checkbox"/> Two-Way; Divided; Positive Median Barrier <input type="checkbox"/> Unknown			ROAD ALIGNMENT <input checked="" type="checkbox"/> Straight <input type="checkbox"/> Curve <input type="checkbox"/> Unknown (Explain)	ROAD PROFILE <input checked="" type="checkbox"/> Level <input type="checkbox"/> Downhill <input type="checkbox"/> Dip <input type="checkbox"/> Uphill <input type="checkbox"/> Hillcrest <input type="checkbox"/> Unknown (Explain)	
INTERSECTION TYPE <input checked="" type="checkbox"/> 4-way Intersection <input type="checkbox"/> Y-Intersection <input type="checkbox"/> 5-way / More <input type="checkbox"/> Unknown (Explain) <input type="checkbox"/> T-Intersection <input type="checkbox"/> Roundabout <input type="checkbox"/> Other (Explain)			ROAD CONDITION <input checked="" type="checkbox"/> Dry <input type="checkbox"/> Snow <input type="checkbox"/> Slush <input type="checkbox"/> Standing Water <input type="checkbox"/> Sand / Gravel <input type="checkbox"/> Unknown (Explain) <input type="checkbox"/> Wet <input type="checkbox"/> Ice / Frost <input type="checkbox"/> Mud / Dirt <input type="checkbox"/> Moving Water <input type="checkbox"/> Other (Explain)		

**Example #2:**

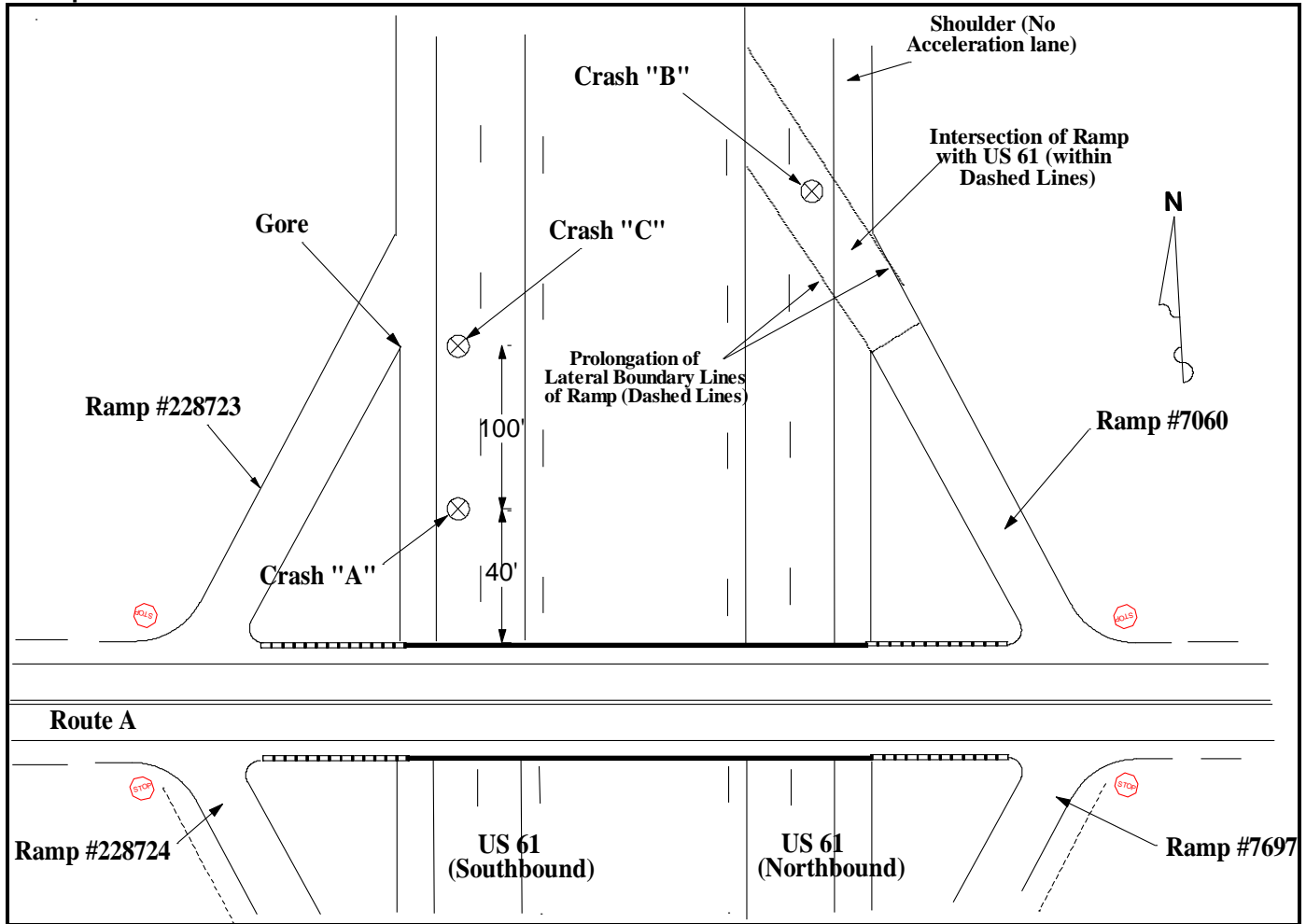

The fact that the crashes occurred within the interchange is immaterial as far as completion of the crash report is concerned. Crashes "A" and "C" can be located to the nearest roadway (westbound lane of Route A), to the painted gore on the corresponding ramp, or to the closest ERM (if on an Interstate). Crash "C" can also be located "At" the painted gore on the ramp. Crash "B" is located within the intersection of US 61 and the ramp (since there is no acceleration lane).

**Crash "A":**

Crash "A" can be measured to Route A (shown below) or the gore with Ramp #228723.

ON US 61		RDWY. DIR. S	DISTANCE FROM 40 <input type="checkbox"/> NA Feet Miles	LOCATION <input type="checkbox"/> After <input type="checkbox"/> NA <input checked="" type="checkbox"/> Before <input type="checkbox"/> At	INTERSECTING RT A
SPEED LIMIT 65	ROAD MAINTAINED BY <input checked="" type="checkbox"/> State <input type="checkbox"/> County <input type="checkbox"/> Municipal <input type="checkbox"/> Private Property <input type="checkbox"/> Other				SPEED LIMIT NA
TRAFFICWAY <input type="checkbox"/> One-Way <input type="checkbox"/> Two-Way; Not Divided <input checked="" type="checkbox"/> Two-Way; Divided; Unprotected Median <input type="checkbox"/> Other <input type="checkbox"/> Two-Way; Not Divided; Continuous Center Turn Lane <input type="checkbox"/> Two-Way; Divided; Positive Median Barrier <input type="checkbox"/> Unknown			ROAD ALIGNMENT <input checked="" type="checkbox"/> Straight <input type="checkbox"/> Curve <input type="checkbox"/> Unknown (Explain)		ROAD PROFILE <input checked="" type="checkbox"/> Level <input type="checkbox"/> Downhill <input type="checkbox"/> Dip <input type="checkbox"/> Uphill <input type="checkbox"/> Hillcrest <input type="checkbox"/> Unknown (Explain)
INTERSECTION TYPE <input type="checkbox"/> 4-way Intersection <input type="checkbox"/> Y-Intersection <input type="checkbox"/> 5-way / More <input type="checkbox"/> Unknown (Explain) <input type="checkbox"/> T-Intersection <input type="checkbox"/> Roundabout <input type="checkbox"/> Other (Explain)			ROAD CONDITION <input checked="" type="checkbox"/> Dry <input type="checkbox"/> Snow <input type="checkbox"/> Slush <input type="checkbox"/> Standing Water <input type="checkbox"/> Sand / Gravel <input type="checkbox"/> Unknown (Explain) <input type="checkbox"/> Wet <input type="checkbox"/> Ice / Frost <input type="checkbox"/> Mud / Dirt <input type="checkbox"/> Moving Water <input type="checkbox"/> Other (Explain)		

**Crash "B":**

Crash "B" is within the intersection of the Northbound lanes of US 61 and Ramp #7060. It can be shown as occurring either On US 61 (Roadway Direction - "N") At RP 7060 (shown below) or On RP 7060 (Roadway Direction - "N") At US 61 (shown below). **This only applied because there is no acceleration (or deceleration) lane in the example. The crash would be measured to the nearest gore, roadway, or ERM if an acceleration lane had been present.**

ON US 61		RDWY. DIR. N	DISTANCE FROM NA Feet Miles	LOCATION <input type="checkbox"/> After <input type="checkbox"/> NA <input type="checkbox"/> Before <input checked="" type="checkbox"/> At	INTERSECTING RP 7060
SPEED LIMIT 65	ROAD MAINTAINED BY <input checked="" type="checkbox"/> State <input type="checkbox"/> County <input type="checkbox"/> Municipal <input type="checkbox"/> Private Property <input type="checkbox"/> Other				SPEED LIMIT 45
TRAFFICWAY <input type="checkbox"/> One-Way <input type="checkbox"/> Two-Way; Not Divided <input checked="" type="checkbox"/> Two-Way; Divided; Unprotected Median <input type="checkbox"/> Other <input type="checkbox"/> Two-Way; Not Divided; Continuous Center Turn Lane <input type="checkbox"/> Two-Way; Divided; Positive Median Barrier <input type="checkbox"/> Unknown		ROAD ALIGNMENT <input checked="" type="checkbox"/> Straight <input type="checkbox"/> Curve <input type="checkbox"/> Unknown (Explain)		ROAD PROFILE <input checked="" type="checkbox"/> Level <input type="checkbox"/> Downhill <input type="checkbox"/> Dip <input type="checkbox"/> Uphill <input type="checkbox"/> Hillcrest <input type="checkbox"/> Unknown (Explain)	
INTERSECTION TYPE <input type="checkbox"/> NA <input type="checkbox"/> 4-way Intersection <input checked="" type="checkbox"/> Y-Intersection <input type="checkbox"/> 5-way / More <input type="checkbox"/> Unknown (Explain) <input type="checkbox"/> T-Intersection <input type="checkbox"/> Roundabout <input type="checkbox"/> Other (Explain)		ROAD CONDITION <input checked="" type="checkbox"/> Dry <input type="checkbox"/> Snow <input type="checkbox"/> Slush <input type="checkbox"/> Standing Water <input type="checkbox"/> Sand / Gravel <input type="checkbox"/> Unknown (Explain) <input type="checkbox"/> Wet <input type="checkbox"/> Ice / Frost <input type="checkbox"/> Mud / Dirt <input type="checkbox"/> Moving Water <input type="checkbox"/> Other (Explain)			

ON RP 7060		RDWY. DIR. N	DISTANCE FROM NA Feet Miles	LOCATION <input type="checkbox"/> After <input type="checkbox"/> NA <input type="checkbox"/> Before <input checked="" type="checkbox"/> At	INTERSECTING US 61
SPEED LIMIT 45	ROAD MAINTAINED BY <input checked="" type="checkbox"/> State <input type="checkbox"/> County <input type="checkbox"/> Municipal <input type="checkbox"/> Private Property <input type="checkbox"/> Other				SPEED LIMIT 65
TRAFFICWAY <input checked="" type="checkbox"/> One-Way <input type="checkbox"/> Two-Way; Not Divided <input type="checkbox"/> Two-Way; Divided; Unprotected Median <input type="checkbox"/> Other <input type="checkbox"/> Two-Way; Not Divided; Continuous Center Turn Lane <input type="checkbox"/> Two-Way; Divided; Positive Median Barrier <input type="checkbox"/> Unknown		ROAD ALIGNMENT <input checked="" type="checkbox"/> Straight <input type="checkbox"/> Curve <input type="checkbox"/> Unknown (Explain)		ROAD PROFILE <input checked="" type="checkbox"/> Level <input type="checkbox"/> Downhill <input type="checkbox"/> Dip <input type="checkbox"/> Uphill <input type="checkbox"/> Hillcrest <input type="checkbox"/> Unknown (Explain)	
INTERSECTION TYPE <input type="checkbox"/> NA <input type="checkbox"/> 4-way Intersection <input checked="" type="checkbox"/> Y-Intersection <input type="checkbox"/> 5-way / More <input type="checkbox"/> Unknown (Explain) <input type="checkbox"/> T-Intersection <input type="checkbox"/> Roundabout <input type="checkbox"/> Other (Explain)		ROAD CONDITION <input checked="" type="checkbox"/> Dry <input type="checkbox"/> Snow <input type="checkbox"/> Slush <input type="checkbox"/> Standing Water <input type="checkbox"/> Sand / Gravel <input type="checkbox"/> Unknown (Explain) <input type="checkbox"/> Wet <input type="checkbox"/> Ice / Frost <input type="checkbox"/> Mud / Dirt <input type="checkbox"/> Moving Water <input type="checkbox"/> Other (Explain)			

**Crash "C":**

Crash "C" occurred on US 61 At the painted gore with Ramp 228723. It can be located At the gore (shown below) or measured to Route A.

Note: "Intersection Type" is shown as "NA" because this location does not meet the definition of an intersection.

ON US 61		RDWY. DIR. S	DISTANCE FROM NA Feet Miles	LOCATION <input type="checkbox"/> After <input type="checkbox"/> NA <input type="checkbox"/> Before <input checked="" type="checkbox"/> At	INTERSECTING RP 228723
SPEED LIMIT 65	ROAD MAINTAINED BY <input checked="" type="checkbox"/> State <input type="checkbox"/> County <input type="checkbox"/> Municipal <input type="checkbox"/> Private Property <input type="checkbox"/> Other				SPEED LIMIT 65
TRAFFICWAY <input type="checkbox"/> One-Way <input type="checkbox"/> Two-Way; Not Divided <input checked="" type="checkbox"/> Two-Way; Divided; Unprotected Median <input type="checkbox"/> Other <input type="checkbox"/> Two-Way; Not Divided; Continuous Center Turn Lane <input type="checkbox"/> Two-Way; Divided; Positive Median Barrier <input type="checkbox"/> Unknown		ROAD ALIGNMENT <input checked="" type="checkbox"/> Straight <input type="checkbox"/> Curve <input type="checkbox"/> Unknown (Explain)		ROAD PROFILE <input checked="" type="checkbox"/> Level <input type="checkbox"/> Downhill <input type="checkbox"/> Dip <input type="checkbox"/> Uphill <input type="checkbox"/> Hillcrest <input type="checkbox"/> Unknown (Explain)	
INTERSECTION TYPE <input checked="" type="checkbox"/> NA <input type="checkbox"/> 4-way Intersection <input type="checkbox"/> Y-Intersection <input type="checkbox"/> 5-way / More <input type="checkbox"/> Unknown (Explain) <input type="checkbox"/> T-Intersection <input type="checkbox"/> Roundabout <input type="checkbox"/> Other (Explain)		ROAD CONDITION <input checked="" type="checkbox"/> Dry <input type="checkbox"/> Snow <input type="checkbox"/> Slush <input type="checkbox"/> Standing Water <input type="checkbox"/> Sand / Gravel <input type="checkbox"/> Unknown (Explain) <input type="checkbox"/> Wet <input type="checkbox"/> Ice / Frost <input type="checkbox"/> Mud / Dirt <input type="checkbox"/> Moving Water <input type="checkbox"/> Other (Explain)			

**Example #3:**

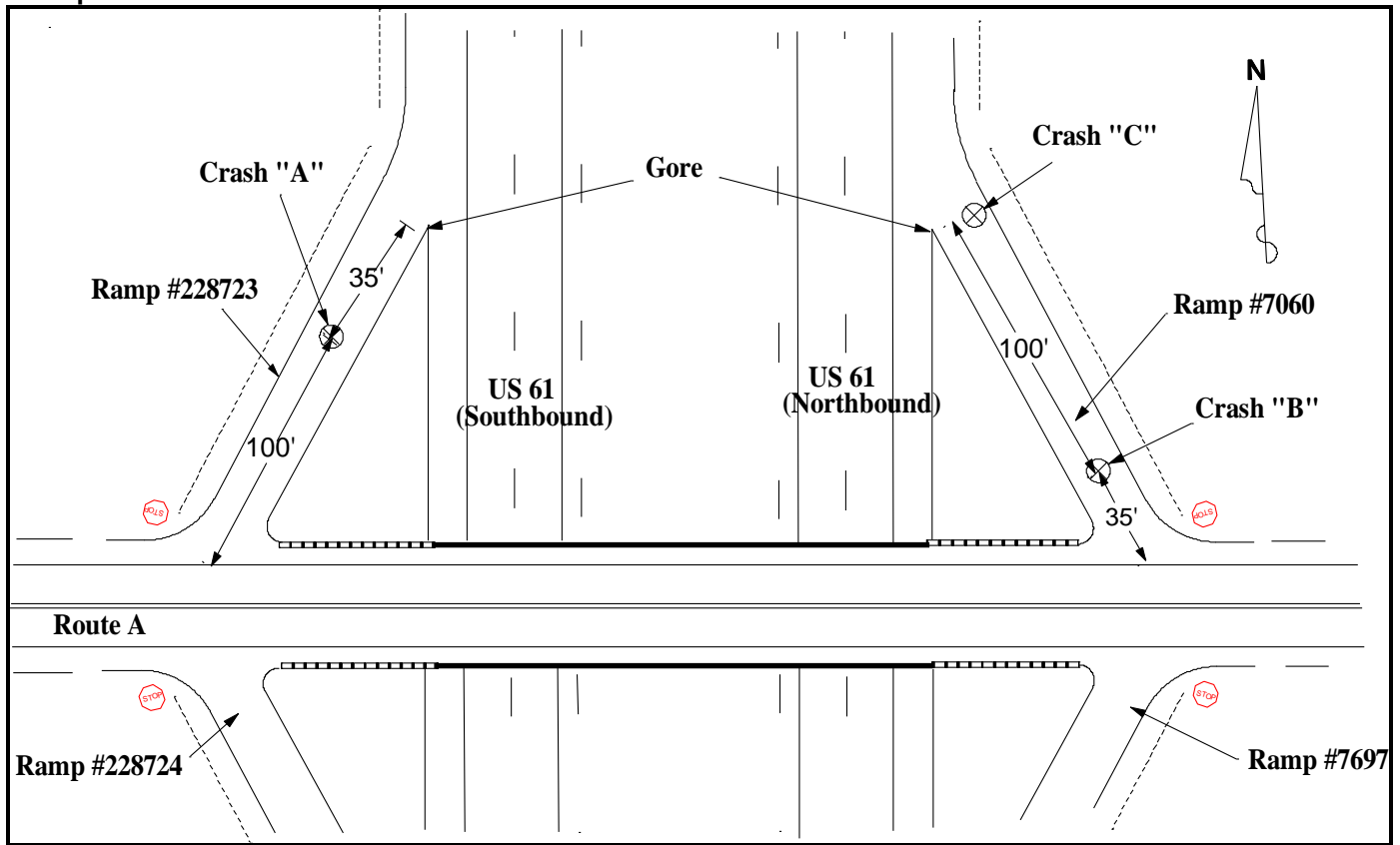

The fact that the crashes occurred within the interchange is immaterial as far as completion of the crash report is concerned. Crashes "A" and "B" can be located to the nearest roadway (westbound lane of Route A) or to the painted gore on the corresponding ramp. Crash "C" is located "At" the painted gore on the ramp.

**Crash "A":**

Crash "A" can be measured to the gore with US 61 or to Route A (shown below).

ON RP 228723		RDWY. DIR. W	DISTANCE FROM 100 Feet	LOCATION <input type="checkbox"/> After <input checked="" type="checkbox"/> Before <input type="checkbox"/> At	INTERSECTING RT A
SPEED LIMIT 65	ROAD MAINTAINED BY <input checked="" type="checkbox"/> State <input type="checkbox"/> County <input type="checkbox"/> Municipal <input type="checkbox"/> Private Property <input type="checkbox"/> Other				SPEED LIMIT NA INT. DIR. W GEO - CODE NA
TRAFFICWAY <input checked="" type="checkbox"/> One-Way <input type="checkbox"/> Two-Way; Not Divided <input type="checkbox"/> Two-Way; Divided; Unprotected Median <input type="checkbox"/> Other <input type="checkbox"/> Two-Way; Not Divided; Continuous Center Turn Lane <input type="checkbox"/> Two-Way; Divided; Positive Median Barrier <input type="checkbox"/> Unknown			ROAD ALIGNMENT <input checked="" type="checkbox"/> Straight <input type="checkbox"/> Curve <input type="checkbox"/> Unknown (Explain)		ROAD PROFILE <input type="checkbox"/> Level <input type="checkbox"/> Downhill <input type="checkbox"/> Dip <input checked="" type="checkbox"/> Uphill <input type="checkbox"/> Hillcrest <input type="checkbox"/> Unknown (Explain)
INTERSECTION TYPE <input checked="" type="checkbox"/> NA <input type="checkbox"/> 4-way Intersection <input type="checkbox"/> Y-Intersection <input type="checkbox"/> 5-way / More <input type="checkbox"/> Unknown (Explain) <input type="checkbox"/> T-Intersection <input type="checkbox"/> Roundabout <input type="checkbox"/> Other (Explain)			ROAD CONDITION <input checked="" type="checkbox"/> Dry <input type="checkbox"/> Snow <input type="checkbox"/> Slush <input type="checkbox"/> Standing Water <input type="checkbox"/> Sand / Gravel <input type="checkbox"/> Unknown (Explain) <input type="checkbox"/> Wet <input type="checkbox"/> Ice / Frost <input type="checkbox"/> Mud / Dirt <input type="checkbox"/> Moving Water <input type="checkbox"/> Other (Explain)		

**Crash "B":**

Crash "B" can be measured to the gore with US 61 (shown below) or to Route A.

ON RP 7060		RDWY. DIR. N	DISTANCE FROM 100 Feet	LOCATION <input type="checkbox"/> After <input checked="" type="checkbox"/> Before <input type="checkbox"/> At	INTERSECTING US 61
SPEED LIMIT 45	ROAD MAINTAINED BY <input checked="" type="checkbox"/> State <input type="checkbox"/> County <input type="checkbox"/> Municipal <input type="checkbox"/> Private Property <input type="checkbox"/> Other				SPEED LIMIT NA INT. DIR. N GEO - CODE NA
TRAFFICWAY <input checked="" type="checkbox"/> One-Way <input type="checkbox"/> Two-Way; Not Divided <input type="checkbox"/> Two-Way; Divided; Unprotected Median <input type="checkbox"/> Other <input type="checkbox"/> Two-Way; Not Divided; Continuous Center Turn Lane <input type="checkbox"/> Two-Way; Divided; Positive Median Barrier <input type="checkbox"/> Unknown			ROAD ALIGNMENT <input checked="" type="checkbox"/> Straight <input type="checkbox"/> Curve <input type="checkbox"/> Unknown (Explain)		ROAD PROFILE <input type="checkbox"/> Level <input checked="" type="checkbox"/> Downhill <input type="checkbox"/> Dip <input type="checkbox"/> Uphill <input type="checkbox"/> Hillcrest <input type="checkbox"/> Unknown (Explain)
INTERSECTION TYPE <input checked="" type="checkbox"/> NA <input type="checkbox"/> 4-way Intersection <input type="checkbox"/> Y-Intersection <input type="checkbox"/> 5-way / More <input type="checkbox"/> Unknown (Explain) <input type="checkbox"/> T-Intersection <input type="checkbox"/> Roundabout <input type="checkbox"/> Other (Explain)			ROAD CONDITION <input checked="" type="checkbox"/> Dry <input type="checkbox"/> Snow <input type="checkbox"/> Slush <input type="checkbox"/> Standing Water <input type="checkbox"/> Sand / Gravel <input type="checkbox"/> Unknown (Explain) <input type="checkbox"/> Wet <input type="checkbox"/> Ice / Frost <input type="checkbox"/> Mud / Dirt <input type="checkbox"/> Moving Water <input type="checkbox"/> Other (Explain)		



**Crash "C":**

Crash "C" occurred on RP 7060 At US 61. It can be located At the gore (shown below) or measured to Route A.

Note: "Intersection Type" is shown as "NA" because this location does not meet the definition of an intersection.

ON RP 7060		RDWY. DIR. N	DISTANCE FROM <input checked="" type="checkbox"/> NA ____ Feet ____ Miles	LOCATION <input type="checkbox"/> After <input type="checkbox"/> NA <input type="checkbox"/> Before <input checked="" type="checkbox"/> At	INTERSECTING US 61
SPEED LIMIT 45	ROAD MAINTAINED BY <input checked="" type="checkbox"/> State <input type="checkbox"/> County <input type="checkbox"/> Municipal <input type="checkbox"/> Private Property <input type="checkbox"/> Other				SPEED LIMIT 65
TRAFFICWAY <input checked="" type="checkbox"/> One-Way <input type="checkbox"/> Two-Way; Not Divided <input type="checkbox"/> Two-Way; Divided; Unprotected Median <input type="checkbox"/> Other <input type="checkbox"/> Two-Way; Not Divided; Continuous Center Turn Lane <input type="checkbox"/> Two-Way; Divided; Positive Median Barrier <input type="checkbox"/> Unknown			ROAD ALIGNMENT <input checked="" type="checkbox"/> Straight <input type="checkbox"/> Curve <input type="checkbox"/> Unknown (Explain)		ROAD PROFILE <input type="checkbox"/> Level <input checked="" type="checkbox"/> Downhill <input type="checkbox"/> Dip <input type="checkbox"/> Uphill <input type="checkbox"/> Hillcrest <input type="checkbox"/> Unknown (Explain)
INTERSECTION TYPE <input checked="" type="checkbox"/> NA <input type="checkbox"/> 4-way Intersection <input type="checkbox"/> Y-Intersection <input type="checkbox"/> 5-way / More <input type="checkbox"/> Unknown (Explain) <input type="checkbox"/> T-Intersection <input type="checkbox"/> Roundabout <input type="checkbox"/> Other (Explain)			ROAD CONDITION <input checked="" type="checkbox"/> Dry <input type="checkbox"/> Snow <input type="checkbox"/> Slush <input type="checkbox"/> Standing Water <input type="checkbox"/> Sand / Gravel <input type="checkbox"/> Unknown (Explain) <input type="checkbox"/> Wet <input type="checkbox"/> Ice / Frost <input type="checkbox"/> Mud / Dirt <input type="checkbox"/> Moving Water <input type="checkbox"/> Other (Explain)		

**Coverleaf Interchange**

**Example #4:**

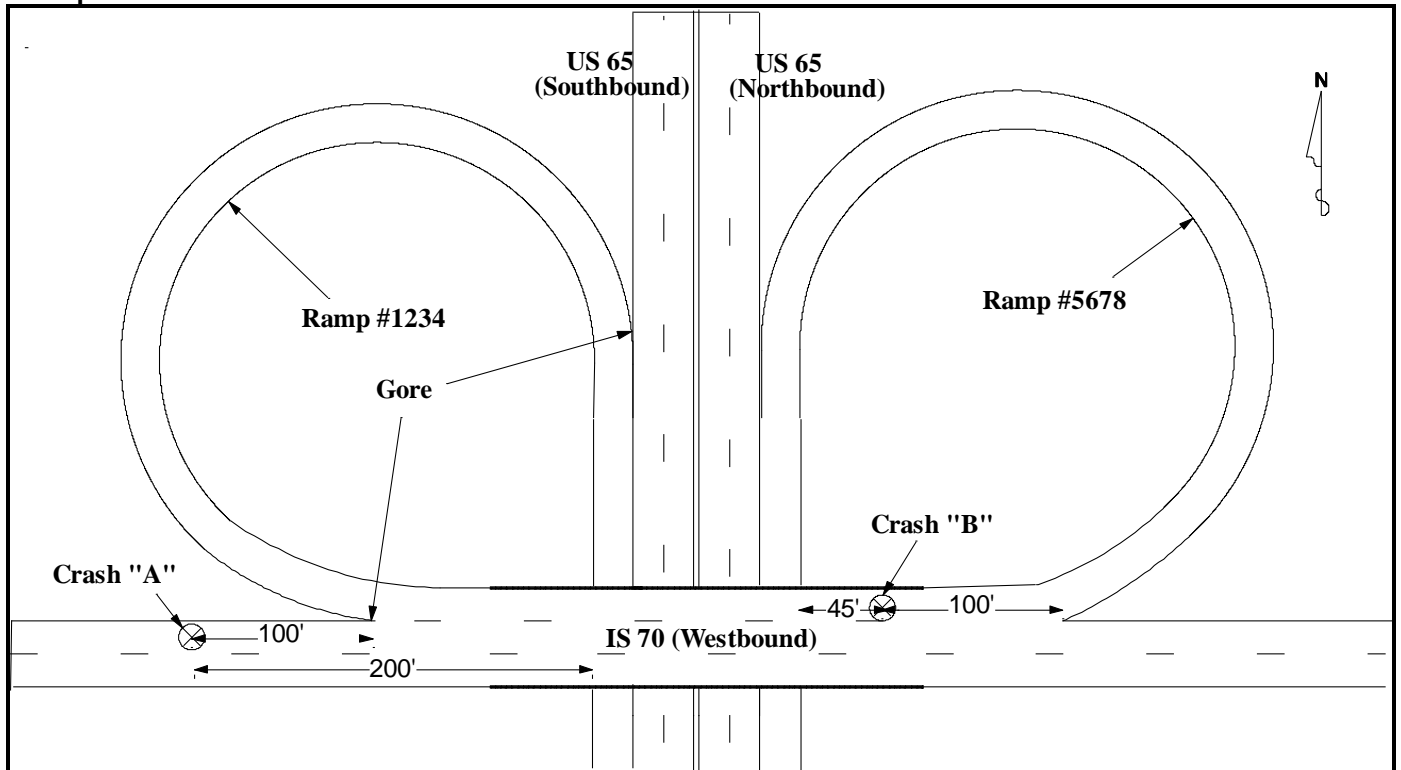

The fact that the crashes occurred within the interchange is immaterial as far as completion of the crash report is concerned. Crash "A" and Crash "B" can be located to the gores of the nearest ramps, to the beginning of the bridge structure, or to the nearest ERM.

**Crash "A":**

Crash "A" can be measured to the gore with Ramp 1234 (shown below), the southbound lanes of US 65, the beginning of the bridge structure (not shown on diagram), or to the nearest ERM (not shown on diagram).

ON IS 70		RDWY. DIR. W	DISTANCE FROM 100 Feet	LOCATION <input checked="" type="checkbox"/> After <input type="checkbox"/> NA <input type="checkbox"/> Before <input type="checkbox"/> NA <input type="checkbox"/> At	INTERSECTING RP 1234
SPEED LIMIT 70	ROAD MAINTAINED BY <input checked="" type="checkbox"/> State <input type="checkbox"/> County <input type="checkbox"/> Municipal <input type="checkbox"/> Private Property <input type="checkbox"/> Other				SPEED LIMIT NA
TRAFFICWAY <input type="checkbox"/> One-Way <input type="checkbox"/> Two-Way, Not Divided <input checked="" type="checkbox"/> Two-Way, Divided; Unprotected Median <input type="checkbox"/> Other <input type="checkbox"/> Two-Way, Not Divided; Continuous Center Turn Lane <input type="checkbox"/> Two-Way, Divided; Positive Median Barrier <input type="checkbox"/> Unknown		ROAD ALIGNMENT <input checked="" type="checkbox"/> Straight <input type="checkbox"/> Curve <input type="checkbox"/> Unknown (Explain)		ROAD PROFILE <input type="checkbox"/> Level <input type="checkbox"/> Downhill <input type="checkbox"/> Dip <input type="checkbox"/> Uphill <input checked="" type="checkbox"/> Hillcrest <input type="checkbox"/> Unknown (Explain)	
INTERSECTION TYPE <input type="checkbox"/> 4-way Intersection <input type="checkbox"/> Y-Intersection <input type="checkbox"/> 5-way / More <input type="checkbox"/> Unknown (Explain) <input type="checkbox"/> T-Intersection <input type="checkbox"/> Roundabout <input type="checkbox"/> Other (Explain)		ROAD CONDITION <input checked="" type="checkbox"/> Dry <input type="checkbox"/> Snow <input type="checkbox"/> Slush <input type="checkbox"/> Standing Water <input type="checkbox"/> Sand / Gravel <input type="checkbox"/> Unknown (Explain) <input type="checkbox"/> Wet <input type="checkbox"/> Ice / Frost <input type="checkbox"/> Mud / Dirt <input type="checkbox"/> Moving Water <input type="checkbox"/> Other (Explain)			

**Crash "B":**

Crash "B" can be measured to the gore with Ramp 5678, the northbound lanes of US 65 (shown below), beginning of the bridge structure (not shown on the diagram), or to the nearest ERM (not shown on the diagram).

ON IS 70		RDWY. DIR. W	DISTANCE FROM 45 Feet	LOCATION <input type="checkbox"/> After <input type="checkbox"/> NA <input checked="" type="checkbox"/> Before <input type="checkbox"/> NA <input type="checkbox"/> At	INTERSECTING US 65
SPEED LIMIT 70	ROAD MAINTAINED BY <input checked="" type="checkbox"/> State <input type="checkbox"/> County <input type="checkbox"/> Municipal <input type="checkbox"/> Private Property <input type="checkbox"/> Other				SPEED LIMIT NA
TRAFFICWAY <input type="checkbox"/> One-Way <input type="checkbox"/> Two-Way, Not Divided <input checked="" type="checkbox"/> Two-Way, Divided; Unprotected Median <input type="checkbox"/> Other <input type="checkbox"/> Two-Way, Not Divided; Continuous Center Turn Lane <input type="checkbox"/> Two-Way, Divided; Positive Median Barrier <input type="checkbox"/> Unknown		ROAD ALIGNMENT <input checked="" type="checkbox"/> Straight <input type="checkbox"/> Curve <input type="checkbox"/> Unknown (Explain)		ROAD PROFILE <input type="checkbox"/> Level <input type="checkbox"/> Downhill <input type="checkbox"/> Dip <input type="checkbox"/> Uphill <input checked="" type="checkbox"/> Hillcrest <input type="checkbox"/> Unknown (Explain)	
INTERSECTION TYPE <input type="checkbox"/> 4-way Intersection <input type="checkbox"/> Y-Intersection <input type="checkbox"/> 5-way / More <input type="checkbox"/> Unknown (Explain) <input type="checkbox"/> T-Intersection <input type="checkbox"/> Roundabout <input type="checkbox"/> Other (Explain)		ROAD CONDITION <input checked="" type="checkbox"/> Dry <input type="checkbox"/> Snow <input type="checkbox"/> Slush <input type="checkbox"/> Standing Water <input type="checkbox"/> Sand / Gravel <input type="checkbox"/> Unknown (Explain) <input type="checkbox"/> Wet <input type="checkbox"/> Ice / Frost <input type="checkbox"/> Mud / Dirt <input type="checkbox"/> Moving Water <input type="checkbox"/> Other (Explain)			

**Example #5:**

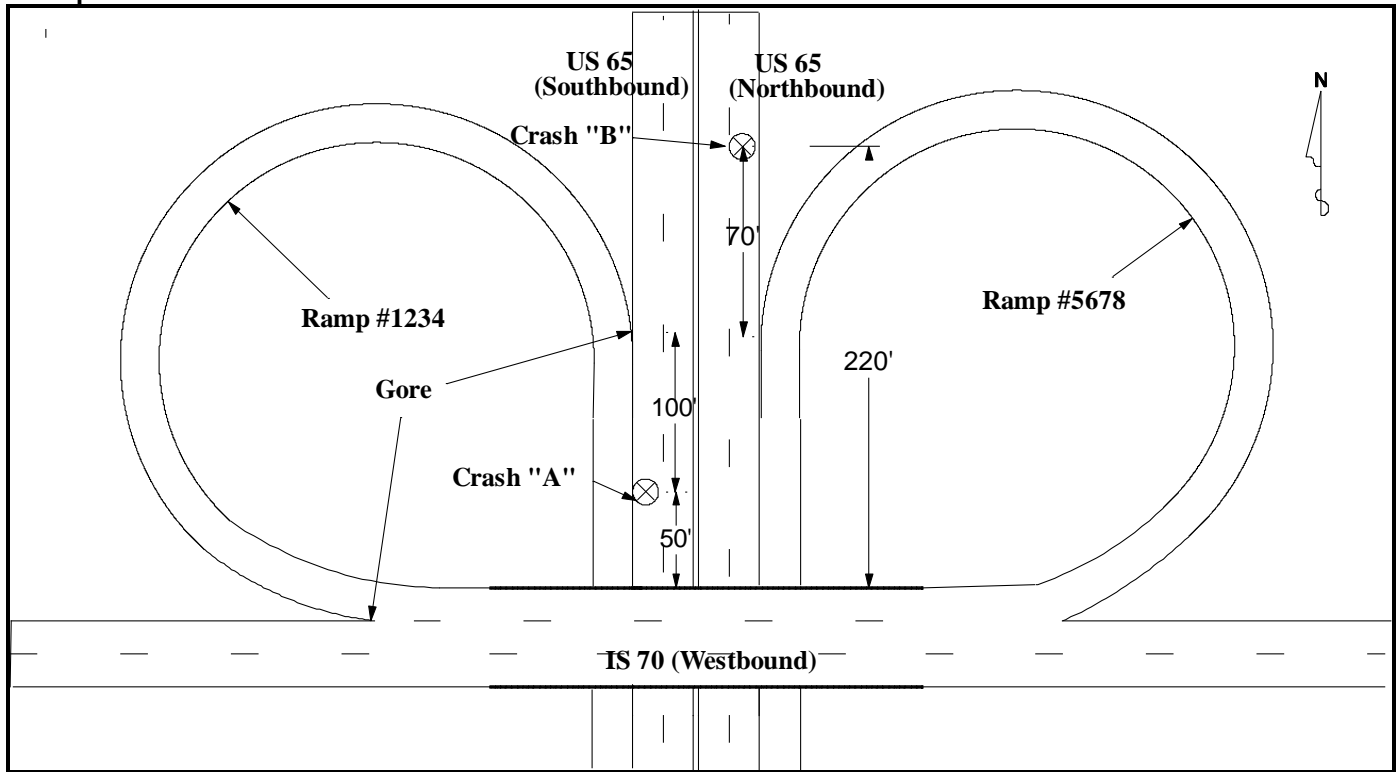

The fact that the crashes occurred within the interchange is immaterial as far as completion of the crash report is concerned. The crashes can be located to the nearest roadway (westbound lane of IS 70) or to the painted gore on the corresponding ramp.

**Crash "A":**

Crash "A" can be measured to IS 70 (shown below) or the gore with Ramp #1234.

ON US 65		RDWY. DIR. S	DISTANCE FROM 50 <input type="checkbox"/> NA Feet Miles	LOCATION <input type="checkbox"/> After <input type="checkbox"/> NA <input checked="" type="checkbox"/> Before <input type="checkbox"/> At	INTERSECTING IS 70	SPEED LIMIT NA	INT. DIR. W	GEO - CODE NA
SPEED LIMIT 65		ROAD MAINTAINED BY <input checked="" type="checkbox"/> State <input type="checkbox"/> County <input type="checkbox"/> Municipal <input type="checkbox"/> Private Property <input type="checkbox"/> Other		TRAFFICWAY <input type="checkbox"/> One-Way <input checked="" type="checkbox"/> Two-Way; Not Divided <input type="checkbox"/> Two-Way; Divided; Unprotected Median <input type="checkbox"/> Other <input type="checkbox"/> Two-Way; Not Divided; Continuous Center Turn Lane <input type="checkbox"/> Two-Way; Divided; Positive Median Barrier <input type="checkbox"/> Unknown		ROAD ALIGNMENT <input checked="" type="checkbox"/> Straight <input type="checkbox"/> Curve <input type="checkbox"/> Unknown (Explain)		ROAD PROFILE <input checked="" type="checkbox"/> Level <input type="checkbox"/> Downhill <input type="checkbox"/> Dip <input type="checkbox"/> Uphill <input type="checkbox"/> Hillcrest <input type="checkbox"/> Unknown (Explain)
INTERSECTION TYPE <input type="checkbox"/> 4-way Intersection <input type="checkbox"/> Y-Intersection <input type="checkbox"/> 5-way / More <input type="checkbox"/> Unknown (Explain) <input type="checkbox"/> T-Intersection <input type="checkbox"/> Roundabout <input type="checkbox"/> Other (Explain)		ROAD CONDITION <input checked="" type="checkbox"/> Dry <input type="checkbox"/> Snow <input type="checkbox"/> Slush <input type="checkbox"/> Standing Water <input type="checkbox"/> Sand / Gravel <input type="checkbox"/> Unknown (Explain) <input type="checkbox"/> Wet <input type="checkbox"/> Ice / Frost <input type="checkbox"/> Mud / Dirt <input type="checkbox"/> Moving Water <input type="checkbox"/> Other (Explain)						

**Crash "B":**

Crash "B" can be measured to IS 70 or the gore with Ramp #5678 (shown below).

ON US 65		RDWY. DIR. N	DISTANCE FROM 70 <input type="checkbox"/> NA Feet Miles	LOCATION <input checked="" type="checkbox"/> After <input type="checkbox"/> NA <input type="checkbox"/> Before <input type="checkbox"/> At	INTERSECTING RP 5678	SPEED LIMIT NA	INT. DIR. W	GEO - CODE NA
SPEED LIMIT 65		ROAD MAINTAINED BY <input checked="" type="checkbox"/> State <input type="checkbox"/> County <input type="checkbox"/> Municipal <input type="checkbox"/> Private Property <input type="checkbox"/> Other		TRAFFICWAY <input type="checkbox"/> One-Way <input type="checkbox"/> Two-Way; Not Divided <input type="checkbox"/> Two-Way; Divided; Unprotected Median <input type="checkbox"/> Other <input type="checkbox"/> Two-Way; Not Divided; Continuous Center Turn Lane <input checked="" type="checkbox"/> Two-Way; Divided; Positive Median Barrier <input type="checkbox"/> Unknown		ROAD ALIGNMENT <input checked="" type="checkbox"/> Straight <input type="checkbox"/> Curve <input type="checkbox"/> Unknown (Explain)		ROAD PROFILE <input checked="" type="checkbox"/> Level <input type="checkbox"/> Downhill <input type="checkbox"/> Dip <input type="checkbox"/> Uphill <input type="checkbox"/> Hillcrest <input type="checkbox"/> Unknown (Explain)
INTERSECTION TYPE <input type="checkbox"/> 4-way Intersection <input type="checkbox"/> Y-Intersection <input type="checkbox"/> 5-way / More <input type="checkbox"/> Unknown (Explain) <input type="checkbox"/> T-Intersection <input type="checkbox"/> Roundabout <input type="checkbox"/> Other (Explain)		ROAD CONDITION <input checked="" type="checkbox"/> Dry <input type="checkbox"/> Snow <input type="checkbox"/> Slush <input type="checkbox"/> Standing Water <input type="checkbox"/> Sand / Gravel <input type="checkbox"/> Unknown (Explain) <input type="checkbox"/> Wet <input type="checkbox"/> Ice / Frost <input type="checkbox"/> Mud / Dirt <input type="checkbox"/> Moving Water <input type="checkbox"/> Other (Explain)						

**Example #6:**

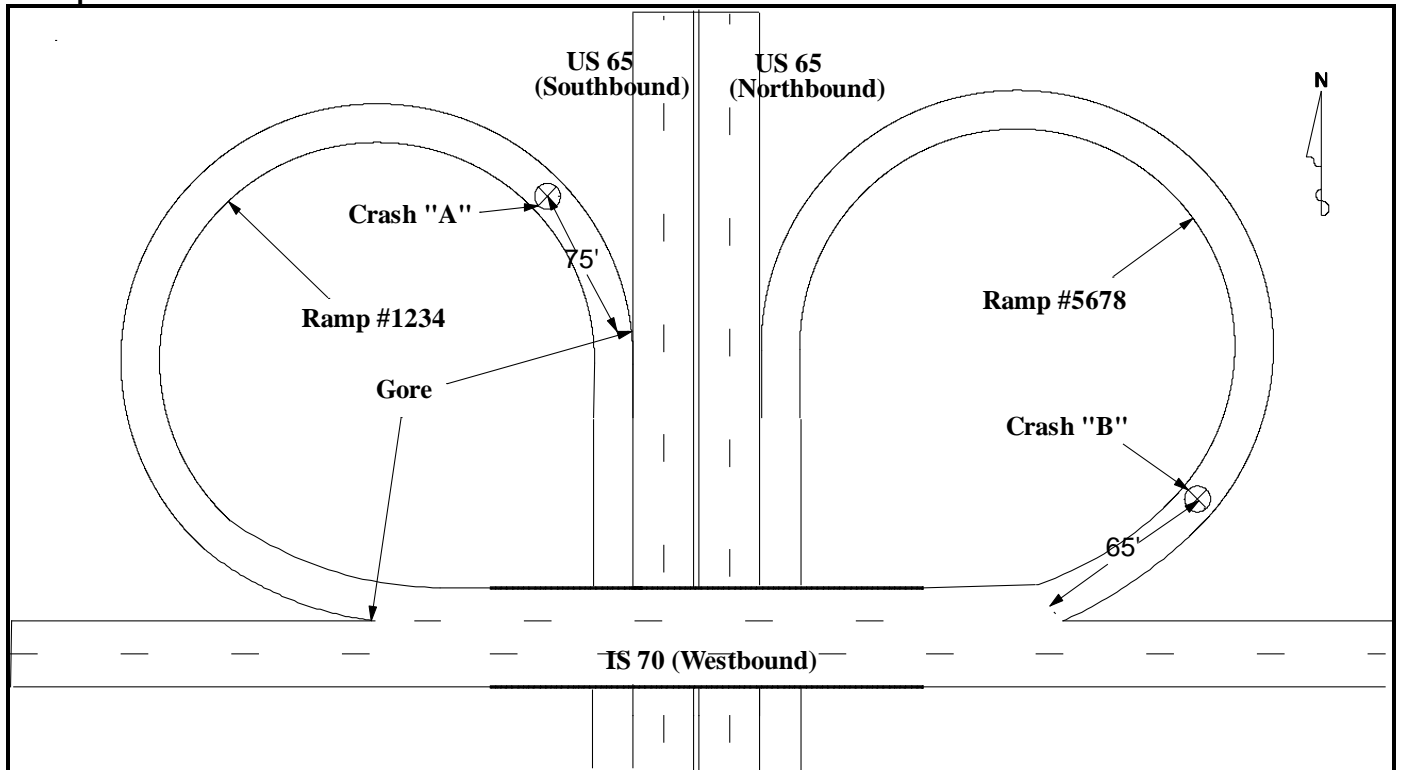

The fact that the crashes occurred within the interchange is immaterial as far as completion of the crash report is concerned. The crashes can be located to the painted gore on either end of the ramp. The Roadway Direction indicates the direction of the roadway to which the ramp is entering.

**Crash "A":**

Crash "A" can be measured to the gore with southbound US 65 (shown below) or back around the ramp to the gore with westbound IS 70 (not shown on diagram). The Roadway Direction is "S" because the ramp is entering US 65 Southbound.

ON RP 1234		RDWY. DIR. S	DISTANCE FROM 75 Feet	LOCATION <input type="checkbox"/> After <input checked="" type="checkbox"/> Before <input type="checkbox"/> At	INTERSECTING US 65
SPEED LIMIT 70	ROAD MAINTAINED BY <input checked="" type="checkbox"/> State <input type="checkbox"/> County <input type="checkbox"/> Municipal <input type="checkbox"/> Private Property <input type="checkbox"/> Other				SPEED LIMIT NA INT. DIR. S GEO - CODE NA
TRAFFICWAY <input checked="" type="checkbox"/> One-Way <input type="checkbox"/> Two-Way; Not Divided <input type="checkbox"/> Two-Way; Divided; Unprotected Median <input type="checkbox"/> Other <input type="checkbox"/> Two-Way; Not Divided; Continuous Center Turn Lane <input type="checkbox"/> Two-Way; Divided; Positive Median Barrier <input type="checkbox"/> Unknown			ROAD ALIGNMENT <input type="checkbox"/> Straight <input checked="" type="checkbox"/> Curve <input type="checkbox"/> Unknown (Explain)		ROAD PROFILE <input checked="" type="checkbox"/> Level <input type="checkbox"/> Downhill <input type="checkbox"/> Dip <input type="checkbox"/> Uphill <input type="checkbox"/> Hillcrest <input type="checkbox"/> Unknown (Explain)
INTERSECTION TYPE <input checked="" type="checkbox"/> NA <input type="checkbox"/> 4-way Intersection <input type="checkbox"/> Y-Intersection <input type="checkbox"/> 5-way / More <input type="checkbox"/> Unknown (Explain) <input type="checkbox"/> T-Intersection <input type="checkbox"/> Roundabout <input type="checkbox"/> Other (Explain)			ROAD CONDITION <input checked="" type="checkbox"/> Dry <input type="checkbox"/> Snow <input type="checkbox"/> Slush <input type="checkbox"/> Standing Water <input type="checkbox"/> Sand / Gravel <input type="checkbox"/> Unknown (Explain) <input type="checkbox"/> Wet <input type="checkbox"/> Ice / Frost <input type="checkbox"/> Mud / Dirt <input type="checkbox"/> Moving Water <input type="checkbox"/> Other (Explain)		

**Crash "B":**

Crash "B" can be measured to the gore with westbound IS 70 (shown below) or back around the ramp to the gore with northbound US 65 (not shown on diagram). The Roadway Direction is "W" because the ramp is entering IS-70 Westbound.

ON RP 5678		RDWY. DIR. W	DISTANCE FROM 65 Feet	LOCATION <input type="checkbox"/> After <input checked="" type="checkbox"/> Before <input type="checkbox"/> At	INTERSECTING IS 70
SPEED LIMIT 65	ROAD MAINTAINED BY <input checked="" type="checkbox"/> State <input type="checkbox"/> County <input type="checkbox"/> Municipal <input type="checkbox"/> Private Property <input type="checkbox"/> Other				SPEED LIMIT NA INT. DIR. W GEO - CODE NA
TRAFFICWAY <input checked="" type="checkbox"/> One-Way <input type="checkbox"/> Two-Way; Not Divided <input type="checkbox"/> Two-Way; Divided; Unprotected Median <input type="checkbox"/> Other <input type="checkbox"/> Two-Way; Not Divided; Continuous Center Turn Lane <input type="checkbox"/> Two-Way; Divided; Positive Median Barrier <input type="checkbox"/> Unknown			ROAD ALIGNMENT <input type="checkbox"/> Straight <input checked="" type="checkbox"/> Curve <input type="checkbox"/> Unknown (Explain)		ROAD PROFILE <input type="checkbox"/> Level <input type="checkbox"/> Downhill <input type="checkbox"/> Dip <input checked="" type="checkbox"/> Uphill <input type="checkbox"/> Hillcrest <input type="checkbox"/> Unknown (Explain)
INTERSECTION TYPE <input checked="" type="checkbox"/> NA <input type="checkbox"/> 4-way Intersection <input type="checkbox"/> Y-Intersection <input type="checkbox"/> 5-way / More <input type="checkbox"/> Unknown (Explain) <input type="checkbox"/> T-Intersection <input type="checkbox"/> Roundabout <input type="checkbox"/> Other (Explain)			ROAD CONDITION <input checked="" type="checkbox"/> Dry <input type="checkbox"/> Snow <input type="checkbox"/> Slush <input type="checkbox"/> Standing Water <input type="checkbox"/> Sand / Gravel <input type="checkbox"/> Unknown (Explain) <input type="checkbox"/> Wet <input type="checkbox"/> Ice / Frost <input type="checkbox"/> Mud / Dirt <input type="checkbox"/> Moving Water <input type="checkbox"/> Other (Explain)		

## Diverging Diamond Interchange

Crashes are located in and around a diverging diamond interchange in the same method as any other interchange. Examples are provided due to the unique characteristics of this type of interchange. This also provides examples of locating crashes on overlapping ramps. In the case of overlapping ramps, it may be necessary to examine more than one roadway listing from the [MoDOT Interactive Mapping Tool](#) in order to determine the numbers of each ramp once they separate.

### Example #7

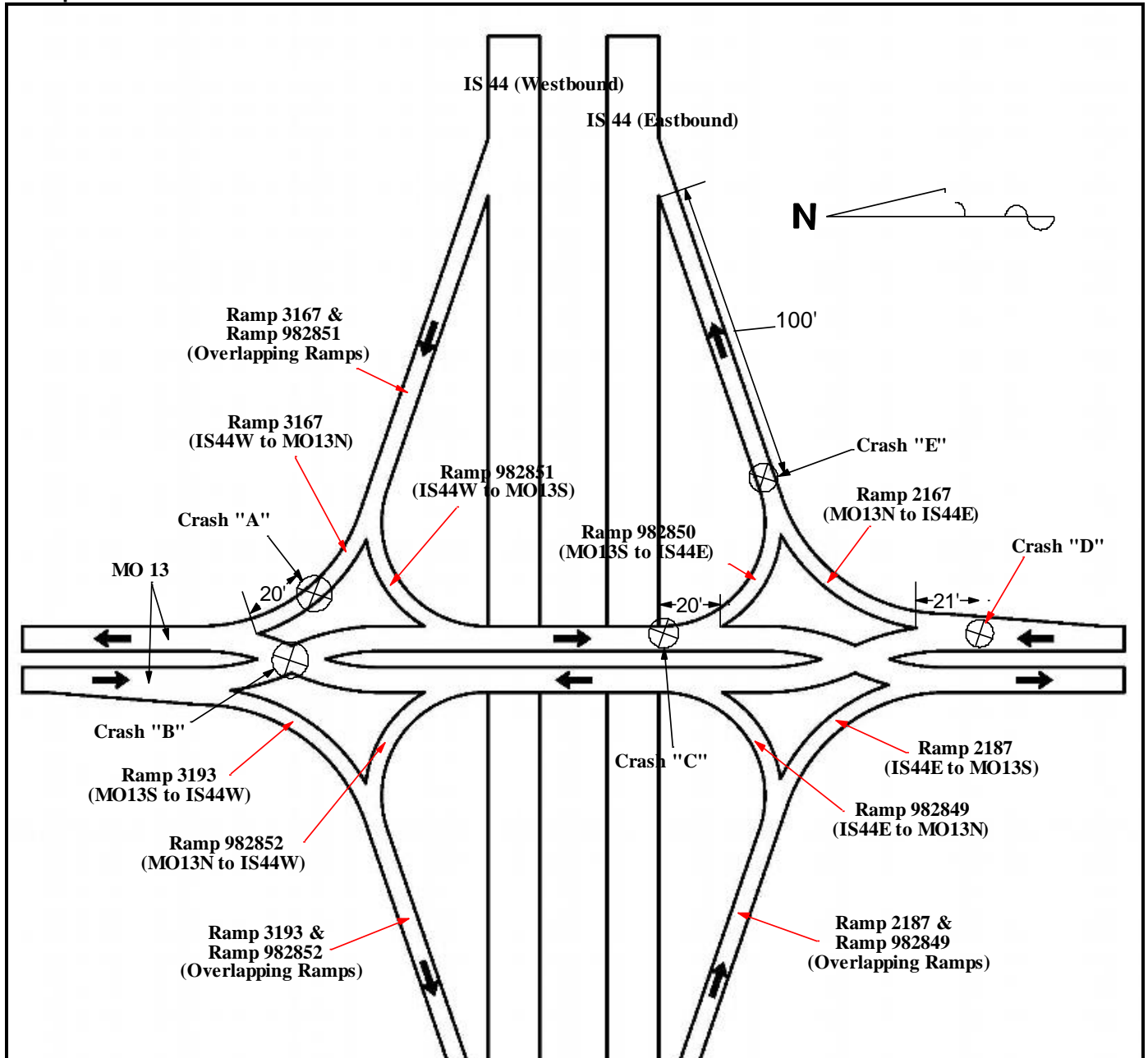

The fact that the crashes occurred within the interchange is immaterial as far as completion of the crash report is concerned. Crashes "C" and "D" can be located to the nearest roadways (including ramps) or to the beginning of the bridge structure. Crash "A" is located on the ramp and can only be measured to the nearest painted gore with MO 13. Crash "E" is located on either of the overlapping ramps and can only be measured to the painted gore with IS 44. Crash "B" is located within the intersection of MO 13 North and MO 13 South.

An example from the [MoDOT Interactive Mapping Tool](#) showing MO 13 N as it approaches, crosses, and departs IS 44 is as follows and is used in the examples for Crashes "A," "B," and "D."

<b>RP</b>	<b>2167</b>	<b>MO13N TO IS44E</b>	<b>(E)</b>	
<b>MO</b>	<b>13</b>		<b>(S)</b>	<b>(SJ)</b>
<b>CST</b>	<b>KANSAS EXPY</b>		<b>(S)</b>	<b>(11.897)</b>
<b>RP</b>	<b>982849</b>	<b>IS44E TO MO13N</b>	<b>(N)</b>	
<b>BRIDGE</b>	<b>A0443</b>	<b>IS 44</b>		
<b>IS</b>	<b>44</b>		<b>(E)</b>	
<b>IS</b>	<b>44</b>		<b>(W)</b>	
<b>RP</b>	<b>982852</b>	<b>MO13N TO IS44W</b>	<b>(W)</b>	
<b>MO</b>	<b>13</b>		<b>(S)</b>	<b>(NJ)</b>
<b>CST</b>	<b>KANSAS EXPY</b>		<b>(S)</b>	<b>(12.003)</b>
<b>RP</b>	<b>3167</b>	<b>IS44W TO MO13N</b>	<b>(N)</b>	
<b>CST</b>	<b>KANSAS EXPY</b>		<b>(N)</b>	<b>(12.021)</b>

**Crash "A":**

Crash "A" is located on Ramp 3167 (Roadway Direction - "N") and can only be measured to the nearest painted gore at the northbound lanes of MO 13 (as shown in the diagram and below).

ON RP 3167		RDWY. DIR. N	DISTANCE FROM 20 <input type="checkbox"/> NA Feet Miles	LOCATION <input type="checkbox"/> After <input type="checkbox"/> NA <input checked="" type="checkbox"/> Before <input type="checkbox"/> At	INTERSECTING MO 13
SPEED LIMIT 60	ROAD MAINTAINED BY <input checked="" type="checkbox"/> State <input type="checkbox"/> County <input type="checkbox"/> Municipal <input type="checkbox"/> Private Property <input type="checkbox"/> Other				SPEED LIMIT NA
					INT. DIR. N
					GEO - CODE NA
TRAFFICWAY <input checked="" type="checkbox"/> One-Way <input type="checkbox"/> Two-Way, Not Divided <input type="checkbox"/> Two-Way, Divided; Unprotected Median <input type="checkbox"/> Other <input type="checkbox"/> Two-Way, Not Divided; Continuous Center Turn Lane <input type="checkbox"/> Two-Way, Divided; Positive Median Barrier <input type="checkbox"/> Unknown			ROAD ALIGNMENT <input type="checkbox"/> Straight <input checked="" type="checkbox"/> Curve <input type="checkbox"/> Unknown (Explain)		ROAD PROFILE <input checked="" type="checkbox"/> Level <input type="checkbox"/> Downhill <input type="checkbox"/> Dip <input type="checkbox"/> Uphill <input type="checkbox"/> Hillcrest <input type="checkbox"/> Unknown (Explain)

**Crash "B":**

Crash "B" is located within the intersection of the northbound and southbound lanes of the MO 13 (North Junction). The crash can be shown as occurring On the northbound lanes of MO 13 (shown below) or the southbound lanes of MO 13.

ON MO 13		RDWY. DIR. N	DISTANCE FROM <input checked="" type="checkbox"/> NA Feet Miles	LOCATION <input type="checkbox"/> After <input type="checkbox"/> NA <input checked="" type="checkbox"/> Before <input checked="" type="checkbox"/> At	INTERSECTING MO 13 (NJ)
SPEED LIMIT 45	ROAD MAINTAINED BY <input checked="" type="checkbox"/> State <input type="checkbox"/> County <input type="checkbox"/> Municipal <input type="checkbox"/> Private Property <input type="checkbox"/> Other				SPEED LIMIT 45
					INT. DIR. S
					GEO - CODE NA
TRAFFICWAY <input type="checkbox"/> One-Way <input type="checkbox"/> Two-Way, Not Divided <input type="checkbox"/> Two-Way, Divided; Unprotected Median <input type="checkbox"/> Other <input type="checkbox"/> Two-Way, Not Divided; Continuous Center Turn Lane <input checked="" type="checkbox"/> Two-Way, Divided; Positive Median Barrier <input type="checkbox"/> Unknown			ROAD ALIGNMENT <input checked="" type="checkbox"/> Straight <input type="checkbox"/> Curve <input type="checkbox"/> Unknown (Explain)		ROAD PROFILE <input checked="" type="checkbox"/> Level <input type="checkbox"/> Downhill <input type="checkbox"/> Dip <input type="checkbox"/> Uphill <input type="checkbox"/> Hillcrest <input type="checkbox"/> Unknown (Explain)
INTERSECTION TYPE <input checked="" type="checkbox"/> 4-way Intersection <input type="checkbox"/> Y-Intersection <input type="checkbox"/> 5-way / More <input type="checkbox"/> Unknown (Explain) <input type="checkbox"/> T-Intersection <input type="checkbox"/> Roundabout <input type="checkbox"/> Other (Explain)			ROAD CONDITION <input checked="" type="checkbox"/> Dry <input type="checkbox"/> Snow <input type="checkbox"/> Slush <input type="checkbox"/> Standing Water <input type="checkbox"/> Sand / Gravel <input type="checkbox"/> Unknown (Explain) <input type="checkbox"/> Wet <input type="checkbox"/> Ice / Frost <input type="checkbox"/> Mud / Dirt <input type="checkbox"/> Moving Water <input type="checkbox"/> Other (Explain)		

**Crash "C":**

Crash "C" is located on MO 13 (Roadway Direction - "S") and can be measured to the nearest ramp (as shown in the diagram and below), the beginning of the nearest bridge structure (not shown), the eastbound lanes of IS 44 (not shown), or the intersection of the northbound lanes of MO 13 at the South Junction (not shown).

ON MO 13		RDWY. DIR. S	DISTANCE FROM 20	LOCATION <input type="checkbox"/> After <input type="checkbox"/> NA <input checked="" type="checkbox"/> Before <input type="checkbox"/> At	INTERSECTING RP 982850
SPEED LIMIT 45	ROAD MAINTAINED BY <input checked="" type="checkbox"/> State <input type="checkbox"/> County <input type="checkbox"/> Municipal <input type="checkbox"/> Private Property <input type="checkbox"/> Other		<input type="checkbox"/> NA Feet Miles		SPEED LIMIT NA
TRAFFICWAY <input type="checkbox"/> One-Way <input type="checkbox"/> Two-Way; Not Divided <input type="checkbox"/> Two-Way; Divided; Unprotected Median <input type="checkbox"/> Other <input type="checkbox"/> Two-Way; Not Divided; Continuous Center Turn Lane <input checked="" type="checkbox"/> Two-Way; Divided; Positive Median Barrier <input type="checkbox"/> Unknown			ROAD ALIGNMENT <input checked="" type="checkbox"/> Straight <input type="checkbox"/> Curve <input type="checkbox"/> Unknown (Explain)	ROAD PROFILE <input checked="" type="checkbox"/> Level <input type="checkbox"/> Downhill <input type="checkbox"/> Dip <input type="checkbox"/> Uphill <input type="checkbox"/> Hillcrest <input type="checkbox"/> Unknown (Explain)	

**Crash "D":**

Crash "D" is located on MO 13 (Roadway Direction - "N") and can be measured to the nearest ramp (as shown in the diagram and below) or the intersection of the southbound lanes of MO 13 at the South Junction (not shown).

ON MO 13		RDWY. DIR. N	DISTANCE FROM 21	LOCATION <input type="checkbox"/> After <input type="checkbox"/> NA <input checked="" type="checkbox"/> Before <input type="checkbox"/> At	INTERSECTING RP 2167
SPEED LIMIT 45	ROAD MAINTAINED BY <input checked="" type="checkbox"/> State <input type="checkbox"/> County <input type="checkbox"/> Municipal <input type="checkbox"/> Private Property <input type="checkbox"/> Other		<input type="checkbox"/> NA Feet Miles		SPEED LIMIT NA
TRAFFICWAY <input type="checkbox"/> One-Way <input type="checkbox"/> Two-Way; Not Divided <input type="checkbox"/> Two-Way; Divided; Unprotected Median <input type="checkbox"/> Other <input type="checkbox"/> Two-Way; Not Divided; Continuous Center Turn Lane <input checked="" type="checkbox"/> Two-Way; Divided; Positive Median Barrier <input type="checkbox"/> Unknown			ROAD ALIGNMENT <input checked="" type="checkbox"/> Straight <input type="checkbox"/> Curve <input type="checkbox"/> Unknown (Explain)	ROAD PROFILE <input checked="" type="checkbox"/> Level <input type="checkbox"/> Downhill <input type="checkbox"/> Dip <input type="checkbox"/> Uphill <input type="checkbox"/> Hillcrest <input type="checkbox"/> Unknown (Explain)	

**Crash "E":**

Crash "E" is located either on Ramp 2167 or Ramp 982850 (because they overlap at the crash scene) and can only be measured to the nearest painted gore with IS 44 (as shown in the diagram and below).

ON RP 2167		RDWY. DIR. E	DISTANCE FROM 100	LOCATION <input type="checkbox"/> After <input type="checkbox"/> NA <input checked="" type="checkbox"/> Before <input type="checkbox"/> At	INTERSECTING IS 44
SPEED LIMIT 45	ROAD MAINTAINED BY <input checked="" type="checkbox"/> State <input type="checkbox"/> County <input type="checkbox"/> Municipal <input type="checkbox"/> Private Property <input type="checkbox"/> Other		<input type="checkbox"/> NA Feet Miles		SPEED LIMIT NA
TRAFFICWAY <input checked="" type="checkbox"/> One-Way <input type="checkbox"/> Two-Way; Not Divided <input type="checkbox"/> Two-Way; Divided; Unprotected Median <input type="checkbox"/> Other <input type="checkbox"/> Two-Way; Not Divided; Continuous Center Turn Lane <input type="checkbox"/> Two-Way; Divided; Positive Median Barrier <input type="checkbox"/> Unknown			ROAD ALIGNMENT <input checked="" type="checkbox"/> Straight <input type="checkbox"/> Curve <input type="checkbox"/> Unknown (Explain)	ROAD PROFILE <input type="checkbox"/> Level <input checked="" type="checkbox"/> Downhill <input type="checkbox"/> Dip <input type="checkbox"/> Uphill <input type="checkbox"/> Hillcrest <input type="checkbox"/> Unknown (Explain)	

## Directional or Combination Interchange

Crashes are located in and around a directional interchange in the same method as any other interchange. Examples are provided due to the unique characteristics of this type of interchange. This also provides examples of locating crashes on overlapping ramps. In the case of overlapping ramps, it may be necessary to examine more than one roadway listing from the [MoDOT Interactive Mapping Tool](#) in order to determine the numbers of each ramp once they separate.

### Example #8

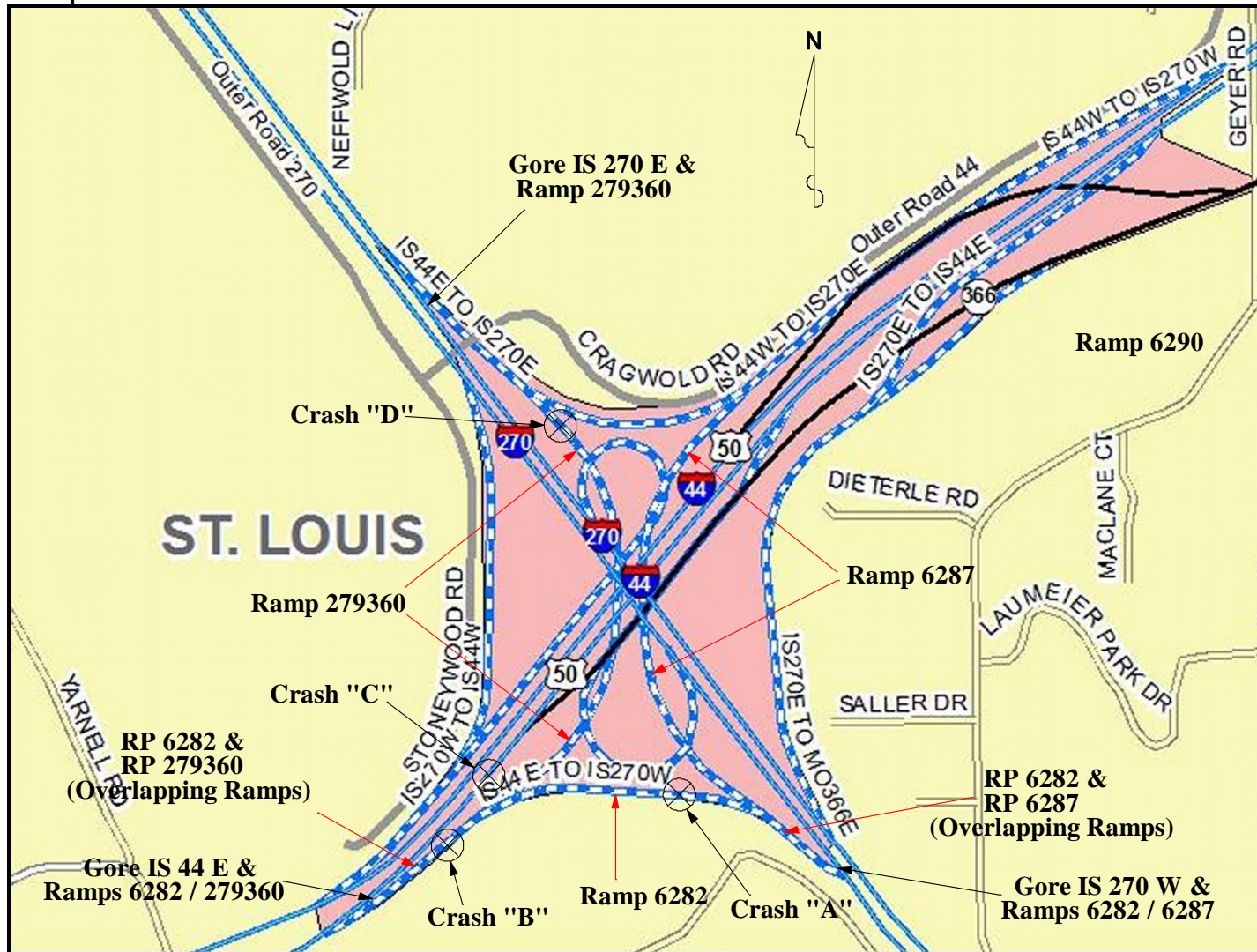

The fact that the crashes occurred within the interchange is immaterial as far as completion of the crash report is concerned. Crashes "A," "B," and "D" are located on the appropriate ramp and measured to the nearest gore with IS 44 or IS 270. Crash "C" is located on IS 44 and is measured to the nearest ramp, roadway, ERM, or to IS 270.



An example from the [MoDOT Interactive Mapping Tool](#) showing IS 44 E is as follows and is used in the following examples.

<u>RP</u>	<u>6282</u>	IS44E TO IS270W	<u>(W)</u>	
<u>RP</u>	<u>279360</u>	IS44E TO IS270E	<u>(E)</u>	<u>(WJ)</u>
<u>MO</u>	<u>366</u>		<u>(E)</u>	
<u>RP</u>	<u>279360</u>	IS44E TO IS270E	<u>(E)</u>	<u>(EJ)</u>
<u>IS</u>	<u>270</u>		<u>(W)</u>	
<u>IS</u>	<u>270</u>		<u>(E)</u>	
<u>RP</u>	<u>6287</u>	IS44W TO IS270W	<u>(W)</u>	
<u>RP</u>	<u>6292</u>	IS270W TO IS44E	<u>(E)</u>	
<u>MO</u>	<u>366</u>		<u>(W)</u>	
<u>RP</u>	<u>6290</u>	IS270E TO IS44E	<u>(E)</u>	

**Crash "A":**

Crash "A" is located On Ramp 6282 (Roadway Direction either "E" or "W") and can be measured back to the gore with IS 44 E or to the gore with IS 270 W (shown below). In the case of overlapping ramps, it may be necessary to examine more than one listing from the [MoDOT Interactive Mapping Tool](#) in order to determine the ramp number once overlapping ramps separate. In this case, Ramps 6282 and 279360 overlap for some distance and then separate prior to the location of Crash "A." Examination of the listing for either IS 270 E or IS 270 W will assist in determining that the crash occurred on Ramp 6282.

ON RP 6282		RDWY. DIR. W	DISTANCE FROM <input type="checkbox"/> NA 0.2 Feet Miles	LOCATION <input type="checkbox"/> After <input type="checkbox"/> NA <input checked="" type="checkbox"/> Before <input type="checkbox"/> At	INTERSECTING IS 270	SPEED LIMIT NA	INT. DIR. W	GEO - CODE NA	
SPEED LIMIT 60	ROAD MAINTAINED BY <input checked="" type="checkbox"/> State <input type="checkbox"/> County <input type="checkbox"/> Municipal <input type="checkbox"/> Private Property <input type="checkbox"/> Other		TRAFFICWAY <input checked="" type="checkbox"/> One-Way <input type="checkbox"/> Two-Way; Not Divided <input type="checkbox"/> Two-Way; Divided; Unprotected Median <input type="checkbox"/> Other <input type="checkbox"/> Two-Way; Not Divided; Continuous Center Turn Lane <input type="checkbox"/> Two-Way; Divided; Positive Median Barrier <input type="checkbox"/> Unknown		ROAD ALIGNMENT <input type="checkbox"/> Straight <input checked="" type="checkbox"/> Curve <input type="checkbox"/> Unknown (Explain)		ROAD PROFILE <input checked="" type="checkbox"/> Level <input type="checkbox"/> Downhill <input type="checkbox"/> Dip <input type="checkbox"/> Uphill <input type="checkbox"/> Hillcrest <input type="checkbox"/> Unknown (Explain)		

**Crash "B":**

Ramps 6282 and 279360 overlap at the location of Crash "B." Consequently, Crash "B" is located On Ramp 6282 or Ramp 279360 (Roadway Direction - "E"). If shown on Ramp 6282, it can be measured back to the gore with IS 44 E (shown below) or to the gore with IS 270 W. If shown on Ramp 279360, it can be measured back to the gore with IS 44 E or to the gore with IS 270 E (shown below).

ON RP 6282		RDWY. DIR. W	DISTANCE FROM <input type="checkbox"/> NA 0.1 Feet Miles	LOCATION <input checked="" type="checkbox"/> After <input type="checkbox"/> NA <input type="checkbox"/> Before <input type="checkbox"/> At	INTERSECTING IS 44	SPEED LIMIT NA	INT. DIR. E	GEO - CODE NA	
SPEED LIMIT 60	ROAD MAINTAINED BY <input checked="" type="checkbox"/> State <input type="checkbox"/> County <input type="checkbox"/> Municipal <input type="checkbox"/> Private Property <input type="checkbox"/> Other		TRAFFICWAY <input type="checkbox"/> One-Way <input type="checkbox"/> Two-Way; Not Divided <input type="checkbox"/> Two-Way; Divided; Unprotected Median <input type="checkbox"/> Other <input type="checkbox"/> Two-Way; Not Divided; Continuous Center Turn Lane <input type="checkbox"/> Two-Way; Divided; Positive Median Barrier <input type="checkbox"/> Unknown		ROAD ALIGNMENT <input type="checkbox"/> Straight <input type="checkbox"/> Curve <input type="checkbox"/> Unknown (Explain)		ROAD PROFILE <input type="checkbox"/> Level <input type="checkbox"/> Downhill <input type="checkbox"/> Dip <input type="checkbox"/> Uphill <input type="checkbox"/> Hillcrest <input type="checkbox"/> Unknown (Explain)		

ON RP 279360		RDWY. DIR. E	DISTANCE FROM <input type="checkbox"/> NA 0.5 Feet Miles	LOCATION <input type="checkbox"/> After <input type="checkbox"/> NA <input checked="" type="checkbox"/> Before <input type="checkbox"/> At	INTERSECTING IS 270	SPEED LIMIT NA	INT. DIR. E	GEO - CODE NA	
SPEED LIMIT 60	ROAD MAINTAINED BY <input checked="" type="checkbox"/> State <input type="checkbox"/> County <input type="checkbox"/> Municipal <input type="checkbox"/> Private Property <input type="checkbox"/> Other		TRAFFICWAY <input type="checkbox"/> One-Way <input type="checkbox"/> Two-Way; Not Divided <input type="checkbox"/> Two-Way; Divided; Unprotected Median <input type="checkbox"/> Other <input type="checkbox"/> Two-Way; Not Divided; Continuous Center Turn Lane <input type="checkbox"/> Two-Way; Divided; Positive Median Barrier <input type="checkbox"/> Unknown		ROAD ALIGNMENT <input type="checkbox"/> Straight <input type="checkbox"/> Curve <input type="checkbox"/> Unknown (Explain)		ROAD PROFILE <input type="checkbox"/> Level <input type="checkbox"/> Downhill <input type="checkbox"/> Dip <input type="checkbox"/> Uphill <input type="checkbox"/> Hillcrest <input type="checkbox"/> Unknown (Explain)		

**Crash "C":**

Crash "C" is located On IS 44 (Roadway Direction - "E") and can be measured back to the gore with Ramp 6282 (shown below) or the west junction (WJ) of Ramp 279360 since the two ramps overlap at this location (shown below), to the gore with MO 366, to the east junction (EJ) with Ramp 279360 (where the ramp goes over IS 44 E), to IS 270 W, or to the nearest ERM.

ON IS 44		RDWY. DIR. E	DISTANCE FROM Feet Miles	LOCATION <input type="checkbox"/> NA <input checked="" type="checkbox"/> After <input type="checkbox"/> Before <input type="checkbox"/> At	INTERSECTING RP 6282
SPEED LIMIT 60	ROAD MAINTAINED BY <input checked="" type="checkbox"/> State <input type="checkbox"/> County <input type="checkbox"/> Municipal <input type="checkbox"/> Private Property <input type="checkbox"/> Other		0.2		SPEED LIMIT NA
					INT. DIR. W
					GEO - CODE NA

ON IS 44		RDWY. DIR. E	DISTANCE FROM Feet Miles	LOCATION <input type="checkbox"/> NA <input checked="" type="checkbox"/> After <input type="checkbox"/> Before <input type="checkbox"/> At	INTERSECTING RP 279360 (WJ)
SPEED LIMIT 60	ROAD MAINTAINED BY <input checked="" type="checkbox"/> State <input type="checkbox"/> County <input type="checkbox"/> Municipal <input type="checkbox"/> Private Property <input type="checkbox"/> Other		0.2		SPEED LIMIT NA
					INT. DIR. E
					GEO - CODE NA

**Crash "D":**

Crash "D" is located On Ramp 279360 (Roadway Direction - "E") and can be measured back to the gore with IS 44 E or to the gore with IS 270 E.

ON RP 279360		RDWY. DIR. E	DISTANCE FROM Feet Miles	LOCATION <input type="checkbox"/> NA <input checked="" type="checkbox"/> After <input type="checkbox"/> Before <input type="checkbox"/> At	INTERSECTING IS 44
SPEED LIMIT 60	ROAD MAINTAINED BY <input checked="" type="checkbox"/> State <input type="checkbox"/> County <input type="checkbox"/> Municipal <input type="checkbox"/> Private Property <input type="checkbox"/> Other		0.5		SPEED LIMIT NA
					INT. DIR. E
					GEO - CODE NA

ON RP 279360		RDWY. DIR. E	DISTANCE FROM Feet Miles	LOCATION <input type="checkbox"/> NA <input checked="" type="checkbox"/> Before <input type="checkbox"/> At	INTERSECTING IS 270
SPEED LIMIT 60	ROAD MAINTAINED BY <input checked="" type="checkbox"/> State <input type="checkbox"/> County <input type="checkbox"/> Municipal <input type="checkbox"/> Private Property <input type="checkbox"/> Other		0.1		SPEED LIMIT NA
					INT. DIR. E
					GEO - CODE NA

## JUNCTIONS

When two roadways with the same name intersect more than once within a county, a designation showing which junction is being referenced must be entered in the "Intersecting" field after the roadway name. The appropriate letter or numerical value as found in the [MoDOT Interactive Mapping Tool](#) must be used.

### Two or three intersections:

If two or three intersections, use the appropriate letters from the [MoDOT Interactive Mapping Tool](#). Use (NJ) - North Junction, (SJ) - South Junction, (EJ) - East Junction, (WJ) - West Junction, (MJ) - Middle Junction to indicate the junction being referenced.

<u>RT B N</u>		<u>(7370)</u>	
<u>BEGIN</u>	<u>AUDRAIN</u>	<u>COUNTY</u>	
<u>US</u>	<u>54</u>	<u>(E)</u>	
<u>CRD</u>	<u>412</u>	<u>(E)</u>	
<u>CST</u>	<u>CHURCH ST</u>	<u>(E)</u>	
<u>CST</u>	<u>MAIN ST</u>	<u>(E)</u>	
<u>CST</u>	<u>SECOND ST</u>	<u>(E)</u>	
<u>CST</u>	<u>FIFTH ST</u>	<u>(E)</u>	
<u>CST</u>	<u>SIXTH ST</u>	<u>(E)</u>	
<u>RT</u>	<u>KK</u>	<u>(E)</u>	<u>(SJ)</u>
<u>RT</u>	<u>KK</u>	<u>(E)</u>	<u>(NJ)</u>
<u>CRD</u>	<u>9446</u>	<u>(E)</u>	
<u>CRD</u>	<u>448</u>	<u>(E)</u>	
<u>BRIDGE</u>	<u>T0208</u>	<u>W LICK CR</u>	
<u>RT</u>	<u>J</u>	<u>(E)</u>	<u>(SJ)</u>
<u>BRIDGE</u>	<u>T0206</u>	<u>W LICK CR</u>	
<u>BRIDGE</u>	<u>T0207</u>	<u>BR W LICK CR</u>	
<u>RT</u>	<u>J</u>	<u>(E)</u>	<u>(NJ)</u>
<u>CRD</u>	<u>472</u>	<u>(E)</u>	
<u>CRD</u>	<u>480</u>	<u>(E)</u>	
<u>BRIDGE</u>	<u>T0205</u>	<u>BR LICK CR</u>	

In the example above RT B and RT KK overlap one another between the junctions.

### Crash "A":

Crash "A" is located in the intersection of RT B and the north junction with RT KK. The crash can be located On RT B (Roadway Direction - "N") At RT KK (NJ) (as shown in the example) or On RT KK (Roadway Direction - "E") At RT B (NJ) (Not shown).

ON	RDWY. DIR.	DISTANCE FROM	LOCATION	INTERSECTING
RT B	N	<input checked="" type="checkbox"/> NA Feet Miles	<input type="checkbox"/> After <input type="checkbox"/> Before <input checked="" type="checkbox"/> At	RT KK (NJ)
SPEED LIMIT	ROAD MAINTAINED BY			SPEED LIMIT
55	<input checked="" type="checkbox"/> State <input type="checkbox"/> County <input type="checkbox"/> Municipal <input type="checkbox"/> Private Property <input type="checkbox"/> Other			55
				INT. DIR.
				E
				GEO - CODE
				NA

### Crash "B":

Crash "B" can be located On RT B (Roadway Direction - "S"), 0.1 Mile Before the south junction with RT KK (as shown in the example) or On RT KK (Roadway Direction - "W"), 0.1 Mile Before the south junction with RT B (not shown).

ON	RDWY. DIR.	DISTANCE FROM	LOCATION	INTERSECTING
RT B	S	<input type="checkbox"/> NA Feet 0.1 Miles	<input type="checkbox"/> After <input checked="" type="checkbox"/> Before <input type="checkbox"/> At	RT KK (SJ)
SPEED LIMIT	ROAD MAINTAINED BY			SPEED LIMIT
55	<input checked="" type="checkbox"/> State <input type="checkbox"/> County <input type="checkbox"/> Municipal <input type="checkbox"/> Private Property <input type="checkbox"/> Other			55
				INT. DIR.
				W
				GEO - CODE
				NA

**Four or More Intersections:**

If four or more intersections, the [MoDOT Interactive Mapping Tool](#) MUST be used to obtain the appropriate numerical value assigned to the specific junction.

<b>MO 21 N</b>	(17)		<b>BRIDGE A6487</b> RT BB	
WASHINGTON/JEFFERSON COUNTY LINE			RT BB	(S)
BEGIN JEFFERSON	COUNTY		BEGIN HILLSBORO	CITY LIMITS
CRD BRITTON RD	(E)	(SJ)	BEGIN HILLSBORO	CITY LIMITS
CRD BRITTON RD	(E)	(NJ)	RT A	(E)
CRD PERKINS RD	(E)		BRIDGE A6779 SANDY CR	
CRD DODSON LN	(S)		BRIDGE A6483 CRD HAYDEN RD	
CRD BIG RIVER HEIGHTS RD	(E)		CRD HAYDEN RD	(E)
CRD GRASSY LN	(E)		CRD GLADE CHAPEL RD	(E)
CRD MOTHERSHEAD RD	(E)		CRD OLD HWY 21	(S) (20.901)
CRD VINELAND RD	(E)		BRIDGE A6056 CRD KLABLE RD	
BRIDGE L0013 WHITEHEAD CR			CRD KLABLE RD	(E)
CRD BRIGGS DR	(S)		CRD OLD HWY 21	(S) (23.488)
CRD LEMBECK LAKE RD	(E)		BRIDGE A2945 CRD HEADS CREEK RD	
CST VINELAND SCHOOL RD	(E)		CRD HEADS CREEK RD	(S)
CRD YELLOW ROCK RD	(E)		BRIDGE A5529 RT M	
CRD COLLEGE HEIGHTS RD	(E)		RT M	(E)
BEGIN DE SOTO	CITY LIMITS		RT M	(W)
BRIDGE L0012 TANYARD BR			CRD WEST FOUR RIDGE RD	(S)
CST AMVETS DR	(E)		BRIDGE A2942 CRD OLD HWY 21	
BEGIN DE SOTO	CITY LIMITS		CRD OLD HWY 21	(S) (28.668)
RT H	(E)		BRIDGE A2958 ROCK CR	
CST JEFFERSON DR	(S)	(SJ)	BRIDGE A2956 CRD OLD HWY 21	
CST JEFFERSON DR	(S)	(NJ)	CRD OLD HWY 21	(S) (30.267)
CST NEW BOYD STREET RD	(E)		CRD SWALLER RD	(S)
CST BOYD ST	(E)		CRD BLECHA RD	(S)
CRD UNKNOWN	(S)		CRD ROCK CREEK RD	(E)
PVT WALMART	(E)		CRD OLD HWY 21	(S) (31.446)
BEGIN DE SOTO	CITY LIMITS		BRIDGE A3098 CRD LONEDELL RD	
RT X	(E)		CRD LONEDELL RD	(E)
			W OR 21	(S)

For example, there are five junctions of CRD Old Hwy 21 with MO 21 in Jefferson County. A crash occurring within the intersection at the first junction listed would be shown in *Section 2 - Location* as follows:

ON	RDWY. DIR.	DISTANCE FROM	LOCATION	INTERSECTING
MO 21	N	<input checked="" type="checkbox"/> NA Feet <input type="checkbox"/> Miles	<input type="checkbox"/> After <input type="checkbox"/> NA <input type="checkbox"/> Before <input checked="" type="checkbox"/> At	CRD Old Hwy 21 (20.901)
SPEED LIMIT	ROAD MAINTAINED BY			SPEED LIMIT INT. DIR. GEO - CODE
65	<input checked="" type="checkbox"/> State <input type="checkbox"/> County <input type="checkbox"/> Municipal <input type="checkbox"/> Private Property <input type="checkbox"/> Other			45 S NA

## BRIDGES

When locating crashes on or referenced to a bridge, the bridge number in the [MoDOT Interactive Mapping Tool](#) identifies the beginning of the bridge structure in conjunction with the direction of the roadway. Therefore, crashes must be measured to the BEGINNING (not the middle or end) of a bridge structure as it relates to the roadway direction entered in the "Rdwy Dir" field. The bridge structure does not include any attached guardrail or crash barriers.

### Example #1:

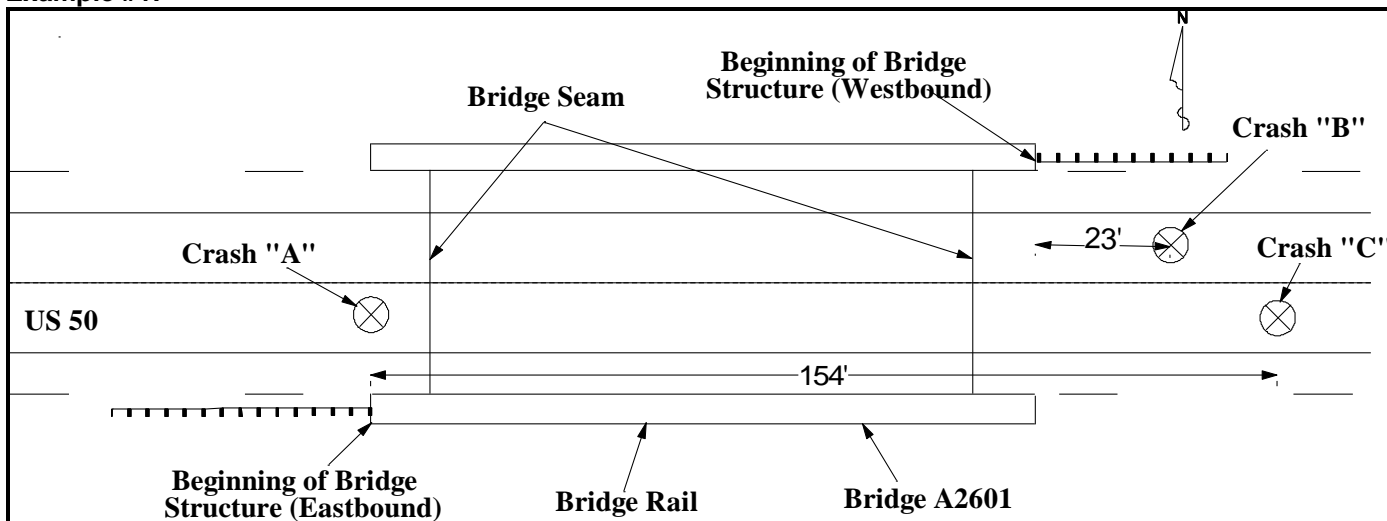

#### Crash "A":

Crash "A" occurred at the beginning of the bridge structure in the eastbound lane. The crash is located On US 50 (Roadway Direction - "E"), At BRIDGE A2601. "NA" is entered in the "Int Dir" field.

ON US 50		RDWY. DIR. E	DISTANCE FROM NA Feet Miles	LOCATION <input type="checkbox"/> After <input type="checkbox"/> NA <input checked="" type="checkbox"/> Before <input type="checkbox"/> At	INTERSECTING BRIDGE A2601	SPEED LIMIT NA	INT. DIR. NA	GEO - CODE NA
SPEED LIMIT 60	ROAD MAINTAINED BY <input checked="" type="checkbox"/> State <input type="checkbox"/> County <input type="checkbox"/> Municipal <input type="checkbox"/> Private Property <input type="checkbox"/> Other							

#### Crash "B":

Crash "B" occurred in the westbound lane prior to the bridge structure. The crash is located On US 50 (Roadway Direction - "W"), 23 Feet Before BRIDGE A2601. "NA" is entered in the "Int Dir" field.

ON US 50		RDWY. DIR. W	DISTANCE FROM 23 Feet Miles	LOCATION <input type="checkbox"/> After <input type="checkbox"/> NA <input checked="" type="checkbox"/> Before <input type="checkbox"/> At	INTERSECTING BRIDGE A2601	SPEED LIMIT NA	INT. DIR. NA	GEO - CODE NA
SPEED LIMIT 60	ROAD MAINTAINED BY <input checked="" type="checkbox"/> State <input type="checkbox"/> County <input type="checkbox"/> Municipal <input type="checkbox"/> Private Property <input type="checkbox"/> Other							

#### Crash "C":

Crash "C" occurred in the eastbound lane after the bridge structure. The crash is located On US 50 (Roadway Direction - "E"), 154 Feet After BRIDGE A2601. "NA" is entered in the "Int. Dir" field.

ON US 50		RDWY. DIR. E	DISTANCE FROM 154 Feet Miles	LOCATION <input checked="" type="checkbox"/> After <input type="checkbox"/> NA <input type="checkbox"/> Before <input type="checkbox"/> At	INTERSECTING BRIDGE A2601	SPEED LIMIT NA	INT. DIR. NA	GEO - CODE NA
SPEED LIMIT 60	ROAD MAINTAINED BY <input checked="" type="checkbox"/> State <input type="checkbox"/> County <input type="checkbox"/> Municipal <input type="checkbox"/> Private Property <input type="checkbox"/> Other							

**REST AREAS and WEIGH STATIONS**

The method for locating crashes on weight station or rest area lots is the same. The crash location is measured to the nearest entrance into the lot or the nearest exit from the lot.

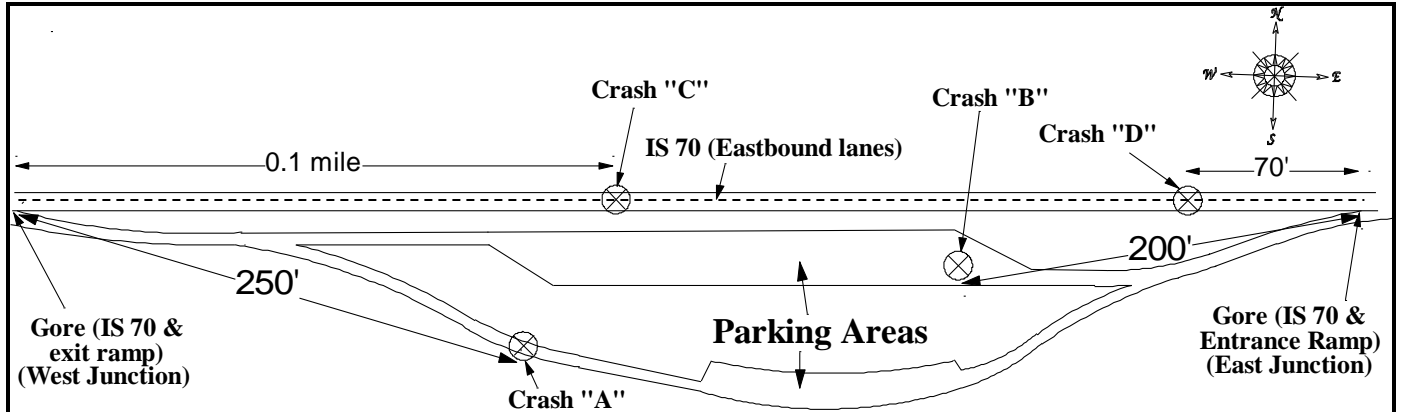

**IS 70 E (Montgomery County)**

<u>RT</u>	<u>N</u>		<u>(S)</u>
<u>RA</u>	<u>IS70E MINEOLA</u>		<u>(E)</u> <u>(WJ)</u>
<u>RA</u>	<u>IS70E MINEOLA</u>		<u>(E)</u> <u>(EJ)</u>
<u>BRIDGE</u>	<u>L0395</u>	<u>LOUTRE RVR OVRFL</u>	

**IS 70 E (Lafayette County)**

<u>BRIDGE</u>	<u>A0094</u>	<u>WITCHET CR</u>	
<u>WS</u>	<u>IS70E MAYVIEW</u>		<u>(E)</u> <u>(WJ)</u>
<u>WS</u>	<u>IS70E MAYVIEW</u>		<u>(E)</u> <u>(EJ)</u>
<u>BRIDGE</u>	<u>A0077</u>	<u>CRD UNDERPASS RD</u>	

**Crash "A":**

Assume Crash "A" occurred in the Mineola rest area on Interstate 70 in Montgomery County. Crash "A" is located On RA IS70E Mineola (Roadway Direction - "E"), 250 Feet After IS 70 (WJ) (shown below). The name of the rest area was obtained from the [MoDOT Interactive Mapping Tool](#) (shown above).

ON RA IS70E Mineola		RDWY. DIR. E	DISTANCE FROM 250 <input type="checkbox"/> NA Feet _____ Miles	LOCATION <input checked="" type="checkbox"/> After <input type="checkbox"/> Before <input type="checkbox"/> At <input type="checkbox"/> NA	INTERSECTING IS 70 (WJ)
SPEED LIMIT NA	ROAD MAINTAINED BY <input checked="" type="checkbox"/> State <input type="checkbox"/> County <input type="checkbox"/> Municipal <input type="checkbox"/> Private Property <input type="checkbox"/> Other				SPEED LIMIT NA
TRAFFICWAY <input checked="" type="checkbox"/> One-Way <input type="checkbox"/> Two-Way; Not Divided <input type="checkbox"/> Two-Way; Divided; Unprotected Median <input type="checkbox"/> Other <input type="checkbox"/> Two-Way; Not Divided; Continuous Center Turn Lane <input type="checkbox"/> Two-Way; Divided; Positive Median Barrier <input type="checkbox"/> Unknown			ROAD ALIGNMENT <input checked="" type="checkbox"/> Straight <input type="checkbox"/> Curve <input type="checkbox"/> Unknown (Explain)	ROAD PROFILE <input checked="" type="checkbox"/> Level <input type="checkbox"/> Downhill <input type="checkbox"/> Dip <input type="checkbox"/> Uphill <input type="checkbox"/> Hillcrest <input type="checkbox"/> Unknown (Explain)	

**Crash "B":**

Assume Crash "B" occurred on the Mayview weigh station lot on Interstate 70 in Lafayette County. Crash "B" is located On WS IS70E Mayview (Roadway Direction - "E"), 200 Feet Before IS 70 (EJ) (shown below). The name of the weigh station was obtained from the [MoDOT Interactive Mapping Tool](#) (shown above).

ON WS IS70E Mayview		RDWY. DIR. E	DISTANCE FROM 200 <input type="checkbox"/> NA Feet _____ Miles	LOCATION <input type="checkbox"/> After <input type="checkbox"/> NA <input checked="" type="checkbox"/> Before <input type="checkbox"/> At	INTERSECTING IS 70 (EJ)
SPEED LIMIT NA	ROAD MAINTAINED BY <input checked="" type="checkbox"/> State <input type="checkbox"/> County <input type="checkbox"/> Municipal <input type="checkbox"/> Private Property <input type="checkbox"/> Other				SPEED LIMIT NA
TRAFFICWAY <input checked="" type="checkbox"/> One-Way <input type="checkbox"/> Two-Way; Not Divided <input type="checkbox"/> Two-Way; Divided; Unprotected Median <input type="checkbox"/> Other <input type="checkbox"/> Two-Way; Not Divided; Continuous Center Turn Lane <input type="checkbox"/> Two-Way; Divided; Positive Median Barrier <input type="checkbox"/> Unknown			ROAD ALIGNMENT <input checked="" type="checkbox"/> Straight <input type="checkbox"/> Curve <input type="checkbox"/> Unknown (Explain)		ROAD PROFILE <input type="checkbox"/> Level <input type="checkbox"/> Downhill <input type="checkbox"/> Dip <input type="checkbox"/> Uphill <input type="checkbox"/> Hillcrest <input type="checkbox"/> Unknown (Explain)

**Crash "C":**

Assume Crash "C" occurred adjacent to the Mineola rest area on Interstate 70 in Montgomery County. Crash "C" is located On IS 70 (Roadway Direction - "E"), 0.1 Mile After RA IS70E Mineola (WJ) (shown below). The name of the rest area was obtained from the [MoDOT Interactive Mapping Tool](#) (shown above).

ON IS 70		RDWY. DIR. E	DISTANCE FROM <input type="checkbox"/> NA 0.1 Feet Miles	LOCATION <input checked="" type="checkbox"/> After <input type="checkbox"/> NA <input type="checkbox"/> Before <input type="checkbox"/> At	INTERSECTING RA IS70E Mineola (WJ)
SPEED LIMIT 70	ROAD MAINTAINED BY <input checked="" type="checkbox"/> State <input type="checkbox"/> County <input type="checkbox"/> Municipal <input type="checkbox"/> Private Property <input type="checkbox"/> Other				SPEED LIMIT NA
					INT. DIR. E
					GEO - CODE NA

**Crash "D":**

Assume Crash "D" occurred adjacent to the Mayview weigh station lot on Interstate 70 in Lafayette County. Crash "D" is located On IS 70 (Roadway Direction - "E"), 70 Feet Before WS IS70E Mayview (EJ) (shown below). The name of the weigh station was obtained from the [MoDOT Interactive Mapping Tool](#) (shown above).

ON IS 70		RDWY. DIR. E	DISTANCE FROM 70 <input type="checkbox"/> NA Feet _____ Miles	LOCATION <input type="checkbox"/> After <input type="checkbox"/> NA <input checked="" type="checkbox"/> Before <input type="checkbox"/> At	INTERSECTING WS IS70E Mayview (EJ)
SPEED LIMIT 70	ROAD MAINTAINED BY <input checked="" type="checkbox"/> State <input type="checkbox"/> County <input type="checkbox"/> Municipal <input type="checkbox"/> Private Property <input type="checkbox"/> Other				SPEED LIMIT NA
					INT. DIR. E
					GEO - CODE NA

## REVERSIBLE LANES

A reversible lane or roadway is one in which traffic may travel in either direction, depending on certain conditions. As of the publication of this preparation manual, the only reversible in Missouri is on IS-70 in the City of St. Louis. The information from the [MoDOT Interactive Mapping Tool](#) is shown below. The “Roadway Direction” on a crash occurring on the reversible will depend on the direction traffic was flowing at the time of the crash.

<b>RV 70 W</b>		(7836)	
IS	70	(W)	(EJ)
CST	BROADWAY	(S)	
CST	CASS AVE	(E)	
CST	N 7TH BLVD	(S)	
CST	HOWARD ST	(E)	
CST	9TH ST	(S)	
CST	MADISON ST	(E)	
PED	NORTH MARKET PL OVERPASS	(E)	
CST	ST LOUIS AVE	(E)	
CST	BRANCH ST	(E)	
MO	115	(S)	
CST	MC KINLEY BRG	(E)	
CST	ANGELICA ST	(E)	
CST	GRAND AVE	(E)	
CST	ADELAIDE AVE	(E)	
CST	CARRIE AVE	(E)	
CST	TAYLOR AVE	(E)	
CST	WEST FLORISSANT AVE	(S)	
CST	SHREVE AVE	(S)	
CST	KINGSHIGHWAY BLVD	(S)	
CST	UNION BLVD	(S)	
IS	70	(W)	(WJ)

<b>RV 70 E</b>		(7835)	
IS	70	(E)	(WJ)
CST	UNION BLVD	(S)	
CST	KINGSHIGHWAY BLVD	(S)	
CST	SHREVE AVE	(S)	
CST	WEST FLORISSANT AVE	(S)	
CST	TAYLOR AVE	(E)	
CST	CARRIE AVE	(E)	
CST	ADELAIDE AVE	(E)	
CST	GRAND AVE	(E)	
CST	ANGELICA ST	(E)	
CST	MC KINLEY BRG	(E)	
MO	115	(S)	
CST	BRANCH ST	(E)	
CST	ST LOUIS AVE	(E)	
PED	NORTH MARKET PL OVERPASS	(E)	
CST	MADISON ST	(E)	
CST	9TH ST	(S)	
CST	HOWARD ST	(E)	
CST	N 7TH BLVD	(S)	
CST	CASS AVE	(E)	
CST	BROADWAY	(S)	
IS	70	(E)	(EJ)

A crash that occurred on the reversible when traffic was flowing East, 0.233 Mile After Kingshighway Boulevard would be shown in *Section 2 - Location* as follows:

ON RV 70		RDWY. DIR. E	DISTANCE FROM <input type="checkbox"/> NA Feet 0.233 Miles	LOCATION <input checked="" type="checkbox"/> After <input type="checkbox"/> Before <input type="checkbox"/> At	INTERSECTING Kingshighway BLVD
SPEED LIMIT 60	ROAD MAINTAINED BY <input checked="" type="checkbox"/> State <input type="checkbox"/> County <input type="checkbox"/> Municipal <input type="checkbox"/> Private Property <input type="checkbox"/> Other				SPEED LIMIT NA
TRAFFICWAY <input checked="" type="checkbox"/> One-Way <input type="checkbox"/> Two-Way; Not Divided <input type="checkbox"/> Two-Way; Divided; Unprotected Median <input type="checkbox"/> Other <input type="checkbox"/> Two-Way; Not Divided; Continuous Center Turn Lane <input type="checkbox"/> Two-Way; Divided; Positive Median Barrier <input type="checkbox"/> Unknown		ROAD ALIGNMENT <input checked="" type="checkbox"/> Straight <input type="checkbox"/> Curve <input type="checkbox"/> Unknown (Explain)		ROAD PROFILE <input checked="" type="checkbox"/> Level <input type="checkbox"/> Downhill <input type="checkbox"/> Dip <input type="checkbox"/> Uphill <input type="checkbox"/> Hillcrest <input type="checkbox"/> Unknown (Explain)	
				INT. DIR. S	GEO - CODE NA



## DRIVEWAY ACCESS

A **driveway access** is a portion of the **trafficway** at the end of a driveway providing access to property adjacent to a trafficway. A driveway access is not considered an intersection. See the **definition** and examples in the glossary on page 13

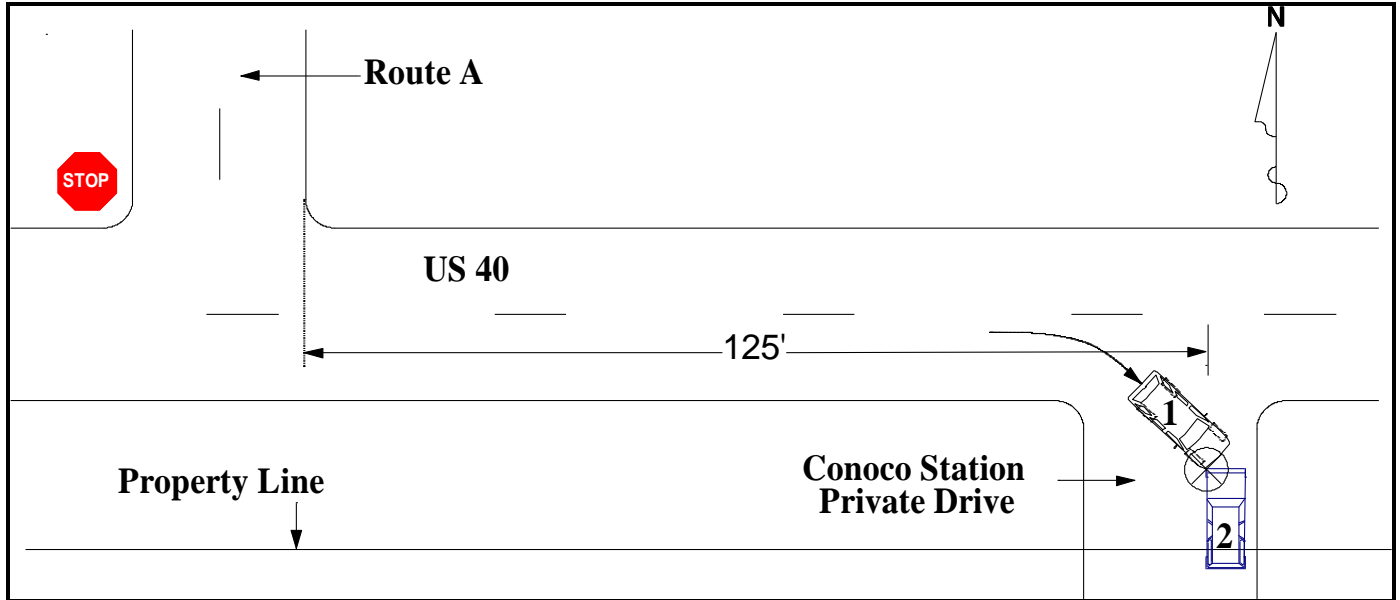

The crash above is located on US 40 because it occurred within the trafficway (right-of-way) of US 40. The private drive is not used in the "Intersecting" field because it provides access to the Conoco Station driveway. In the example, the crash is considered Off Roadway because the first harmful event was impact with a Motor Vehicle in Transport (Front to Front) off of US 40.

CRASH TYPE	ROADWAY	NON-COLLISION		COLLISION INVOLVING		DIRECTIONAL ANALYSIS FOR IMPACT WITH MOTOR VEHICLE		
	<input type="checkbox"/> On Roadway <input checked="" type="checkbox"/> Off Roadway	<input type="checkbox"/> Overturning <input type="checkbox"/> Fire / Explosion <input type="checkbox"/> Immersion <input type="checkbox"/> Jackknife	<input type="checkbox"/> Fell/Jumped From MV <input type="checkbox"/> Cargo / Equip Loss / Shift <input type="checkbox"/> Other Non-Collision	<input type="checkbox"/> Animal <input type="checkbox"/> Pedalcycle <input type="checkbox"/> Fixed Object <input type="checkbox"/> Other Object <input type="checkbox"/> Pedestrian	<input type="checkbox"/> Railway Vehicle <input type="checkbox"/> Animal Drawn Veh / Animal Ridden Trans. <input checked="" type="checkbox"/> Motor Vehicle in Transport <input type="checkbox"/> Parked Motor Vehicle <input type="checkbox"/> Working Motor Vehicle	<input checked="" type="checkbox"/> Front to Front <input type="checkbox"/> Front to Rear <input type="checkbox"/> Rear to Rear <input type="checkbox"/> Rear to Side	<input type="checkbox"/> Angle <input type="checkbox"/> Sideswipe (Same Dir.) <input type="checkbox"/> Sideswipe (Opp. Dir.) <input type="checkbox"/> Falling / Shifting Cargo (Set in motion by MV)	<input type="checkbox"/> Other (Explain) <input type="checkbox"/> Unknown (Explain)

The crash is located on US 40 (Roadway Direction - "E"), 125 Feet After Route A. The direction of the intersecting roadway (Int. Dir.) is shown as "N" (northbound lane) because the location of the crash was measured to the northbound lane of Route A.

ON	US 40	RDWY. DIR.	E	DISTANCE FROM	125 Feet	LOCATION	<input checked="" type="checkbox"/> After <input type="checkbox"/> Before <input type="checkbox"/> At	INTERSECTING	RT A
SPEED LIMIT	60	ROAD MAINTAINED BY	<input checked="" type="checkbox"/> State <input type="checkbox"/> County <input type="checkbox"/> Municipal <input type="checkbox"/> Private Property <input type="checkbox"/> Other					SPEED LIMIT	NA
								INT. DIR.	N
								GEO - CODE	NA
TRAFFICWAY		<input type="checkbox"/> One-Way <input checked="" type="checkbox"/> Two-Way; Not Divided <input type="checkbox"/> Two-Way; Not Divided; Continuous Center Turn Lane		<input type="checkbox"/> Two-Way; Divided; Unprotected Median <input type="checkbox"/> Two-Way; Divided; Positive Median Barrier <input type="checkbox"/> Other <input type="checkbox"/> Unknown		ROAD ALIGNMENT		ROAD PROFILE	
INTERSECTION TYPE		<input checked="" type="checkbox"/> NA <input type="checkbox"/> 4-way Intersection <input type="checkbox"/> Y-Intersection <input type="checkbox"/> 5-way / More <input type="checkbox"/> T-Intersection <input type="checkbox"/> Roundabout <input type="checkbox"/> Other (Explain)		ROAD CONDITION		<input checked="" type="checkbox"/> Straight <input type="checkbox"/> Curve <input type="checkbox"/> Unknown (Explain)		<input checked="" type="checkbox"/> Level <input type="checkbox"/> Uphill <input type="checkbox"/> Downhill <input type="checkbox"/> Hillcrest <input type="checkbox"/> Dip <input type="checkbox"/> Unknown (Explain)	
				<input checked="" type="checkbox"/> Dry <input type="checkbox"/> Wet <input type="checkbox"/> Snow <input type="checkbox"/> Ice / Frost		<input type="checkbox"/> Slush <input type="checkbox"/> Mud / Dirt <input type="checkbox"/> Standing Water <input type="checkbox"/> Moving Water		<input type="checkbox"/> Sand / Gravel <input type="checkbox"/> Other (Explain)	

The sequence of events (Section 7C) for vehicle #1 is "Making Right Turn" (3) and "Collision Inv. MV in Transport" (34). The sequence of events for vehicle #2 is "Stopped in Traffic" (12) and "Collision Inv. MV in Transport" (34).

Vehicle #1

7C. VEHICLE ACTION / SEQUENCE OF EVENTS CODES	
SEQUENCE OF EVENTS CODES	Unknown
3	34

Vehicle #2

7C. VEHICLE ACTION / SEQUENCE OF EVENTS CODES	
SEQUENCE OF EVENTS CODES	Unknown
12	34

## PARKING LOTS / PRIVATE ROADS

See examples of [private property crashes](#) on page 43.

A parking lot is an area used primarily for parking road vehicles. When paved and marked it commonly includes parking stalls, parking lot aisles, and parking lot ways.

Parking lot ways are land ways used primarily for vehicle circulation within parking lots and for vehicular access to parking lot aisles. Parking lot ways in parking lots open to the public are trafficways.

Parking lot aisles are used primarily for vehicular access to parking stalls. Parking lot aisles are not trafficways.

Parking stalls are reserved primarily for parked road vehicles. Parking stalls are not trafficways.

**Example #1**

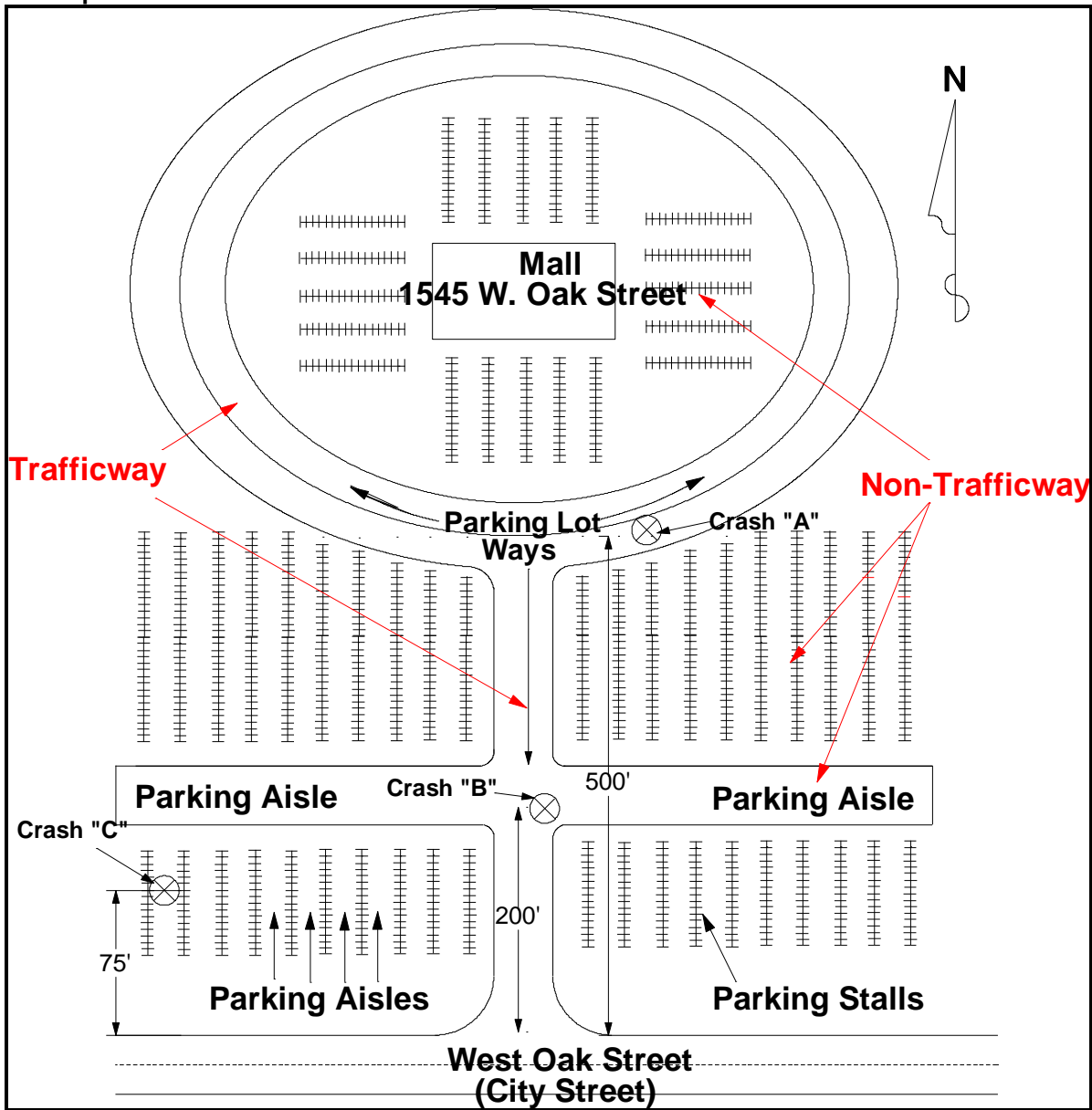

**Crash "A":**

Crash "A" occurred on the parking lot way, which is considered a trafficway. The crash is located On PP Parking Lot at 1545 West Oak ST (Roadway Direction - "NA"), 500 Feet North of CST West Oak ST. *Location* is shown as "NA" because the crash occurred on private property.

ON PP Parking Lot at 1545 West Oak ST		RDWY. DIR. NA	DISTANCE FROM 500 <input type="checkbox"/> NA Feet	LOCATION <input type="checkbox"/> After <input checked="" type="checkbox"/> NA <input type="checkbox"/> Before <input type="checkbox"/> At	INTERSECTING North of CST West Oak ST
SPEED LIMIT NA	ROAD MAINTAINED BY <input type="checkbox"/> Unknown <input type="checkbox"/> State <input type="checkbox"/> County <input type="checkbox"/> Municipal <input checked="" type="checkbox"/> Private Property <input type="checkbox"/> Other		_____ Miles		SPEED LIMIT NA
TRAFFICWAY <input type="checkbox"/> One-Way <input checked="" type="checkbox"/> Two-Way; Not Divided <input type="checkbox"/> Two-Way; Divided; Unprotected Median <input type="checkbox"/> Other <input type="checkbox"/> Two-Way; Not Divided; Continuous Center Turn Lane <input type="checkbox"/> Two-Way; Divided; Positive Median Barrier <input type="checkbox"/> Unknown			ROAD ALIGNMENT <input type="checkbox"/> Straight <input checked="" type="checkbox"/> Curve <input type="checkbox"/> Unknown (Explain)	ROAD PROFILE <input checked="" type="checkbox"/> Level <input type="checkbox"/> Downhill <input type="checkbox"/> Dip <input type="checkbox"/> Uphill <input type="checkbox"/> Hillcrest <input type="checkbox"/> Unknown (Explain)	

**Crash "B":**

Crash "B" occurred on the parking lot way, which is considered a trafficway. The crash is located On PP Parking Lot at 1545 West Oak ST (Roadway Direction - "NA"), 200 Feet North of CST West Oak ST. *Location* is shown as "NA" because the crash occurred on private property.

ON PP Parking Lot at 1545 West Oak ST		RDWY. DIR. NA	DISTANCE FROM 200 <input type="checkbox"/> NA Feet	LOCATION <input type="checkbox"/> After <input checked="" type="checkbox"/> NA <input type="checkbox"/> Before <input type="checkbox"/> At	INTERSECTING North of CST West Oak ST
SPEED LIMIT NA	ROAD MAINTAINED BY <input type="checkbox"/> Unknown <input type="checkbox"/> State <input type="checkbox"/> County <input type="checkbox"/> Municipal <input checked="" type="checkbox"/> Private Property <input type="checkbox"/> Other		_____ Miles		SPEED LIMIT NA
TRAFFICWAY <input type="checkbox"/> One-Way <input checked="" type="checkbox"/> Two-Way; Not Divided <input type="checkbox"/> Two-Way; Divided; Unprotected Median <input type="checkbox"/> Other <input type="checkbox"/> Two-Way; Not Divided; Continuous Center Turn Lane <input type="checkbox"/> Two-Way; Divided; Positive Median Barrier <input type="checkbox"/> Unknown			ROAD ALIGNMENT <input checked="" type="checkbox"/> Straight <input type="checkbox"/> Curve <input type="checkbox"/> Unknown (Explain)	ROAD PROFILE <input checked="" type="checkbox"/> Level <input type="checkbox"/> Downhill <input type="checkbox"/> Dip <input type="checkbox"/> Uphill <input type="checkbox"/> Hillcrest <input type="checkbox"/> Unknown (Explain)	

**Crash "C":**

Crash "C" occurred in a parking aisle, which is not considered a trafficway. The crash is located On PP Parking Lot at 1545 West Oak ST (Roadway Direction - "NA"), 75 Feet North of CST West Oak ST. *Location* is shown as "NA" because the crash occurred on private property.

ON PP Parking Lot at 1545 West Oak ST		RDWY. DIR. NA	DISTANCE FROM 75 <input type="checkbox"/> NA Feet	LOCATION <input type="checkbox"/> After <input checked="" type="checkbox"/> NA <input type="checkbox"/> Before <input type="checkbox"/> At	INTERSECTING North of CST West Oak ST
SPEED LIMIT NA	ROAD MAINTAINED BY <input type="checkbox"/> Unknown <input type="checkbox"/> State <input type="checkbox"/> County <input type="checkbox"/> Municipal <input checked="" type="checkbox"/> Private Property <input type="checkbox"/> Other		_____ Miles		SPEED LIMIT NA
TRAFFICWAY <input type="checkbox"/> One-Way <input type="checkbox"/> Two-Way; Not Divided <input type="checkbox"/> Two-Way; Divided; Unprotected Median <input checked="" type="checkbox"/> Other <input type="checkbox"/> Two-Way; Not Divided; Continuous Center Turn Lane <input type="checkbox"/> Two-Way; Divided; Positive Median Barrier <input type="checkbox"/> Unknown			ROAD ALIGNMENT <input checked="" type="checkbox"/> Straight <input type="checkbox"/> Curve <input type="checkbox"/> Unknown (Explain)	ROAD PROFILE <input checked="" type="checkbox"/> Level <input type="checkbox"/> Downhill <input type="checkbox"/> Dip <input type="checkbox"/> Uphill <input type="checkbox"/> Hillcrest <input type="checkbox"/> Unknown (Explain)	

**Example #2:**

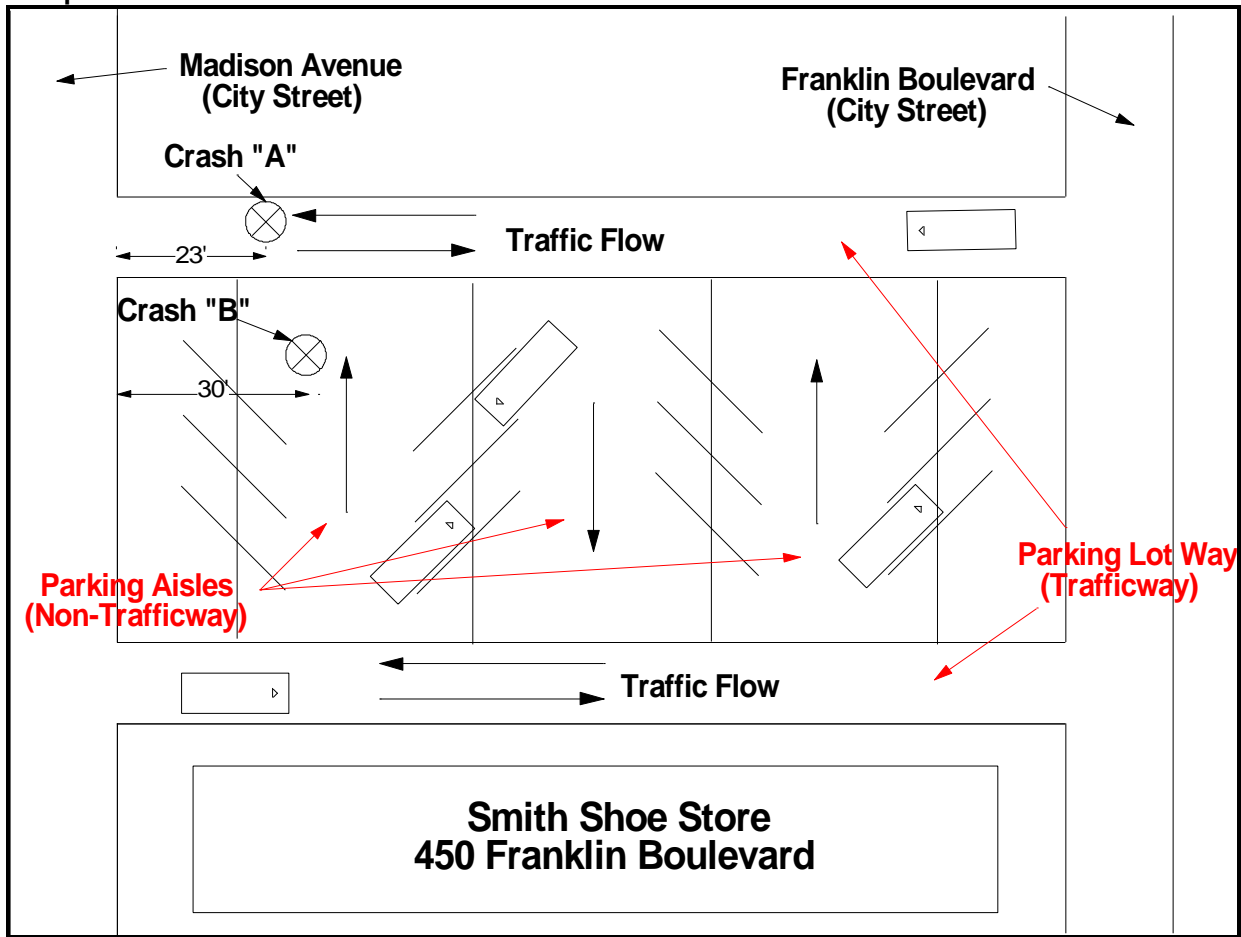

**Crash "A":**

Crash "A" occurred on a parking lot way, which is considered a trafficway. The crash is located On PP Parking Lot at 450 Franklin BLVD (Roadway Direction - "NA"), 23 Feet East of CST Madison AVE. *Location* is shown as "NA" because the crash occurred on private property.

ON PP Parking Lot at 450 Franklin BLVD		RDWY. DIR. NA	DISTANCE FROM 23 <input type="checkbox"/> NA Feet	LOCATION <input type="checkbox"/> After <input checked="" type="checkbox"/> NA <input type="checkbox"/> Before <input type="checkbox"/> At	INTERSECTING East of CST Madison AVE
SPEED LIMIT NA	ROAD MAINTAINED BY <input type="checkbox"/> Unknown <input type="checkbox"/> State <input type="checkbox"/> County <input type="checkbox"/> Municipal <input checked="" type="checkbox"/> Private Property <input type="checkbox"/> Other		_____ Miles		SPEED LIMIT INT. DIR. GEO - CODE NA NA NA
TRAFFICWAY <input type="checkbox"/> One-Way <input checked="" type="checkbox"/> Two-Way; Not Divided <input type="checkbox"/> Two-Way; Divided; Unprotected Median <input type="checkbox"/> Other <input type="checkbox"/> Two-Way; Not Divided; Continuous Center Turn Lane <input type="checkbox"/> Two-Way; Divided; Positive Median Barrier <input type="checkbox"/> Unknown			ROAD ALIGNMENT <input checked="" type="checkbox"/> Straight <input type="checkbox"/> Curve <input type="checkbox"/> Unknown (Explain)	ROAD PROFILE <input checked="" type="checkbox"/> Level <input type="checkbox"/> Downhill <input type="checkbox"/> Dip <input type="checkbox"/> Uphill <input type="checkbox"/> Hillcrest <input type="checkbox"/> Unknown (Explain)	

**Crash "B":**

Crash "B" occurred in the parking aisle, which is not considered a trafficway. The crash is located On PP Parking Lot at 450 Franklin BLVD (Roadway Direction - "NA"), 30 Feet East of CST Madison AVE. *Location* is shown as "NA" because the crash occurred on private property.

ON PP Parking Lot at 450 Franklin BLVD		RDWY. DIR. NA	DISTANCE FROM 30 <input type="checkbox"/> NA Feet	LOCATION <input type="checkbox"/> After <input checked="" type="checkbox"/> NA <input type="checkbox"/> Before <input type="checkbox"/> At	INTERSECTING East of CST Madison AVE
SPEED LIMIT NA	ROAD MAINTAINED BY <input type="checkbox"/> Unknown <input type="checkbox"/> State <input type="checkbox"/> County <input type="checkbox"/> Municipal <input checked="" type="checkbox"/> Private Property <input type="checkbox"/> Other		_____ Miles		SPEED LIMIT INT. DIR. GEO - CODE NA NA NA
TRAFFICWAY <input type="checkbox"/> One-Way <input type="checkbox"/> Two-Way; Not Divided <input type="checkbox"/> Two-Way; Divided; Unprotected Median <input checked="" type="checkbox"/> Other <input type="checkbox"/> Two-Way; Not Divided; Continuous Center Turn Lane <input type="checkbox"/> Two-Way; Divided; Positive Median Barrier <input type="checkbox"/> Unknown			ROAD ALIGNMENT <input checked="" type="checkbox"/> Straight <input type="checkbox"/> Curve <input type="checkbox"/> Unknown (Explain)	ROAD PROFILE <input checked="" type="checkbox"/> Level <input type="checkbox"/> Downhill <input type="checkbox"/> Dip <input type="checkbox"/> Uphill <input type="checkbox"/> Hillcrest <input type="checkbox"/> Unknown (Explain)	

**Example #3:**

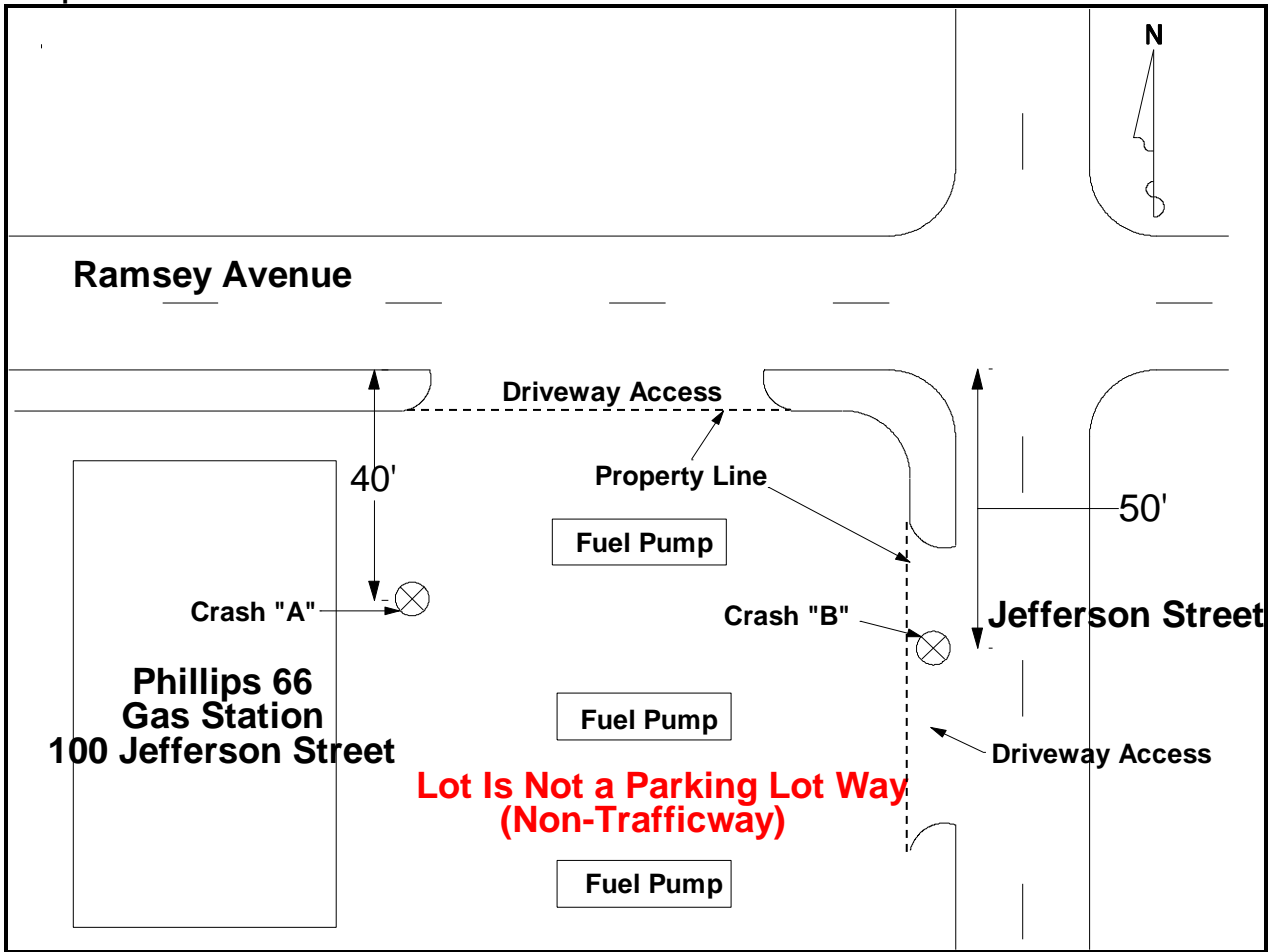

**Crash "A":**

Crash "A" occurred on the gas station parking lot, which is not considered a trafficway. The crash is located On Parking Lot at 100 Jefferson ST (Roadway Direction - "NA"), 40 Feet South of CST Ramsey AVE. Location is shown as "NA" because the crash occurred on private property.

ON PP Parking lot at 100 Jefferson ST		RDWY. DIR. NA	DISTANCE FROM 40 <input type="checkbox"/> NA Feet Miles	LOCATION <input type="checkbox"/> After <input checked="" type="checkbox"/> NA <input type="checkbox"/> Before <input type="checkbox"/> At	INTERSECTING South of CST Ramsey AVE
SPEED LIMIT NA	ROAD MAINTAINED BY <input type="checkbox"/> Unknown <input type="checkbox"/> State <input type="checkbox"/> County <input type="checkbox"/> Municipal <input checked="" type="checkbox"/> Private Property <input type="checkbox"/> Other				SPEED LIMIT NA
TRAFFICWAY <input type="checkbox"/> One-Way <input type="checkbox"/> Two-Way; Not Divided <input type="checkbox"/> Two-Way; Divided; Unprotected Median <input checked="" type="checkbox"/> Other <input type="checkbox"/> Two-Way; Not Divided; Continuous Center Turn Lane <input type="checkbox"/> Two-Way; Divided; Positive Median Barrier <input type="checkbox"/> Unknown		ROAD ALIGNMENT <input checked="" type="checkbox"/> Straight <input type="checkbox"/> Curve <input type="checkbox"/> Unknown (Explain)		ROAD PROFILE <input checked="" type="checkbox"/> Level <input type="checkbox"/> Downhill <input type="checkbox"/> Dip <input type="checkbox"/> Uphill <input type="checkbox"/> Hillcrest <input type="checkbox"/> Unknown (Explain)	

**Crash "B":**

Crash "B" occurred in the driveway access from Jefferson Street to the gas station parking lot. The driveway access is considered part of the trafficway. The crash is located On CST Jefferson ST (Roadway Direction - "S"), 50 Feet After CST Ramsey AVE. The direction of the intersecting roadway (Int. Dir.) is "E" because the location was measured to the eastbound lane of CST Ramsey AVE.

ON CST Jefferson ST		RDWY. DIR. S	DISTANCE FROM 50 <input type="checkbox"/> NA Feet Miles	LOCATION <input checked="" type="checkbox"/> After <input type="checkbox"/> NA <input type="checkbox"/> Before <input type="checkbox"/> At	INTERSECTING CST Ramsey AVE
SPEED LIMIT 30	ROAD MAINTAINED BY <input type="checkbox"/> Unknown <input type="checkbox"/> State <input type="checkbox"/> County <input checked="" type="checkbox"/> Municipal <input type="checkbox"/> Private Property <input type="checkbox"/> Other				SPEED LIMIT NA
TRAFFICWAY <input type="checkbox"/> One-Way <input checked="" type="checkbox"/> Two-Way; Not Divided <input type="checkbox"/> Two-Way; Divided; Unprotected Median <input type="checkbox"/> Other <input type="checkbox"/> Two-Way; Not Divided; Continuous Center Turn Lane <input type="checkbox"/> Two-Way; Divided; Positive Median Barrier <input type="checkbox"/> Unknown		ROAD ALIGNMENT <input checked="" type="checkbox"/> Straight <input type="checkbox"/> Curve <input type="checkbox"/> Unknown (Explain)		ROAD PROFILE <input checked="" type="checkbox"/> Level <input type="checkbox"/> Downhill <input type="checkbox"/> Dip <input type="checkbox"/> Uphill <input type="checkbox"/> Hillcrest <input type="checkbox"/> Unknown (Explain)	

**Example #4:**

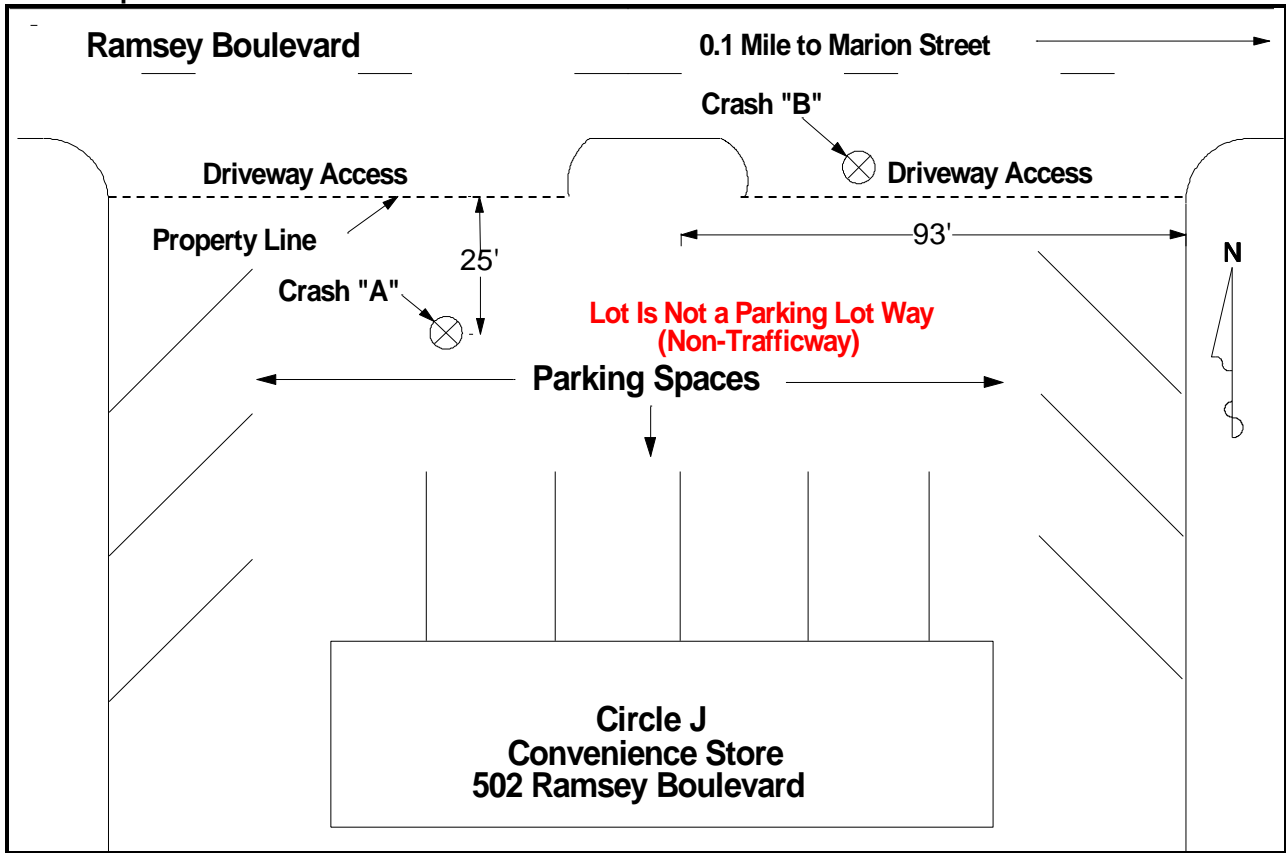

**Crash "A":**

Crash "A" occurred on the convenience store parking lot, which is not considered a trafficway. The crash is located On PP Parking Lot at 502 Ramsey BLVD (Roadway Direction - "NA"), 25 Feet South of CST Ramsey BLVD. Location is shown as "NA" because the crash occurred on private property.

ON PP Parking Lot at 502 Ramsey BLVD		RDWY. DIR. NA	DISTANCE FROM 25 <input type="checkbox"/> NA Feet	LOCATION <input type="checkbox"/> After <input checked="" type="checkbox"/> NA <input type="checkbox"/> Before <input type="checkbox"/> At	INTERSECTING South of CST Ramsey BLVD
SPEED LIMIT NA	ROAD MAINTAINED BY <input type="checkbox"/> Unknown <input type="checkbox"/> State <input type="checkbox"/> County <input type="checkbox"/> Municipal <input checked="" type="checkbox"/> Private Property <input type="checkbox"/> Other				SPEED LIMIT NA
TRAFFICWAY <input type="checkbox"/> One-Way <input type="checkbox"/> Two-Way; Not Divided <input type="checkbox"/> Two-Way; Divided; Unprotected Median <input checked="" type="checkbox"/> Other <input type="checkbox"/> Two-Way; Not Divided; Continuous Center Turn Lane <input type="checkbox"/> Two-Way; Divided; Positive Median Barrier <input type="checkbox"/> Unknown		ROAD ALIGNMENT <input checked="" type="checkbox"/> Straight <input type="checkbox"/> Curve <input type="checkbox"/> Unknown (Explain)		ROAD PROFILE <input checked="" type="checkbox"/> Level <input type="checkbox"/> Downhill <input type="checkbox"/> Dip <input type="checkbox"/> Uphill <input type="checkbox"/> Hillcrest <input type="checkbox"/> Unknown (Explain)	

**Crash "B":**

Crash "B" occurred in the driveway access from Ramsey Boulevard to the convenience store parking lot. The driveway access is considered part of the trafficway. The crash is located On CST Ramsey BLVD (Roadway Direction - "E"), 0.1 Mile Before CST Marion ST. The direction of the intersecting roadway (Int. Dir.) is "S" because the location was measured to the southbound lane of CST Marion ST.

ON CST Ramsey BLVD		RDWY. DIR. E	DISTANCE FROM <input type="checkbox"/> NA 0.1 Miles	LOCATION <input type="checkbox"/> After <input type="checkbox"/> NA <input checked="" type="checkbox"/> Before <input type="checkbox"/> At	INTERSECTING CST Marion ST
SPEED LIMIT 35	ROAD MAINTAINED BY <input type="checkbox"/> Unknown <input type="checkbox"/> State <input type="checkbox"/> County <input checked="" type="checkbox"/> Municipal <input type="checkbox"/> Private Property <input type="checkbox"/> Other				SPEED LIMIT NA
TRAFFICWAY <input type="checkbox"/> One-Way <input checked="" type="checkbox"/> Two-Way; Not Divided <input type="checkbox"/> Two-Way; Divided; Unprotected Median <input type="checkbox"/> Other <input type="checkbox"/> Two-Way; Not Divided; Continuous Center Turn Lane <input type="checkbox"/> Two-Way; Divided; Positive Median Barrier <input type="checkbox"/> Unknown		ROAD ALIGNMENT <input checked="" type="checkbox"/> Straight <input type="checkbox"/> Curve <input type="checkbox"/> Unknown (Explain)		ROAD PROFILE <input checked="" type="checkbox"/> Level <input type="checkbox"/> Downhill <input type="checkbox"/> Dip <input type="checkbox"/> Uphill <input type="checkbox"/> Hillcrest <input type="checkbox"/> Unknown (Explain)	

**Example #5:**

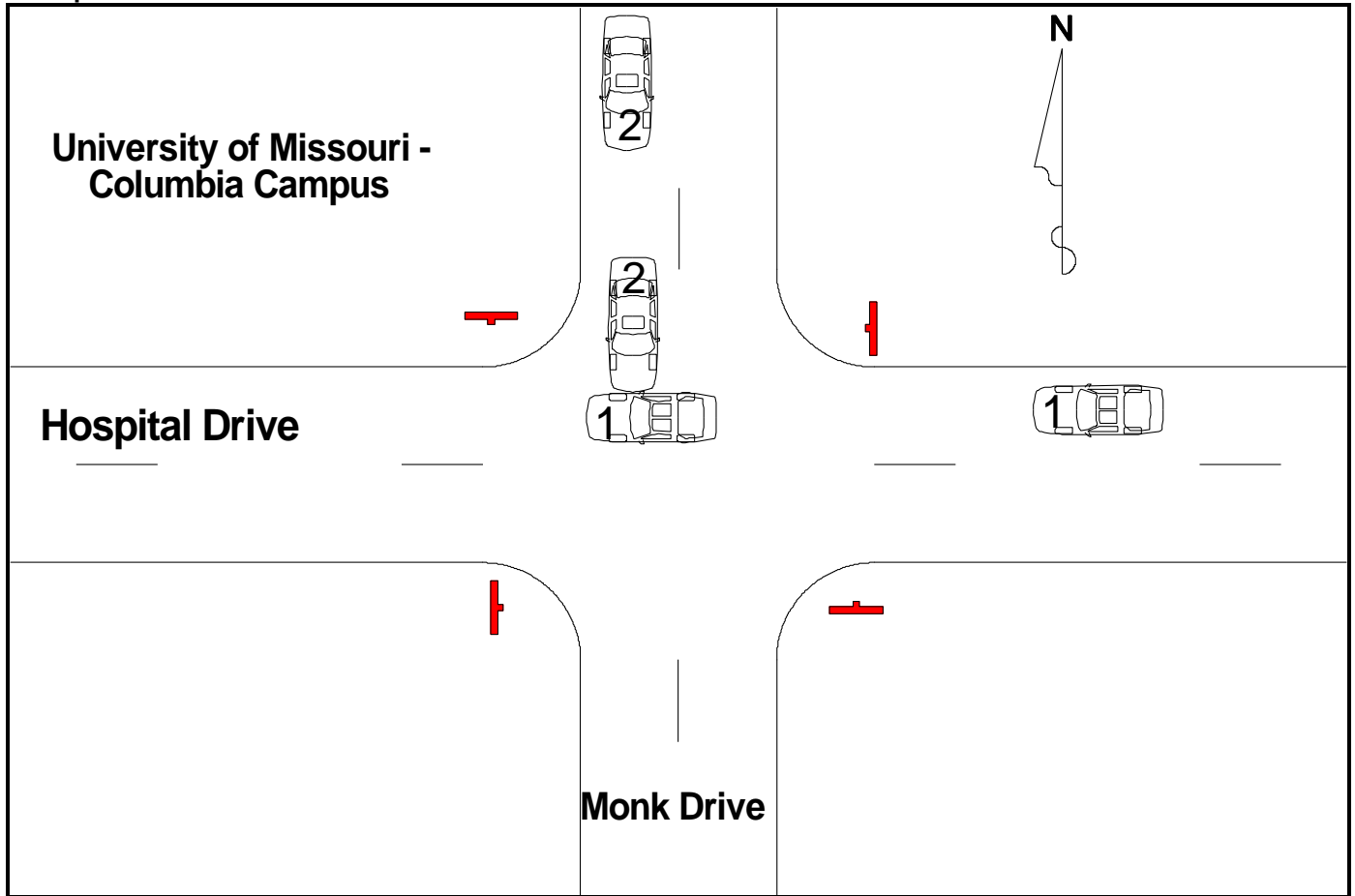

The roadways on the University of Missouri Campus are treated as private roadways even though they are maintained by the state. This occurs in several other locations such as other state college campuses, state parks, and other state-owned locations. In these cases, use the designator PVT.

The above crash is located On PVT Hospital DR (Roadway Direction - "W"), At PVT Monk DR. The direction of the intersecting roadway (Int. Dir.) can be shown either as "N" (northbound lane) or "S" (southbound lane) because it occurred within the intersection.

ON PVT Hospital DR		RDWY. DIR. W	DISTANCE FROM <input checked="" type="checkbox"/> NA ____ Feet ____ Miles	LOCATION <input type="checkbox"/> After <input type="checkbox"/> NA <input type="checkbox"/> Before <input checked="" type="checkbox"/> At	INTERSECTING PVT Monk DR
SPEED LIMIT 20	ROAD MAINTAINED BY <input checked="" type="checkbox"/> State <input type="checkbox"/> County <input type="checkbox"/> Municipal <input type="checkbox"/> Private Property <input type="checkbox"/> Other				SPEED LIMIT 20
					INT. DIR. S
					GEO - CODE NA
TRAFFICWAY <input type="checkbox"/> One-Way <input checked="" type="checkbox"/> Two-Way; Not Divided <input type="checkbox"/> Two-Way; Divided; Unprotected Median <input type="checkbox"/> Other <input type="checkbox"/> Two-Way; Not Divided; Continuous Center Turn Lane <input type="checkbox"/> Two-Way; Divided; Positive Median Barrier <input type="checkbox"/> Unknown		ROAD ALIGNMENT <input checked="" type="checkbox"/> Straight <input type="checkbox"/> Curve <input type="checkbox"/> Unknown (Explain)		ROAD PROFILE <input checked="" type="checkbox"/> Level <input type="checkbox"/> Downhill <input type="checkbox"/> Dip <input type="checkbox"/> Uphill <input type="checkbox"/> Hillcrest <input type="checkbox"/> Unknown (Explain)	
INTERSECTION TYPE <input checked="" type="checkbox"/> 4-way Intersection <input type="checkbox"/> Y-Intersection <input type="checkbox"/> 5-way / More <input type="checkbox"/> Unknown (Explain) <input type="checkbox"/> T-Intersection <input type="checkbox"/> Roundabout <input type="checkbox"/> Other (Explain)		ROAD CONDITION <input checked="" type="checkbox"/> Dry <input type="checkbox"/> Snow <input type="checkbox"/> Slush <input type="checkbox"/> Standing Water <input type="checkbox"/> Sand / Gravel <input type="checkbox"/> Unknown (Explain) <input type="checkbox"/> Wet <input type="checkbox"/> Ice / Frost <input type="checkbox"/> Mud / Dirt <input type="checkbox"/> Moving Water <input type="checkbox"/> Other (Explain)			

# APPENDIX F

## Miscellaneous

### TIME CHART

ORDINARY TIME	MILITARY TIME	ORDINARY TIME	MILITARY TIME
1 a.m.-----	0100	1 p.m.-----	1300
2 a.m.-----	0200	2 p.m.-----	1400
3 a.m.-----	0300	3 p.m.-----	1500
4 a.m.-----	0400	4 p.m.-----	1600
5 a.m.-----	0500	5 p.m.-----	1700
6 a.m.-----	0600	6 p.m.-----	1800
7 a.m.-----	0700	7 p.m.-----	1900
8 a.m.-----	0800	8 p.m.-----	2000
9 a.m.-----	0900	9 p.m.-----	2100
10 a.m.-----	1000	10 p.m.-----	2200
11 a.m.-----	1100	11 p.m.-----	2300
Noon-----	1200	Midnight-----	0000

### ROADWAY NAME ABBREVIATIONS

Avenue	AVE
Boulevard	BLVD
Circle	CIR
Court	CT
Cutoff	CUTOFF (Not abbreviated)
Drive	DR
Expressway	EXPY
Highway	HWY
Lane	LN
Parkway	PKWY
Place	PL
Road	RD
Street	ST
Terrace	TER
Trafficway	TRFY

### ROUTE DESIGNATION ABBREVIATIONS

IS	Interstate	CO	Connector for Wye Leg
US	U.S. Highway	EOR	East Outer Road
MO	State Numbered	NOR	North Outer Road
RT	State Lettered	SOR	South Outer Road
AL	Alternate Route	WOR	West Outer Road
LP	Loop (Interstates Only)	PVT	Private Road
BU	Business Route (US or MO only)	RV	Reversible
SP	Spur	RA	Rest Area
CST	City Street	WS	Weigh Station
RP	Ramp	ALY	Alley
CRD	County Road	BRIDGE	Bridge
PP	Private Property	ERM	Emergency Reference Marker
DOD	Department of Defense		



## VEHICLE COLOR ABBREVIATIONS

BGE	Beige	DBL	Dk. Blue	MAU	Mauve	SIL	Silver /
BLK	Black	DGR	Dk. Green	MUL	Multicolored		Aluminum
BLU	Blue	GLD	Gold	ONG	Orange	TAN	Tan
BRO	Brown	GRN	Green	ORC	Orchid	TAU	Taupe
BRZ	Bronze	GRY	Gray	PEA	Peach	TEA	Teal
CHA	Charcoal	LAV	Lavender	PEW	Pewter	TRQ	Turquoise
COM	Chrome /	LBL	Lt. Blue	PLE	Purple	WHI	White
	Stainless	LGR	Lt. Green	PNK	Pink	WIN	Wine
CPR	Copper	MAR	Maroon /	PRI	Primer	WOD	Woodgrain
CRM	Cream/Ivory		Burgundy	RED	Red	YEL	Yellow
				RUS	Rust	999	Unknown Color

## DIAGRAM OF A TRAFFICWAY

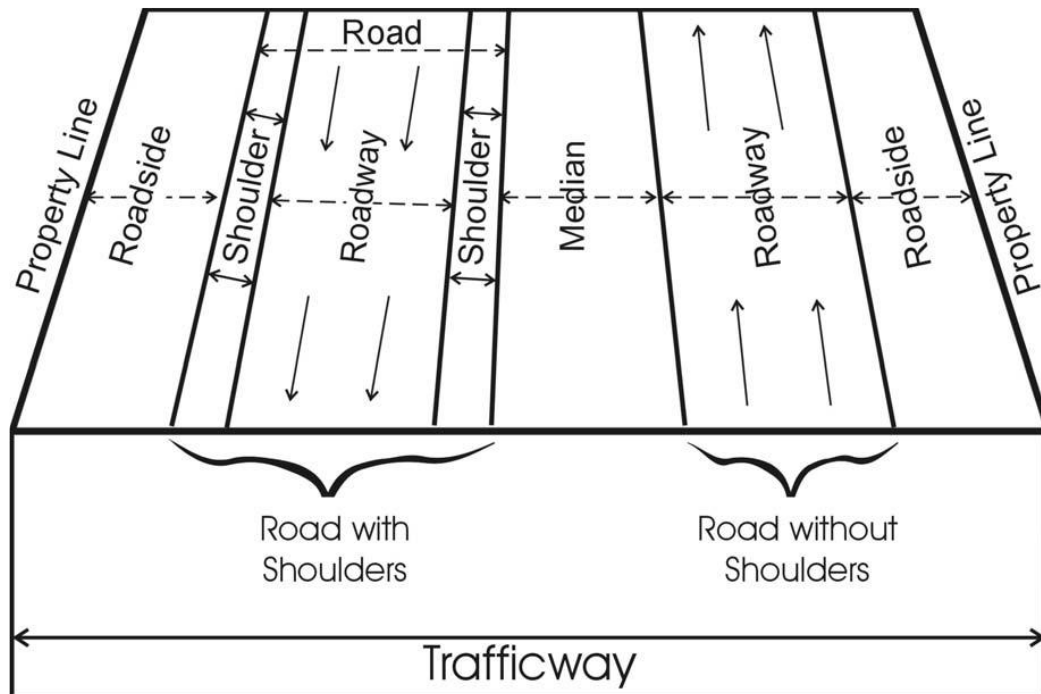

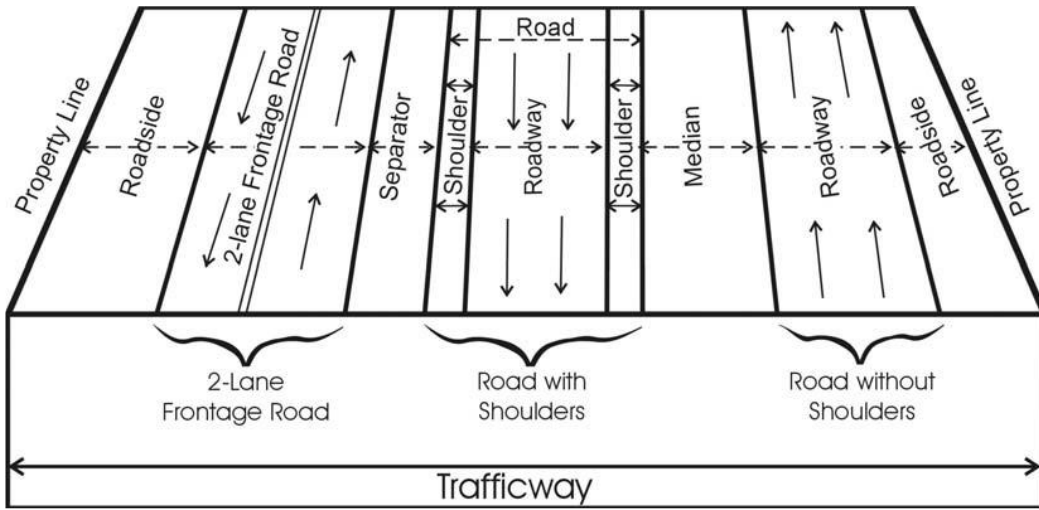

Trafficway with Frontage Road. Frontage road could be one or two-way.

(Source: ANSI D16.1-2007 Manual on Classification of Motor Vehicle Traffic Accidents, 7th Edition)

## APPENDIX G

### Driver License Status and Type

Specific Situations Concerning Lic. Status and Lic. Type

	Status	Type	M/C Endorsement
<b>Temporary Driving Permit / Privilege (Valid)</b>	Valid	(Type Issued)	
<b>Temporary Driving Permit / Privilege (Invalid)</b>	(Current Status)	(Type Issued)	
<b>Instruction Permit (Valid)</b>	Valid	Permit	
<b>Instruction Permit (Invalid)</b>	Canceled/Oth.Invalid	Permit	
<b>Limited Driving Privilege (Hardship Lic) - In Compliance with Permit</b>	Valid	(Type Issued)	
<b>Limited Driving Privilege (Hardship Lic) - Not In Compliance with Permit</b>	(Current Status)	(Type Issued)	
<b>Motorcycle Operator with valid MC permit</b>	Valid	Permit	No
<b>Motorcycle Operator with no permit or endorsement</b>	Canceled/Oth.Invalid	Unlicensed	No
<b>Interlock Required Operator (Installed or not-installed)</b>	(Current Status)	(Type Issued)	
<b>MO Resident with Out of State License</b>	(Current Status in State of Issuance)	(Current Type in State of Issuance)	
<b>Operator with an Assigned No. by DOR with Privelege Suspended, Revoked, Denied, etc.</b>	Suspended, Revoked, Denied....	Unlicensed	
<b>Operator with a license from a country other than U.S.</b>	Current status if known Unknown if cannot be determined	Type Issued if known Unknown if cannot be determined	